

LOTE 1

Seguí los
pasos
y armá tu
Placard **Velvet 180**



MÁS ESPACIO DE GUARDADO

COLGADO LARGO

COLGADO CORTO



**PERFILERÍA
ALUMINIO**

ESTANTES

CAJONES

Abrí la caja y posicioná
las piezas en el piso.

**CAJA 1
DE 3**

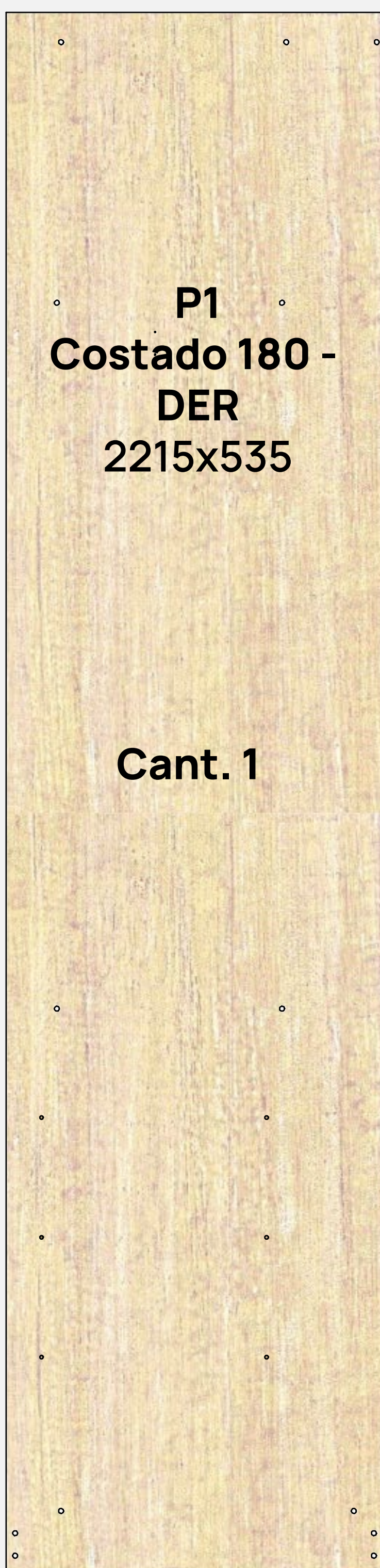

P1
Costado 180 -
DER
2215x535

Cant. 1

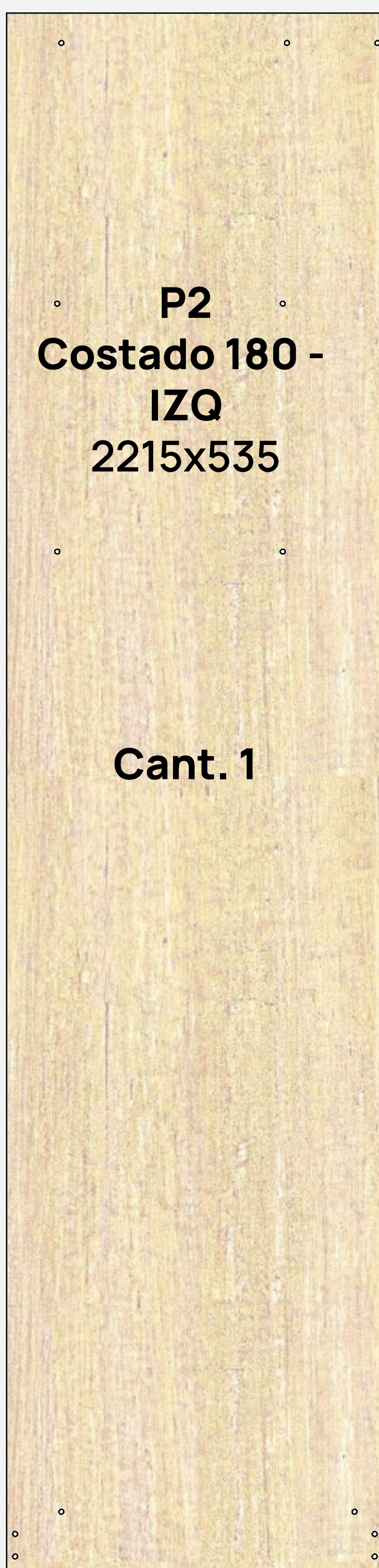

P2
Costado 180 -
IZQ
2215x535

Cant. 1

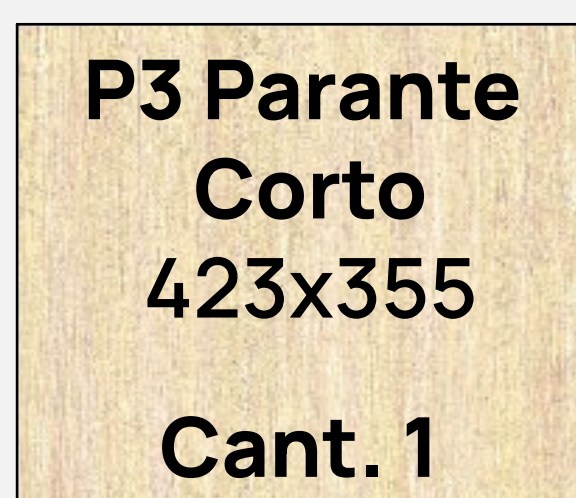

P3 Parante
Corto
423x355

Cant. 1

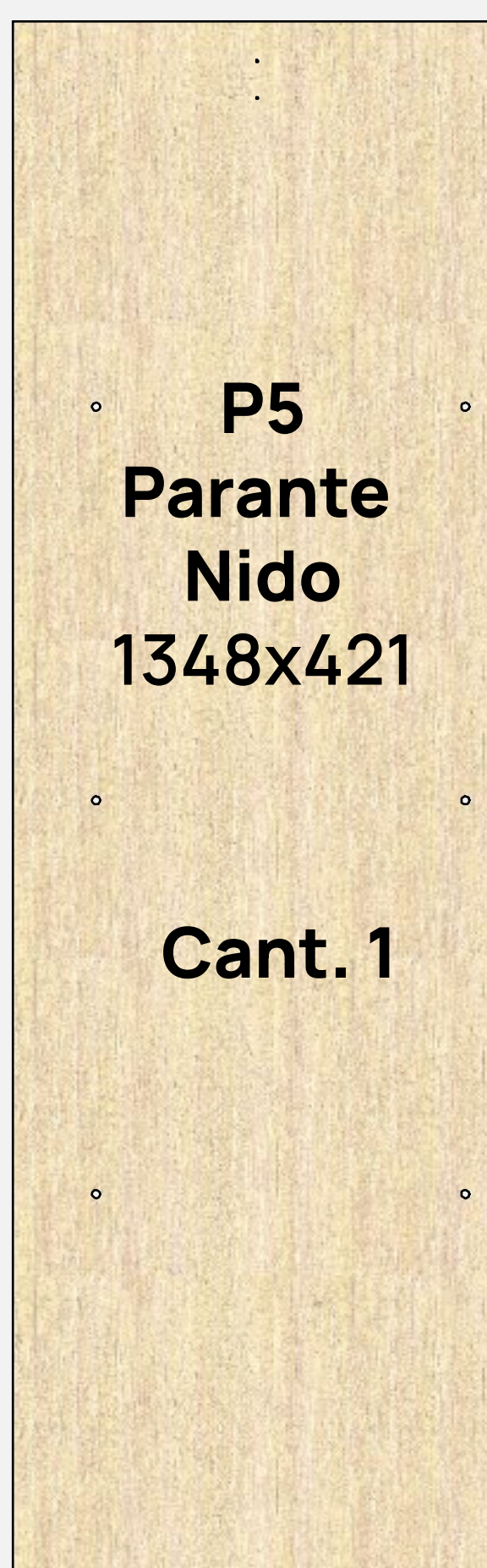

P5
Parante
Nido
1348x421

Cant. 1

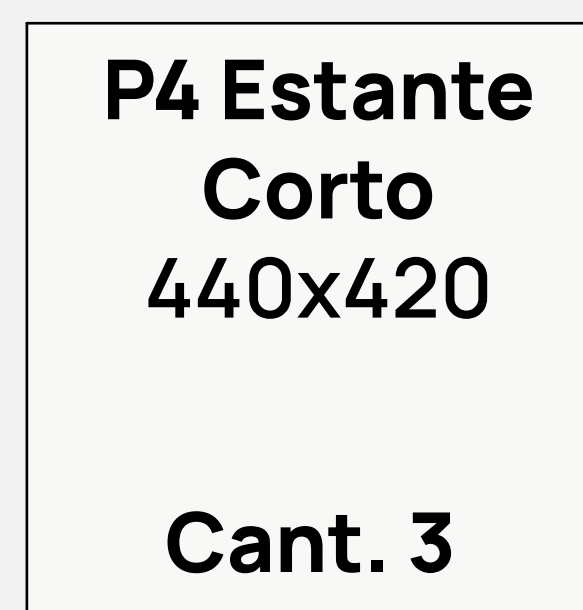

P4 Estante
Corto
440x420

Cant. 3

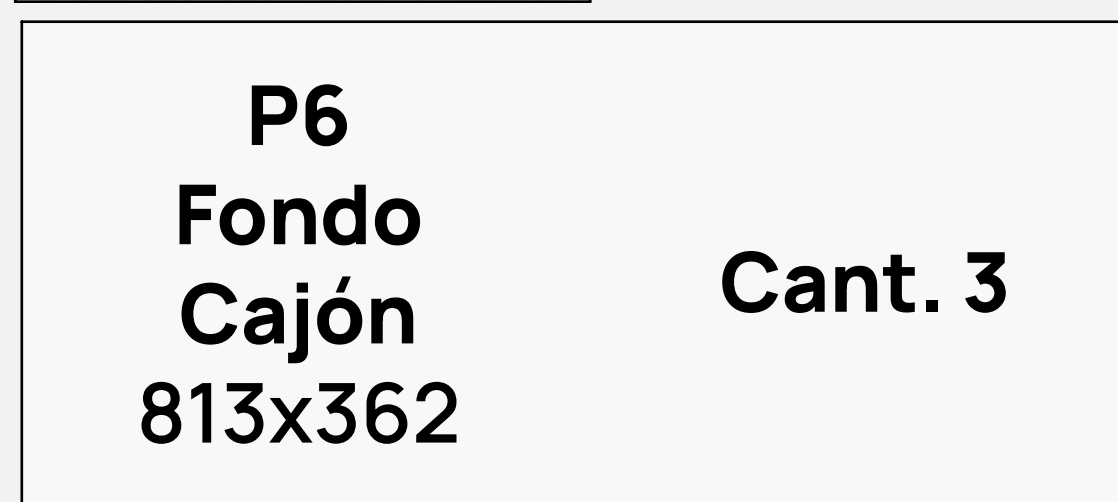

P6
Fondo
Cajón
813x362

Cant. 3



P7 Lateral cajón

355x120
Cant. 6

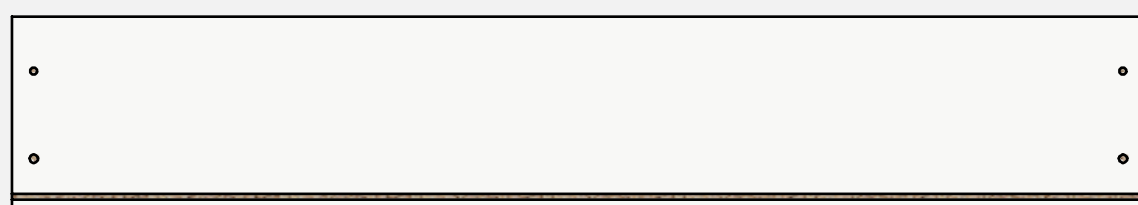

P8 Frente cajón

830x145
Cant. 3



P9 Contrafrente cajón

783x118
Cant. 3



P10 Zócalo Central

495x80
Cant. 1



Protección caja
No se usa en armado

P11 Puntera

530x70
Cant. 2



Barral de colgado - 433 - 832

Cant. 2

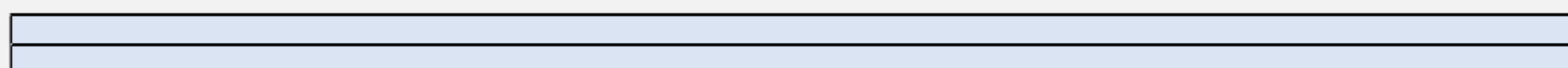

Guía superior aluminio - 1748

Cant. 1

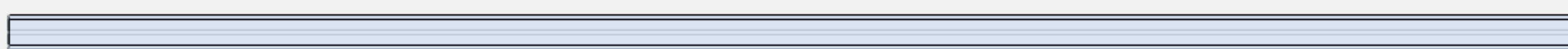

Guía inferior aluminio - 1748

Cant. 1

Abrí la caja y posicioná
las piezas en el piso.

**CAJA 2
DE 3**

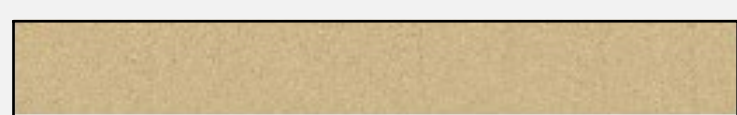
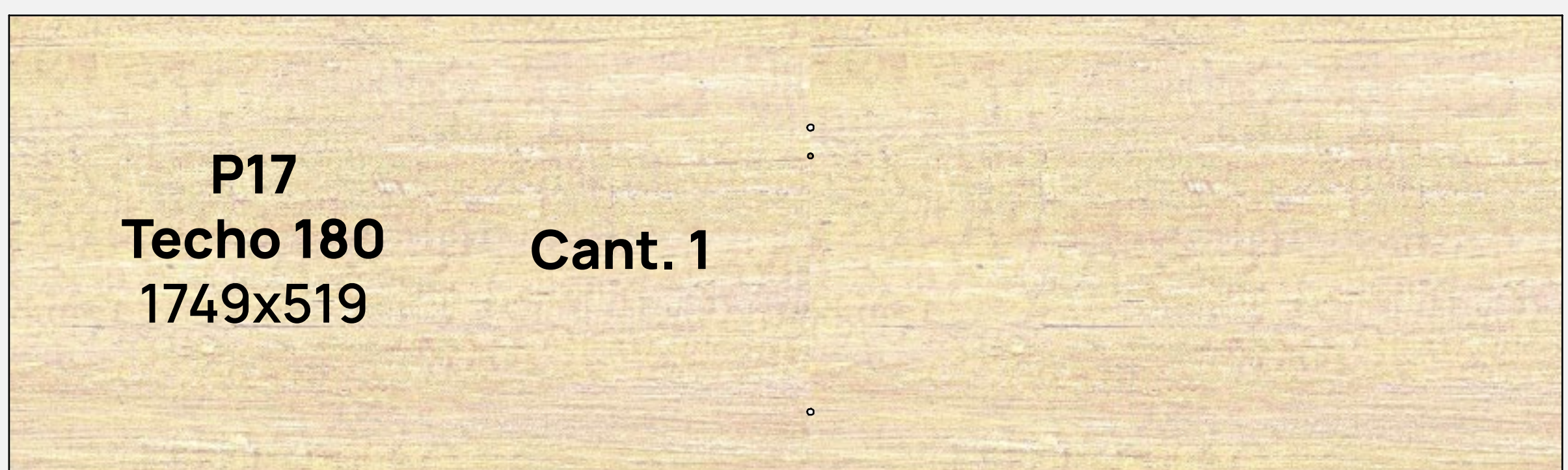
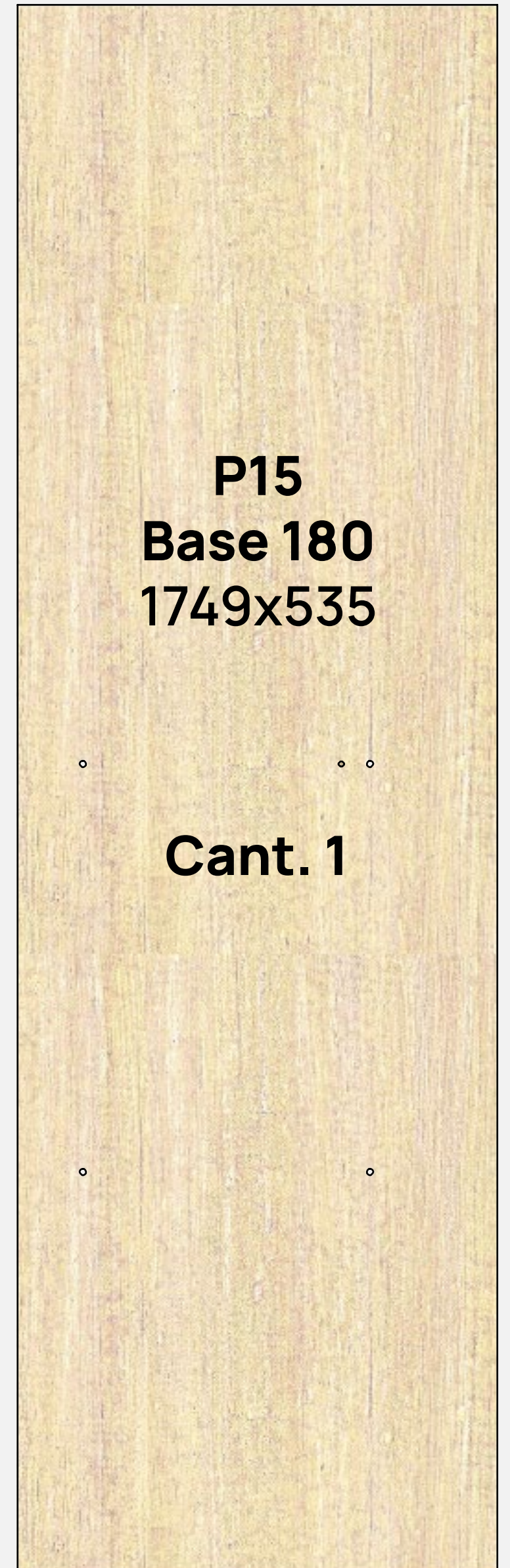
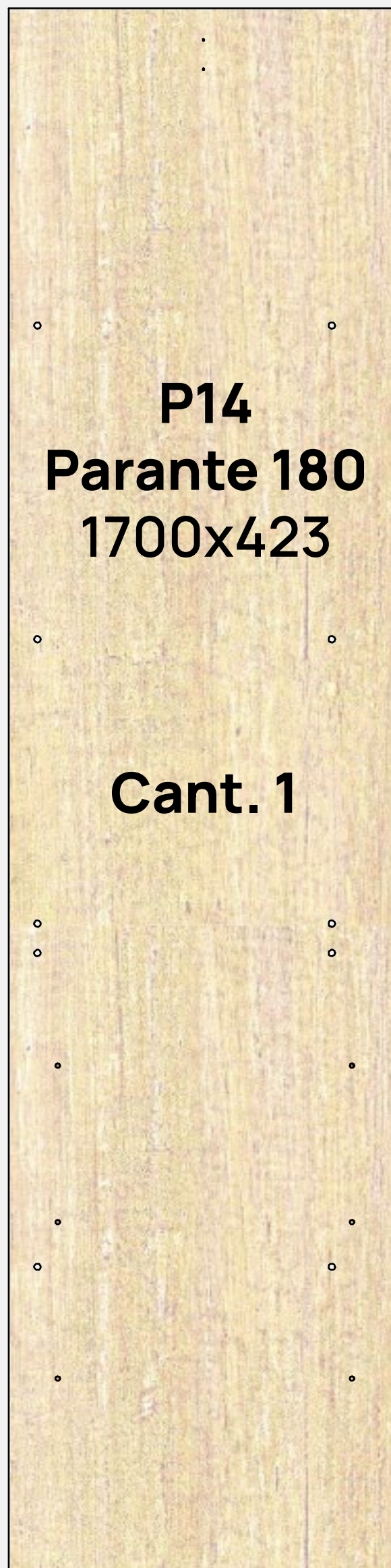
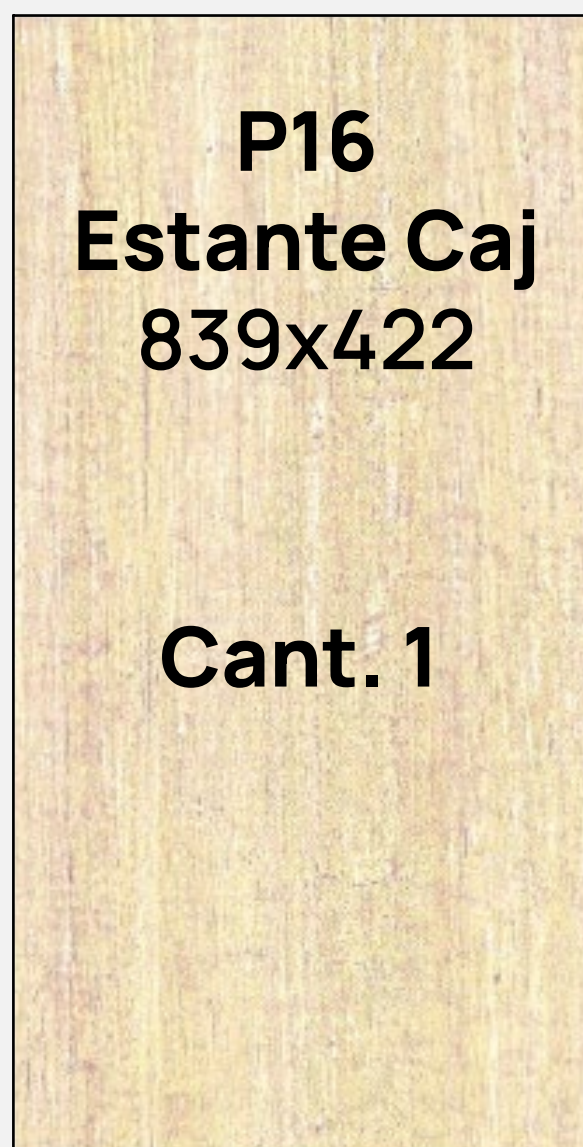
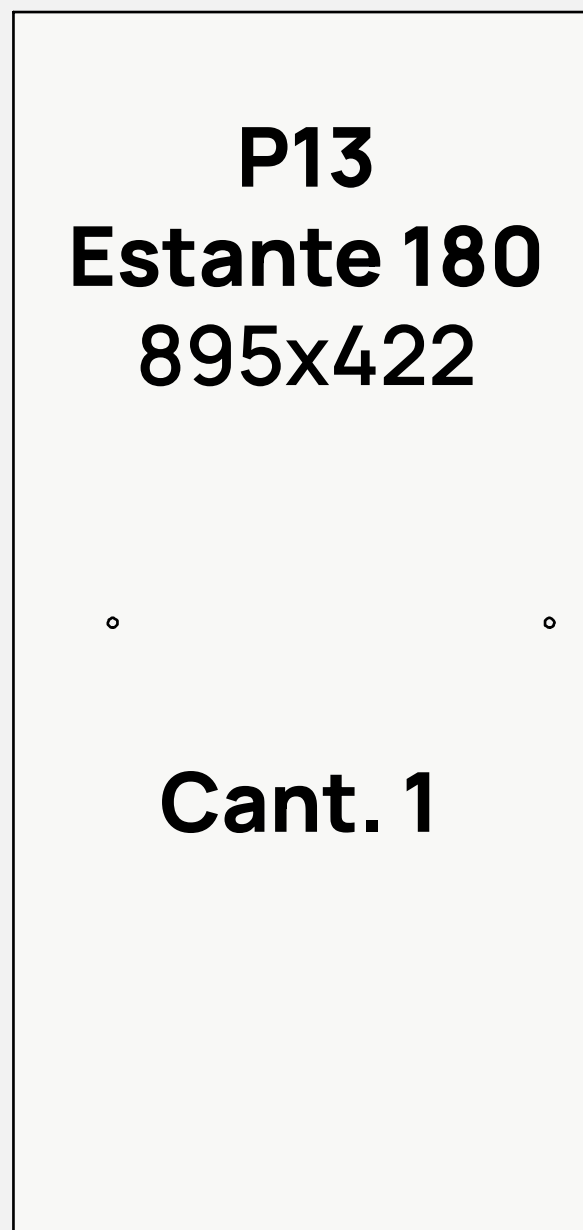
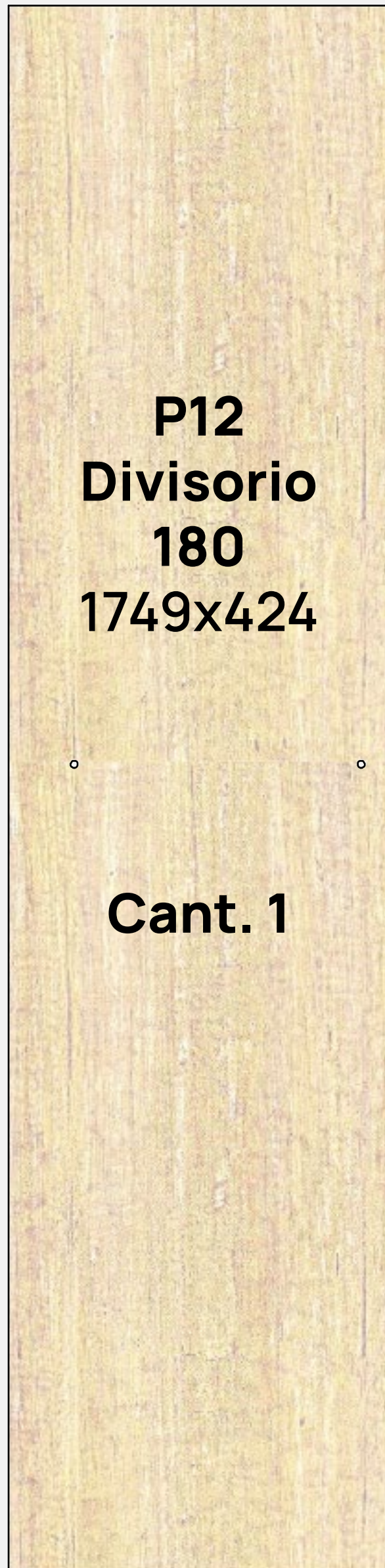

Protección caja
No se usa en armado

P18
Puntera

530x70
Cant. 2

Abrí la caja y posicioná
las piezas en el piso.

**CAJA 3
DE 3**

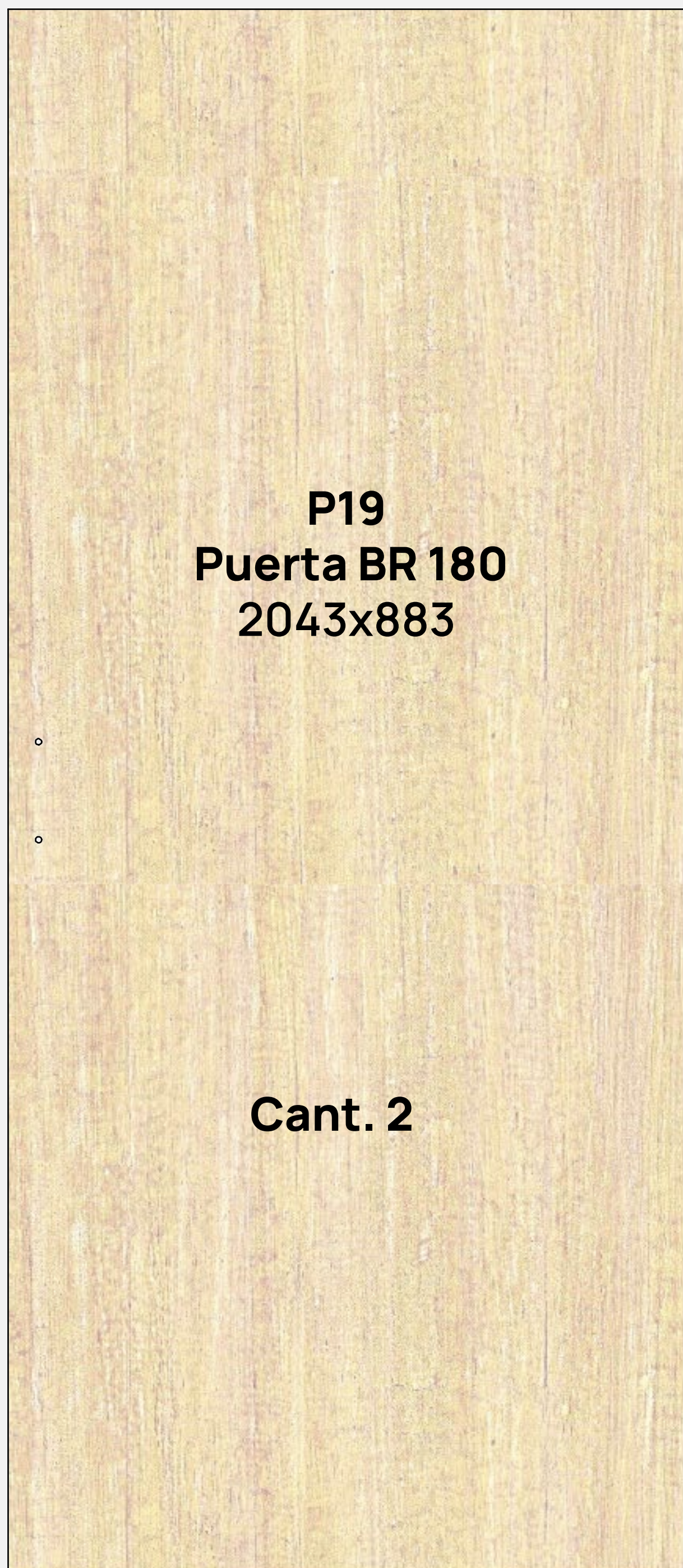

**P19
Puerta BR 180
2043x883**

Cant. 2



**P20
Fondo Inf
1718x426**

Cant. 2

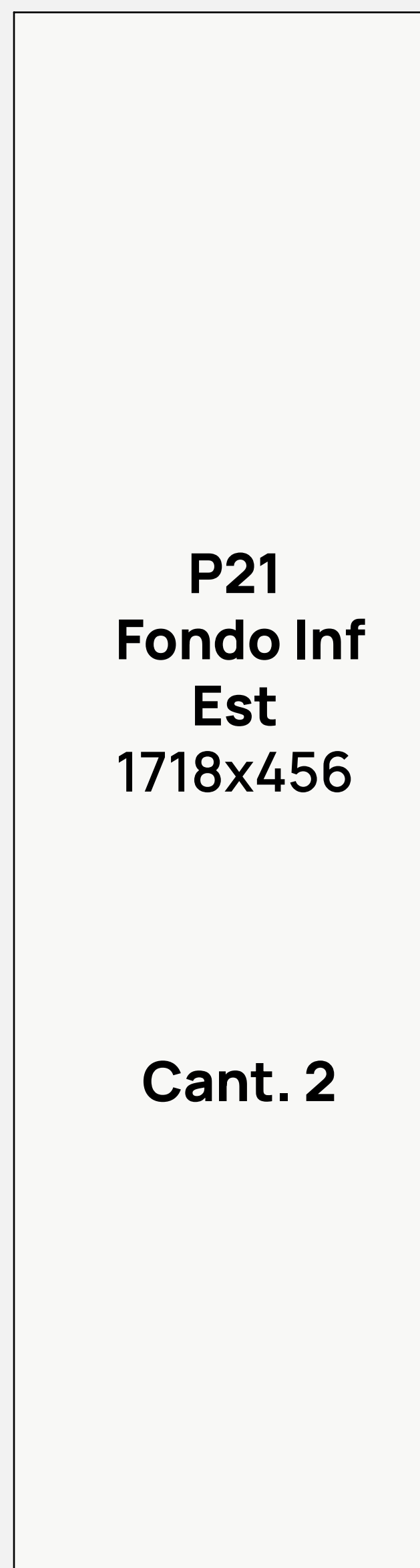

**P21
Fondo Inf
Est
1718x456**

Cant. 2



**P22 Fondo Sup 180
1769x372**

Cant. 1



P23 Cenefa 180 1749x90

Cant. 1



P24 Zócalo DEL 1749x80

Cant. 1



P25 Zócalo TRAS 1749x80

Cant. 1

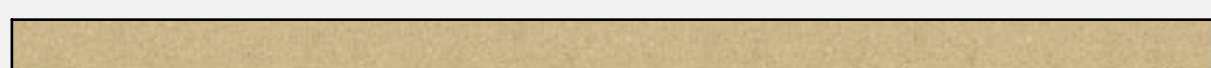

P26 Puntera

Protección caja
No se usa en armado

800x40

Cant. 2

Herrajes



H1

Tornillo
variante 6x8

12 ud.



H2

Tornillo
6.3x50 Allen

51 ud.



H3

Corredera
Z 400

3 ud.

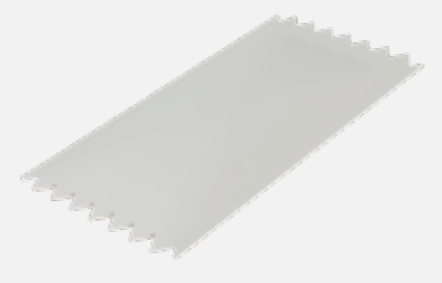

H4

Sachet de
Cola 10 grs.

1 ud.



H5

Tarugo
6x30

9 ud.



H6

Base plástica
redonda

6 ud.



H7

Clavo

1 bolsa



H8

Tornillo
3.5x15

34 ud.



H9

Escuadra
plástica

1 ud.



H10

Tarugo
8x50

2 ud.



H11

Tornillo
4x25

2 ud.



H12

Trapecio

2 ud.

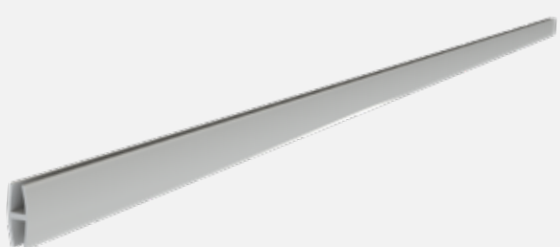

H13

Varilla H
987mm

1 ud.



H14

Cazoleta
minifix

6 ud.



H15

Perno
minifix

6 ud.



H16

Tornillo
3.5x30

20 ud.



H17

Tornillo
Autoperf.
3.6x13

7 ud.



4 ud.



2 ud.

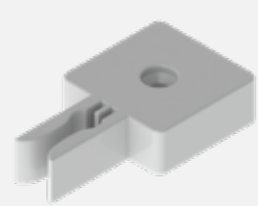

2 ud.



4 ud.

H18

Kit Rueda
+Freno

1 ud.



H19

Soporte
Lat. barral

4 ud.



H20

Marca
Empresarial

1 ud.



H21

Manija
Athena

2 ud.

¿Qué herramientas necesito?



**Para cuidar las piezas
armá el placard sobre la caja.**

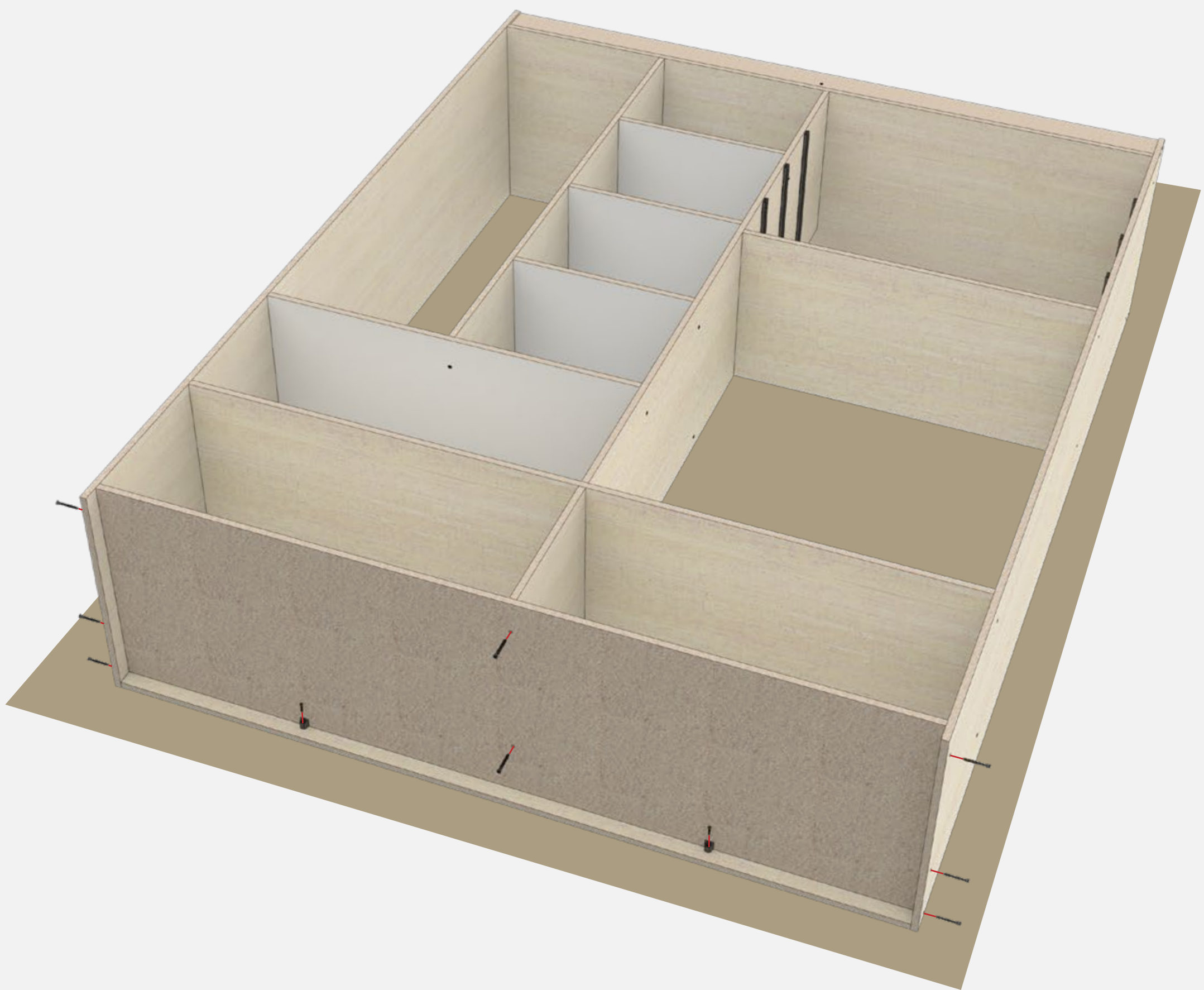

**Al momento de rotar, recomendamos
que sean dos personas.**

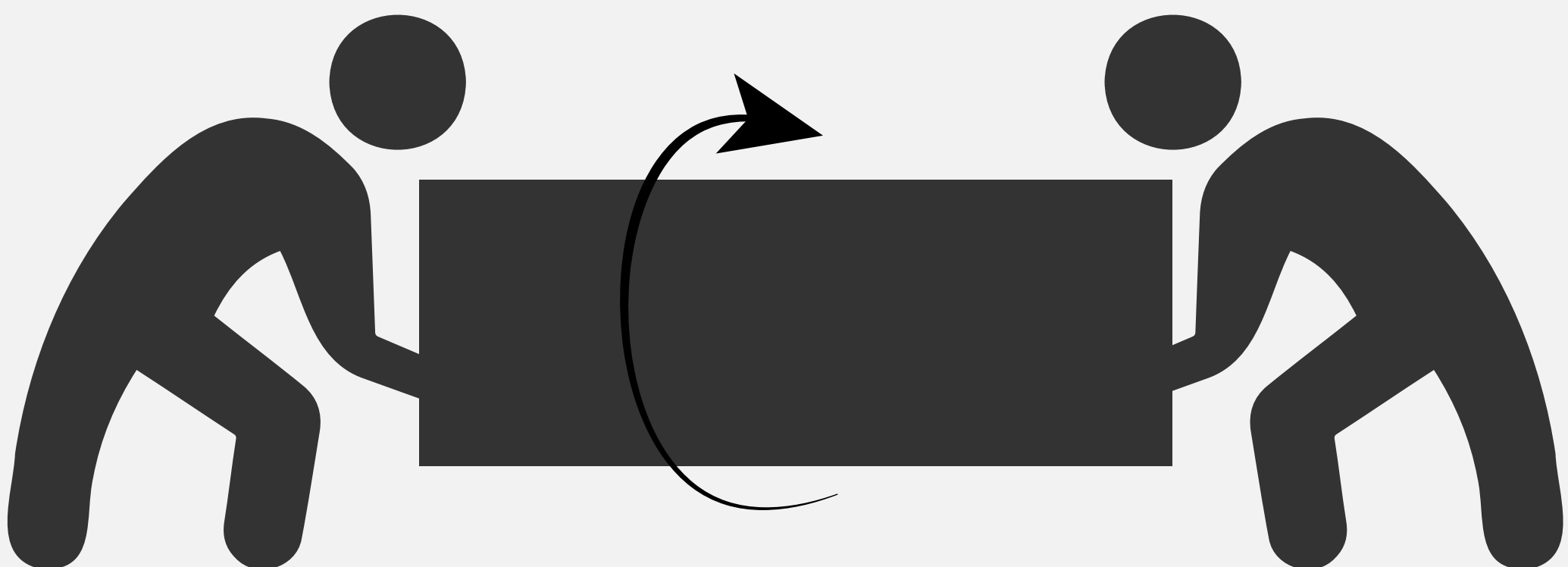

#ExperienciaMosconi
www.mosconi.com.ar

01

Colocar correderas

Vincular 3 correderas en costado derecho y 3 en parante.
Unir con 2 tornillos varianta cada una de las correderas.



P1
Costado 180 -
DER
2215x535

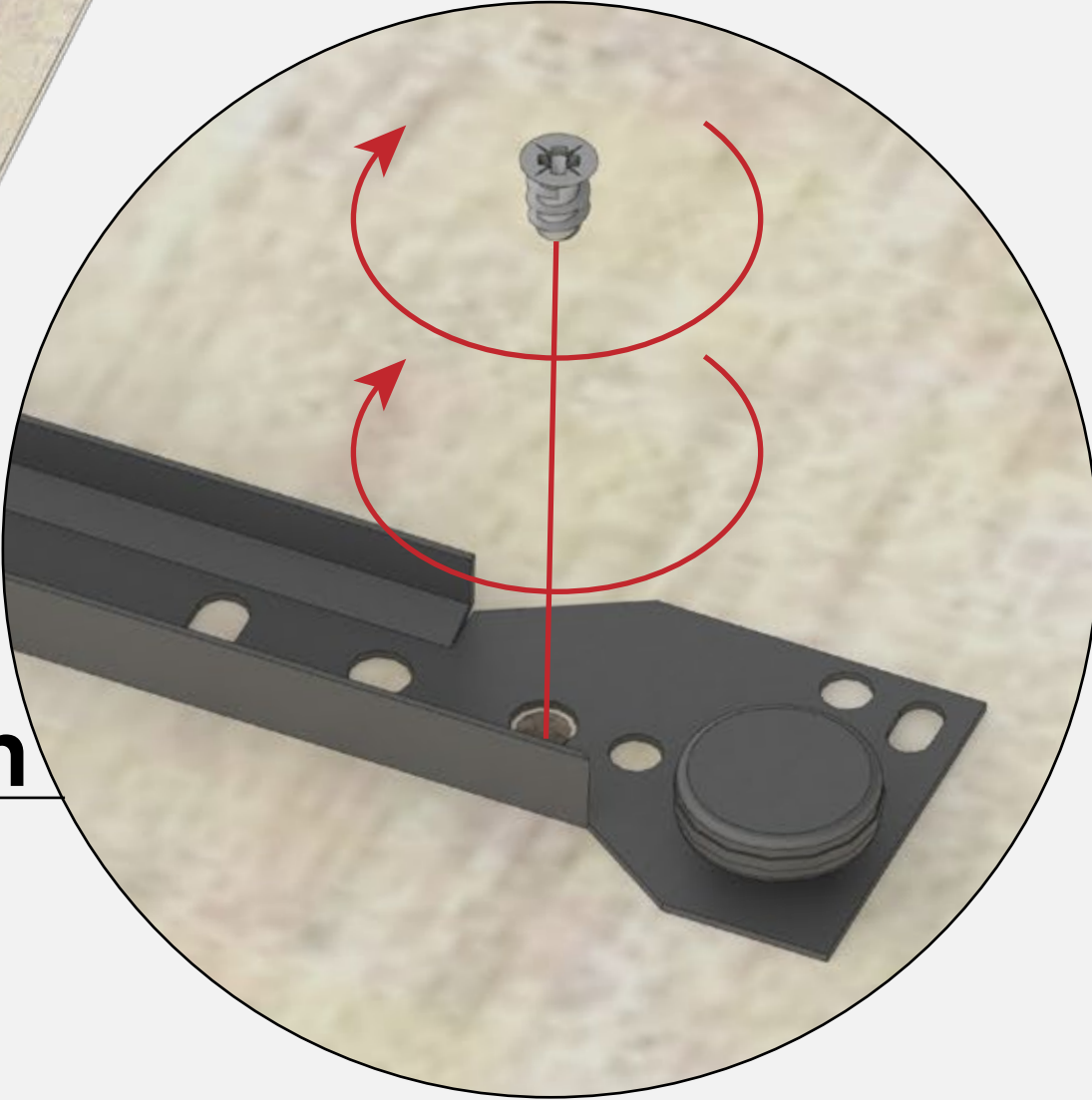
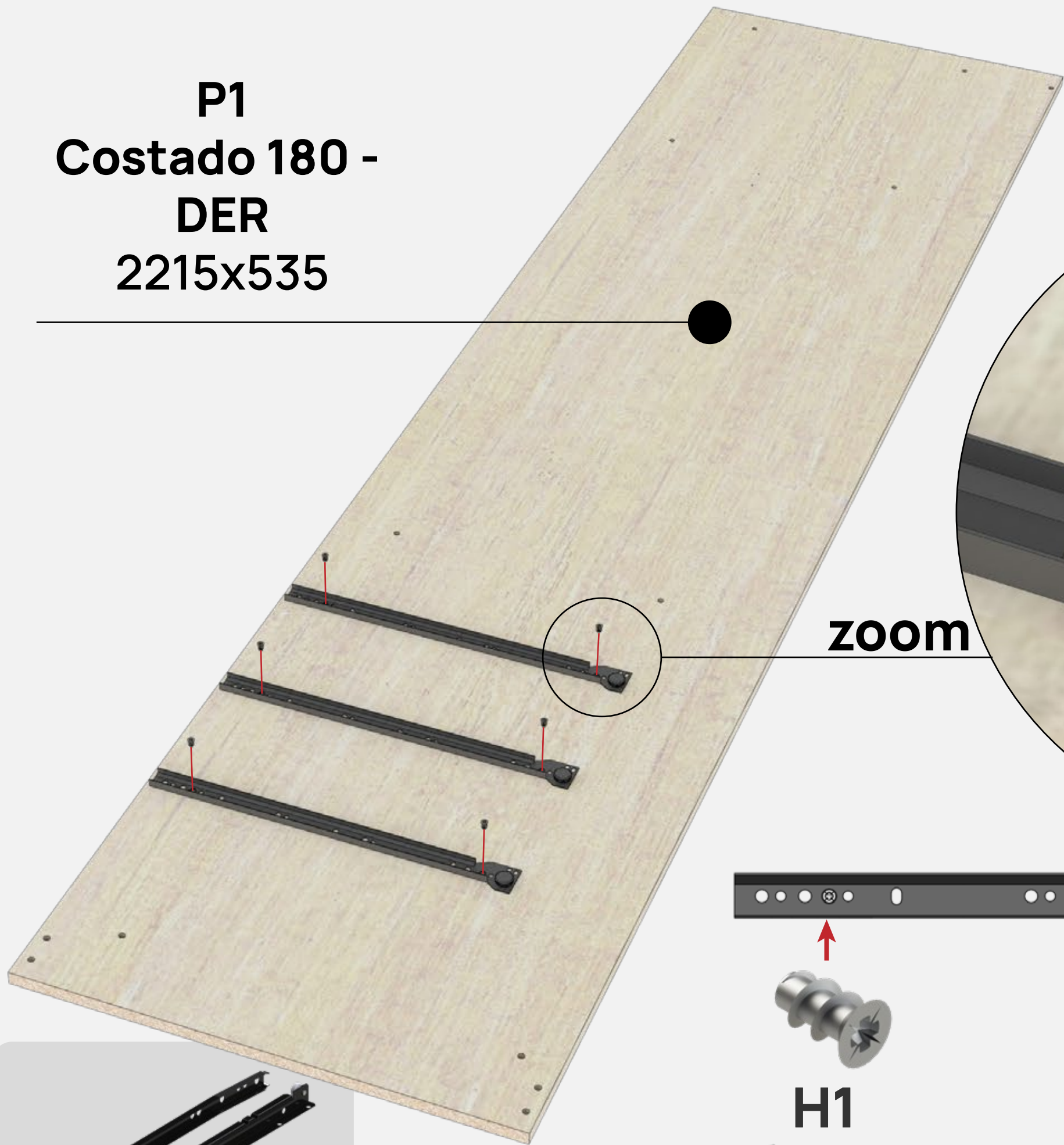

zoom



P14
Parante 180
1700x423

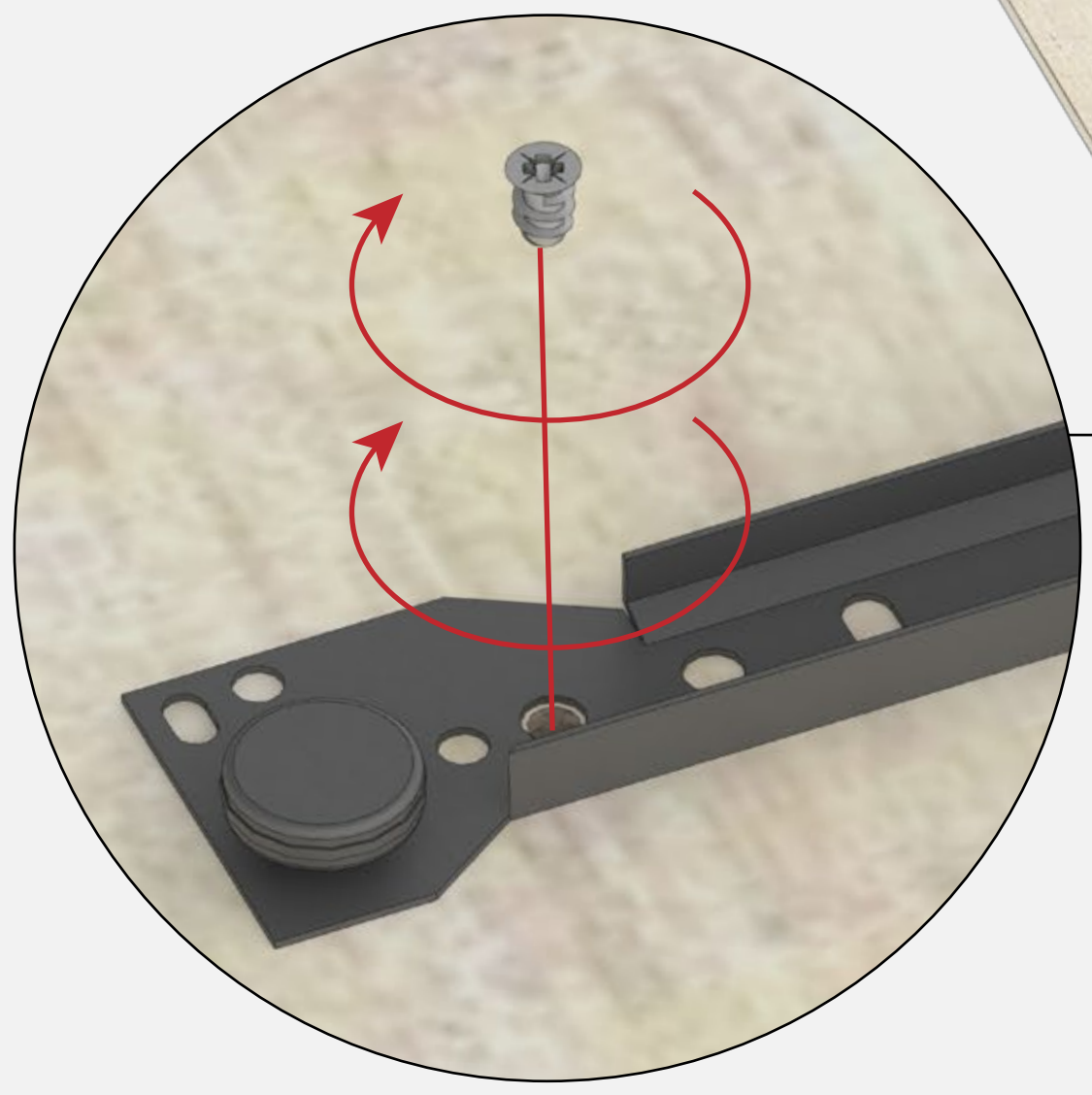
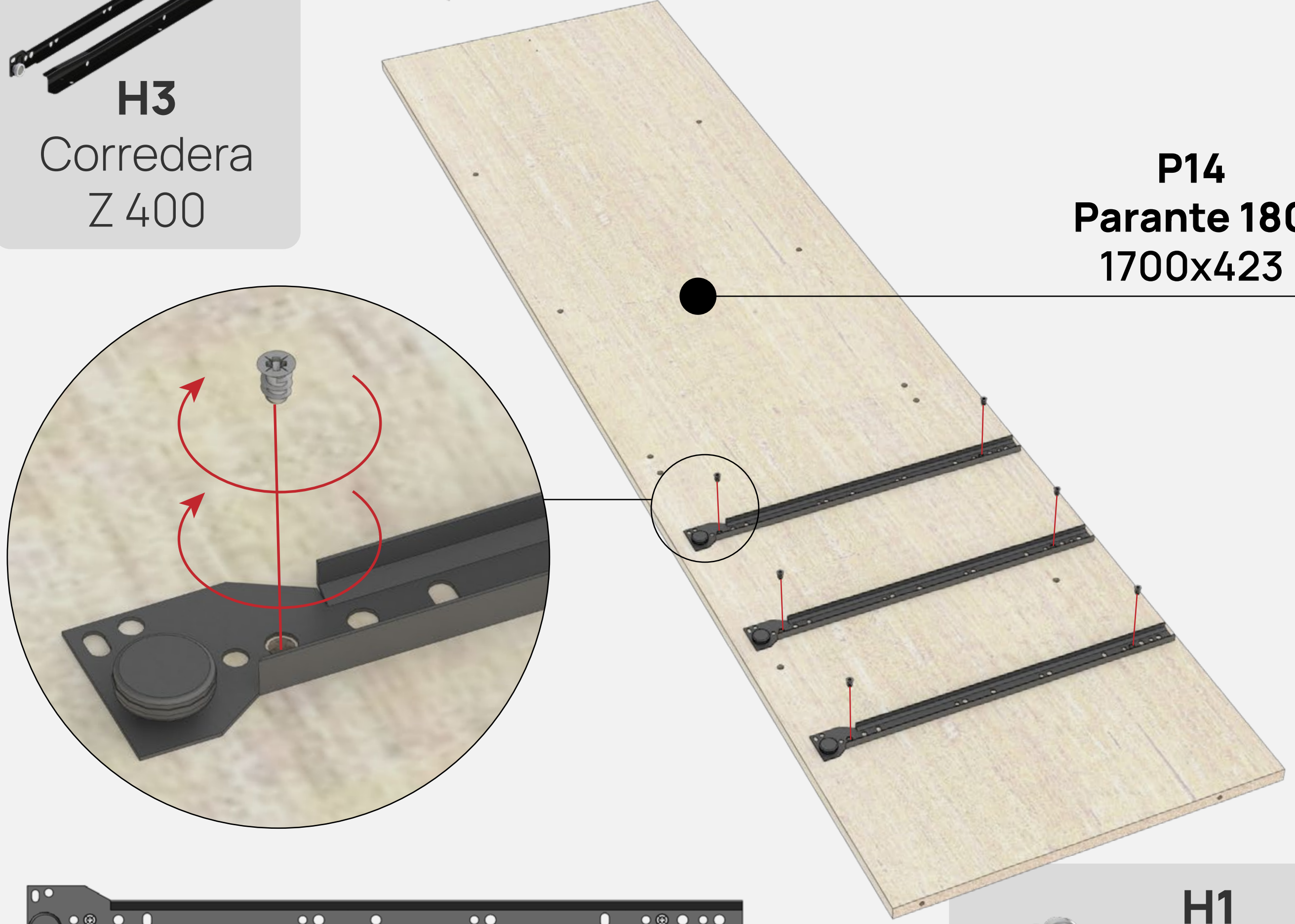

02

Armar estructura

Vincular las piezas que se ven en la imagen, utilizando 18 tornillos Allen 6.3x50.

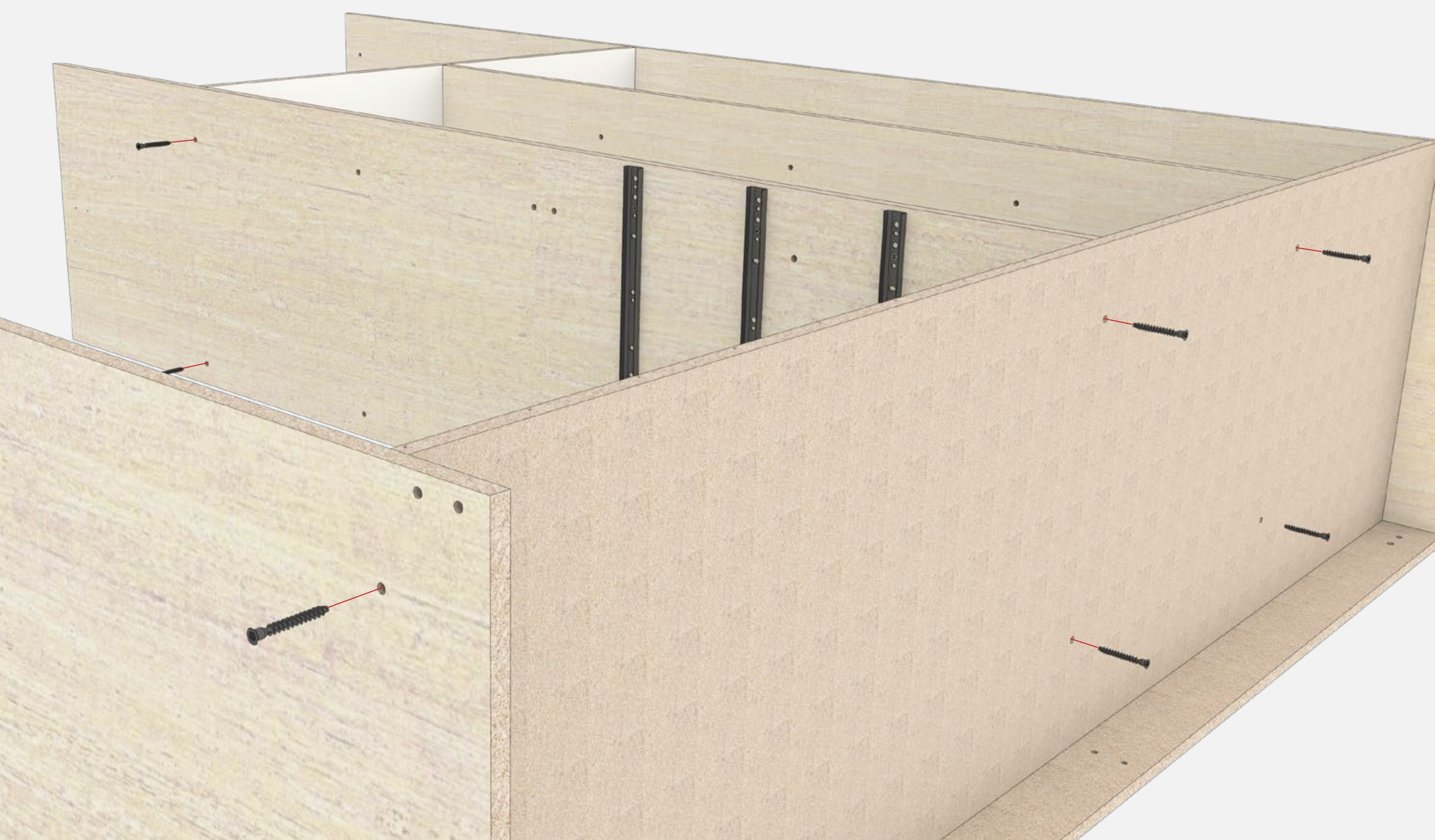
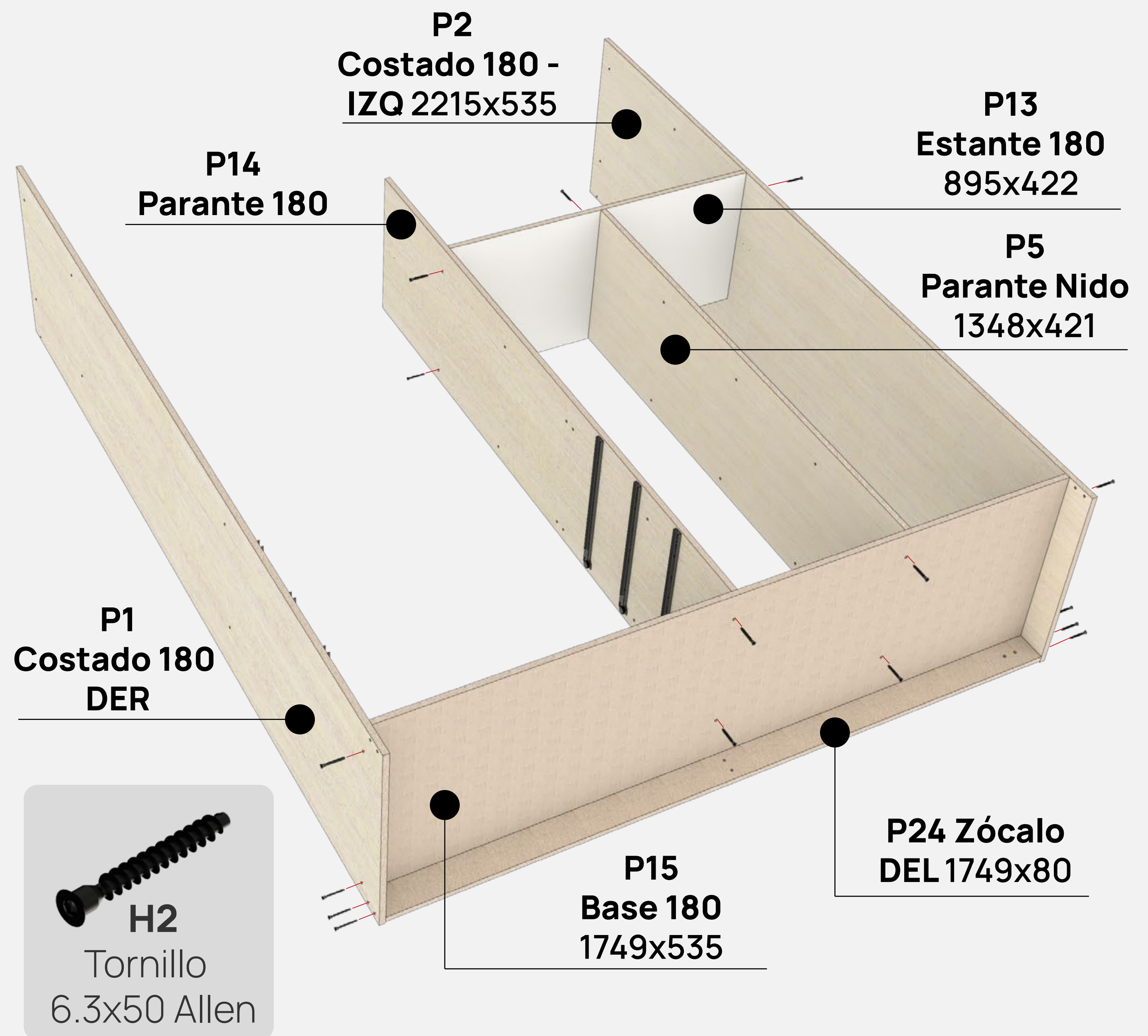
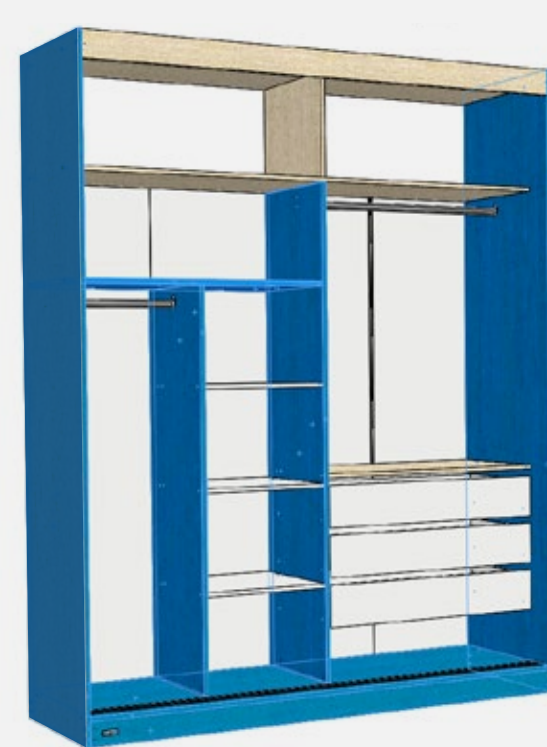

03

Colocar zócalo

Colocar zócalo central y luego vincular zócalo trasero.

Encolá las perforaciones antes de colocar tarugos.

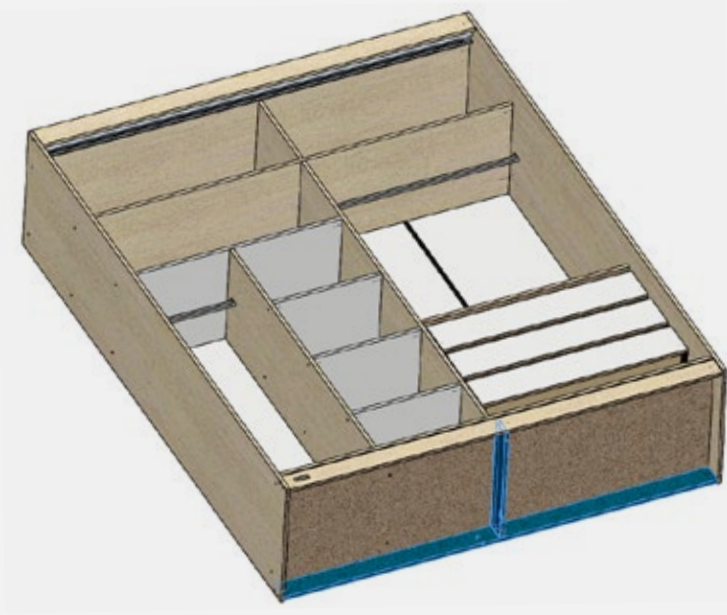

P10
Zocalo Central
495x80

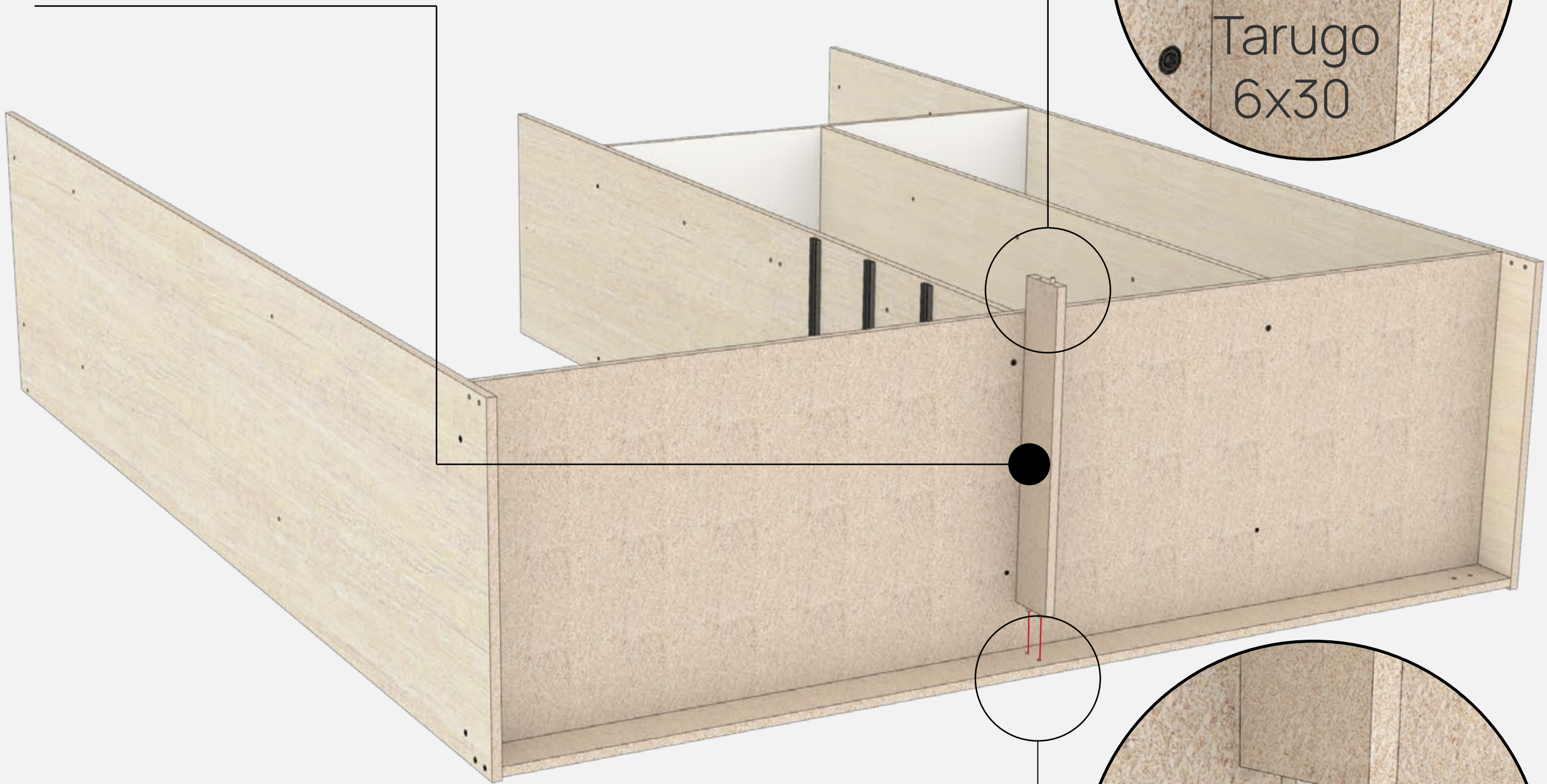

H5
Tarugo
6x30

P14
Parante 180

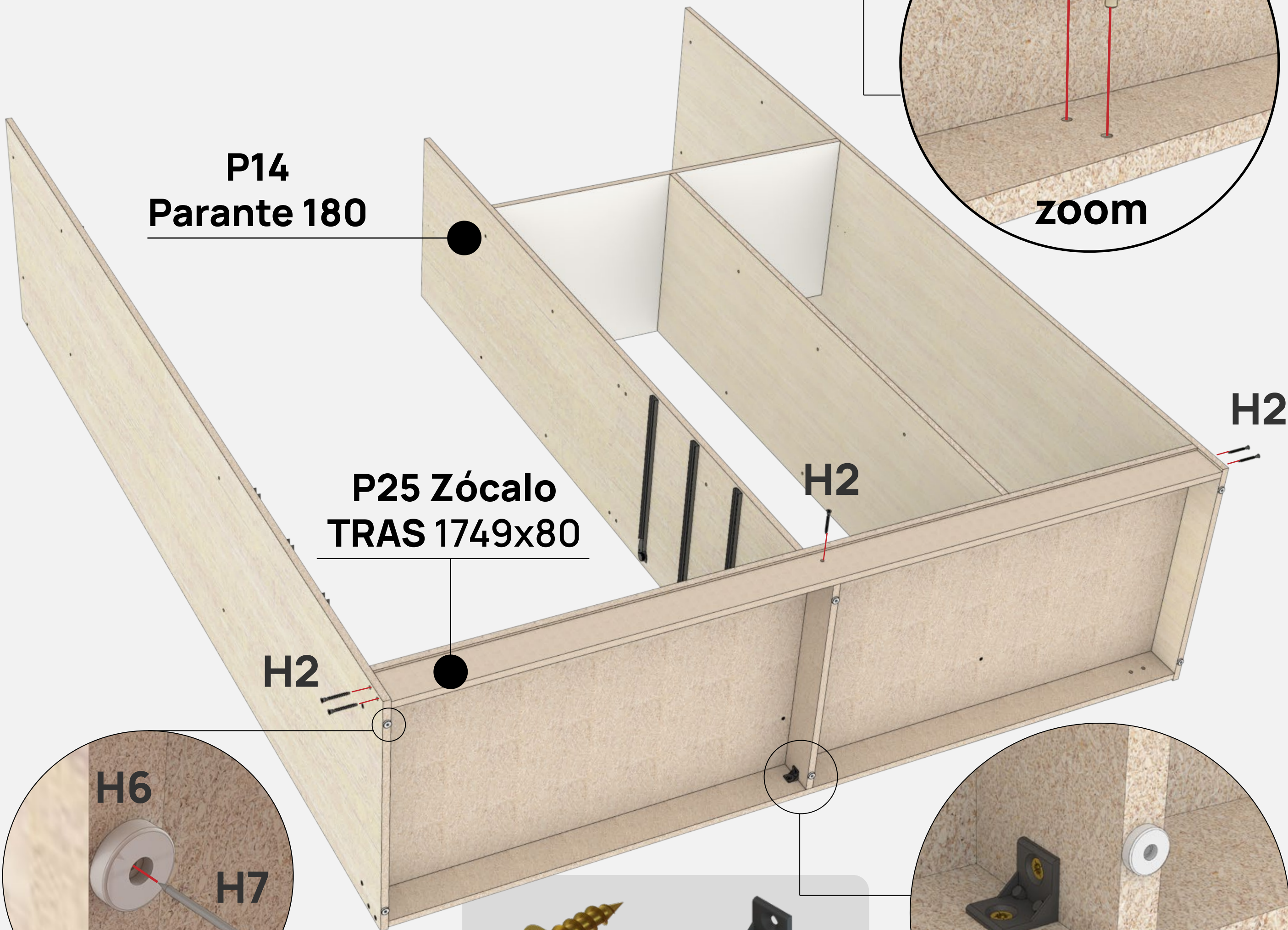

zoom

P25 Zócalo
TRAS 1749x80

H2

H2

H2

H6

H7

Colocar 6 bases
plásticas



H8

Tornillo
3.5x15



H9

Escuadra
plástica

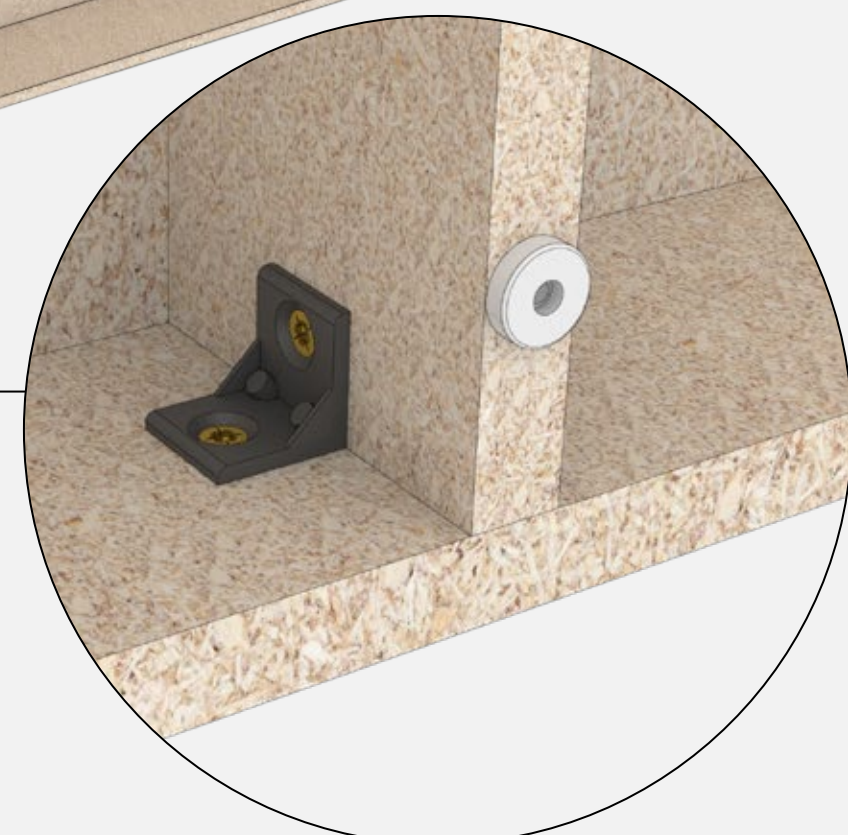

04

Colocar divisorios

Colocar Divisorio, Estantes y Parante Corto.

Encolar perforaciones donde se alojan los tarugos.

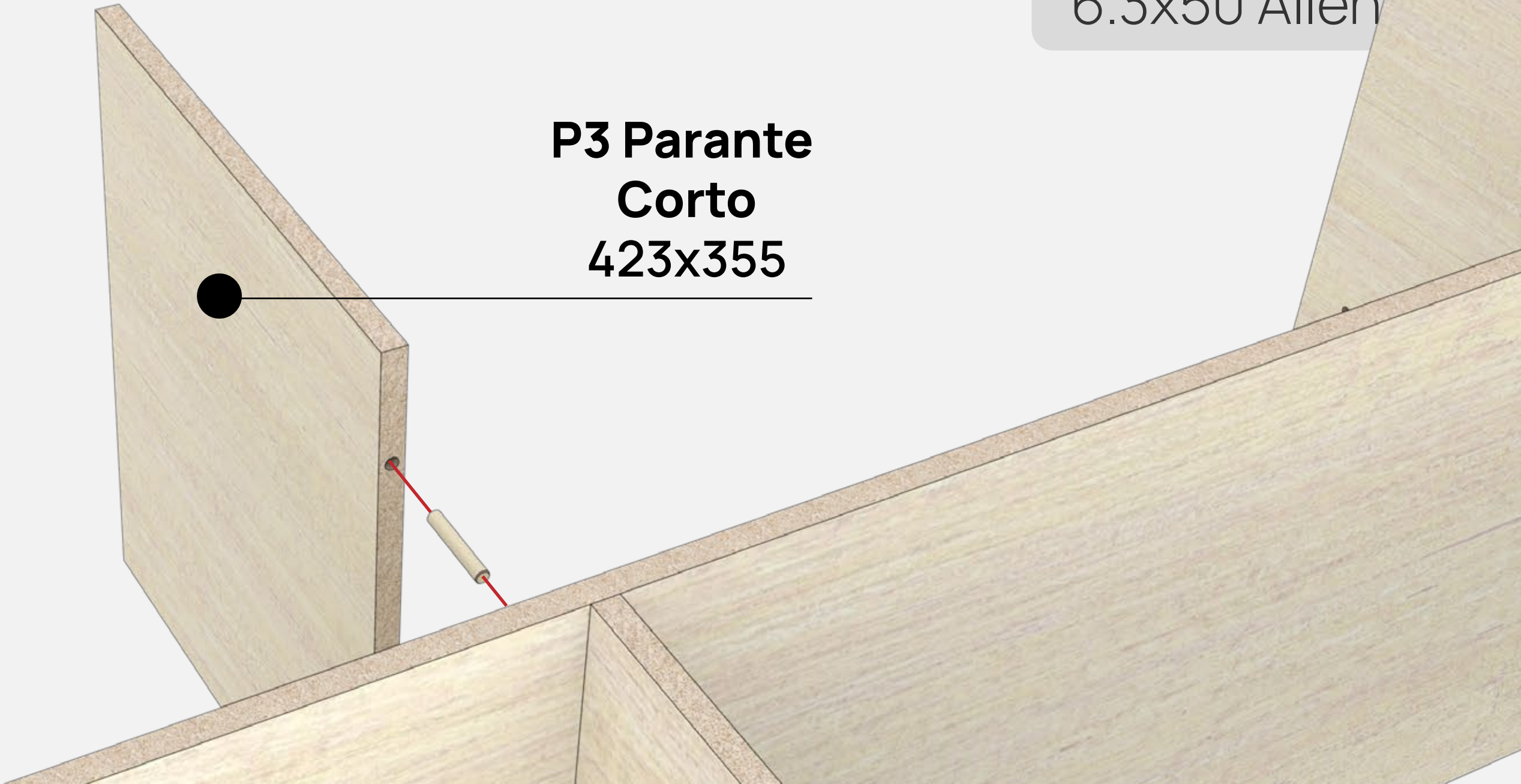
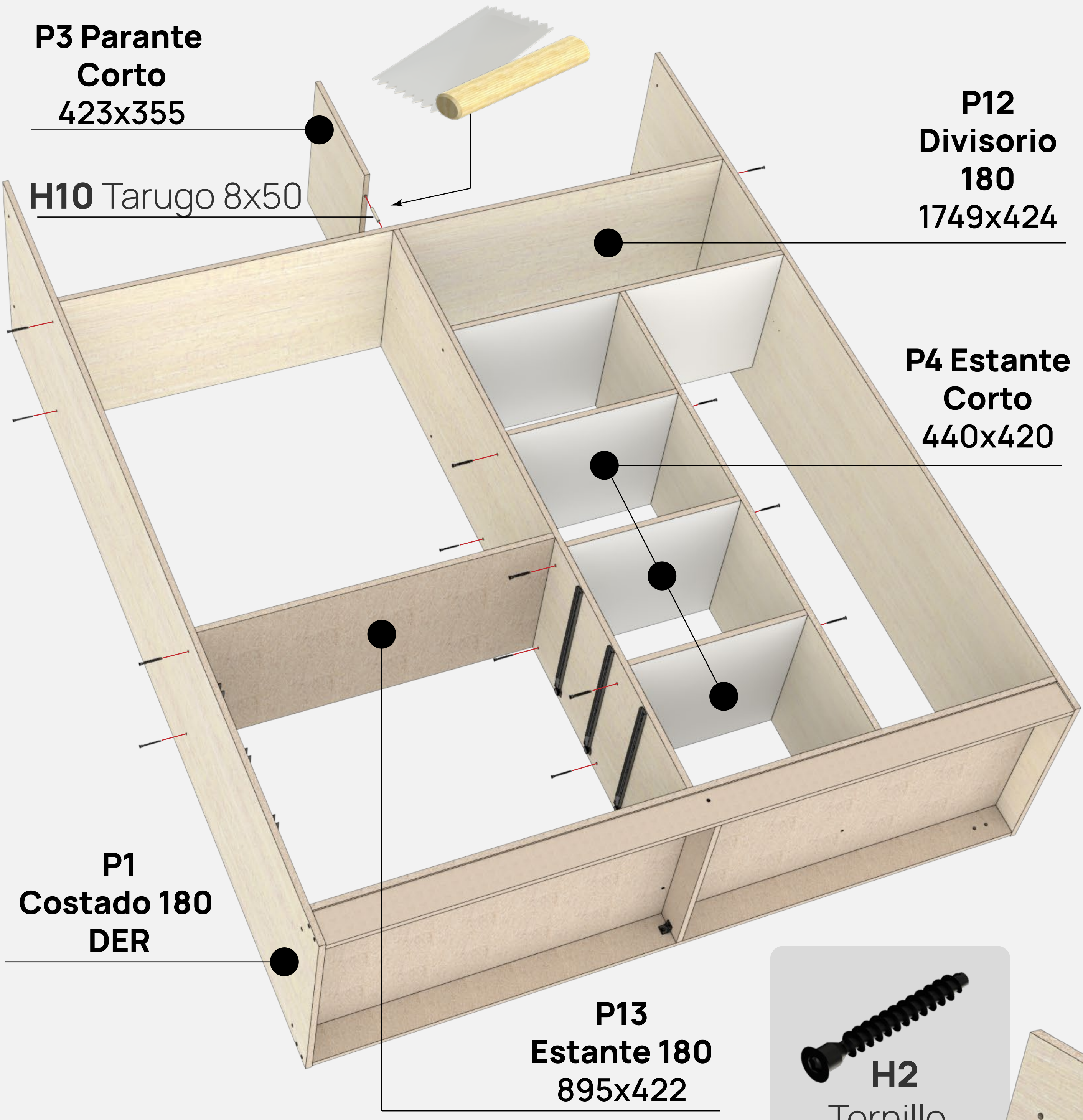

05

Colocar Techo y Cenefa

Vincular techo con 4 tornillos Allen, luego vincular cenefa con 2 tornillos Allen y 2 trapecios.



H2

Tornillo
6.3x50 Allen

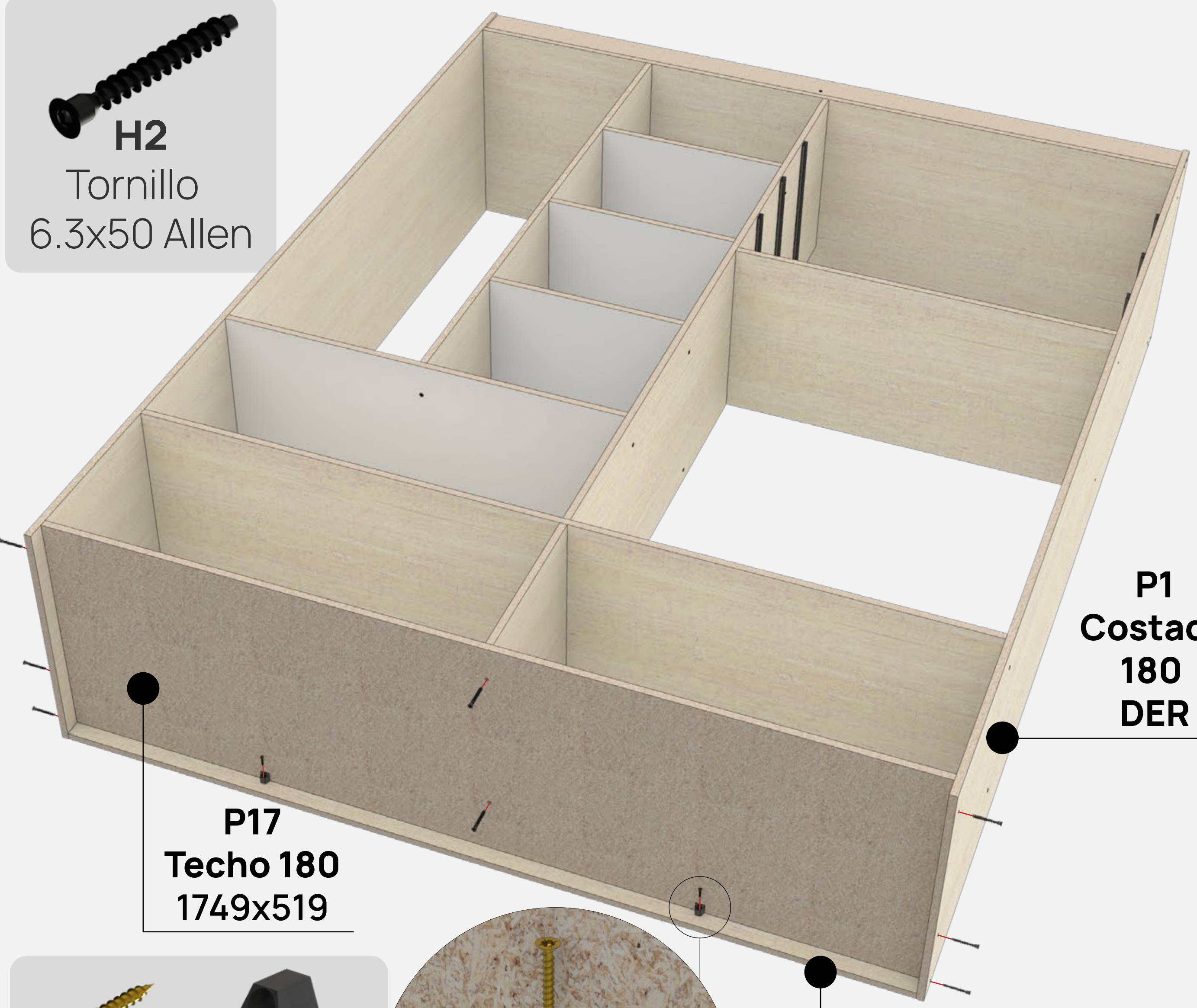

P17
Techo 180
1749x519

P1
Costado
180
DER



H11

Tornillo
4x25



H12

Trapezio

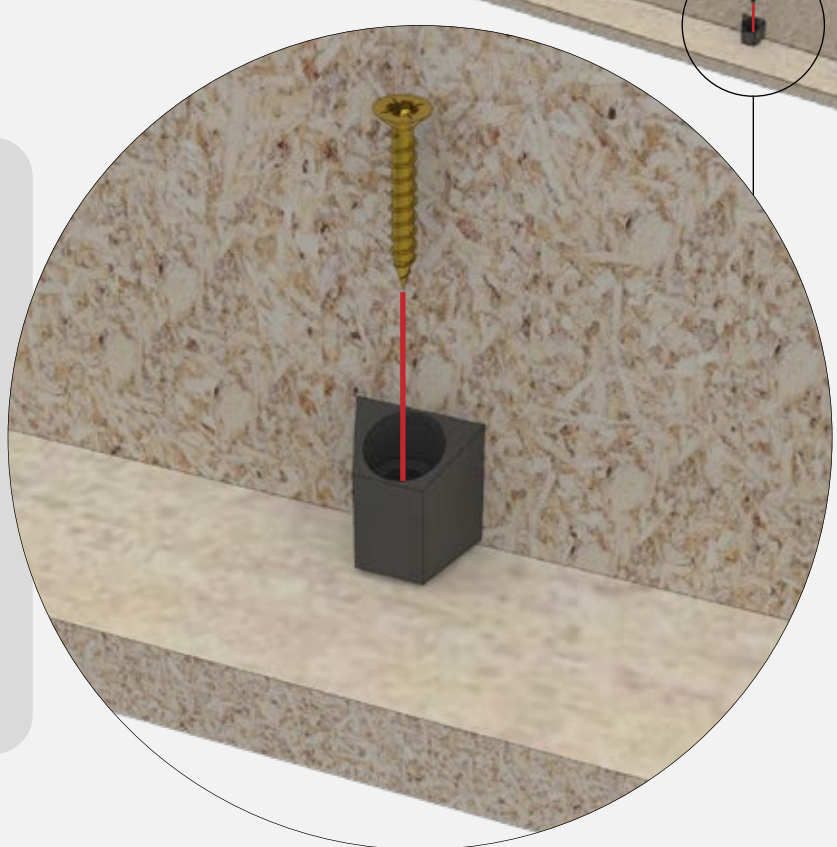

P23 Cenefa 180
1749x90



H2

Tornillo
6.3x50 Allen

06

Clavar fondo

Corroborar que el mueble esté colocado en escuadra a 90° y clavar 5 fondos. Clavos cada 13 cm aprox.

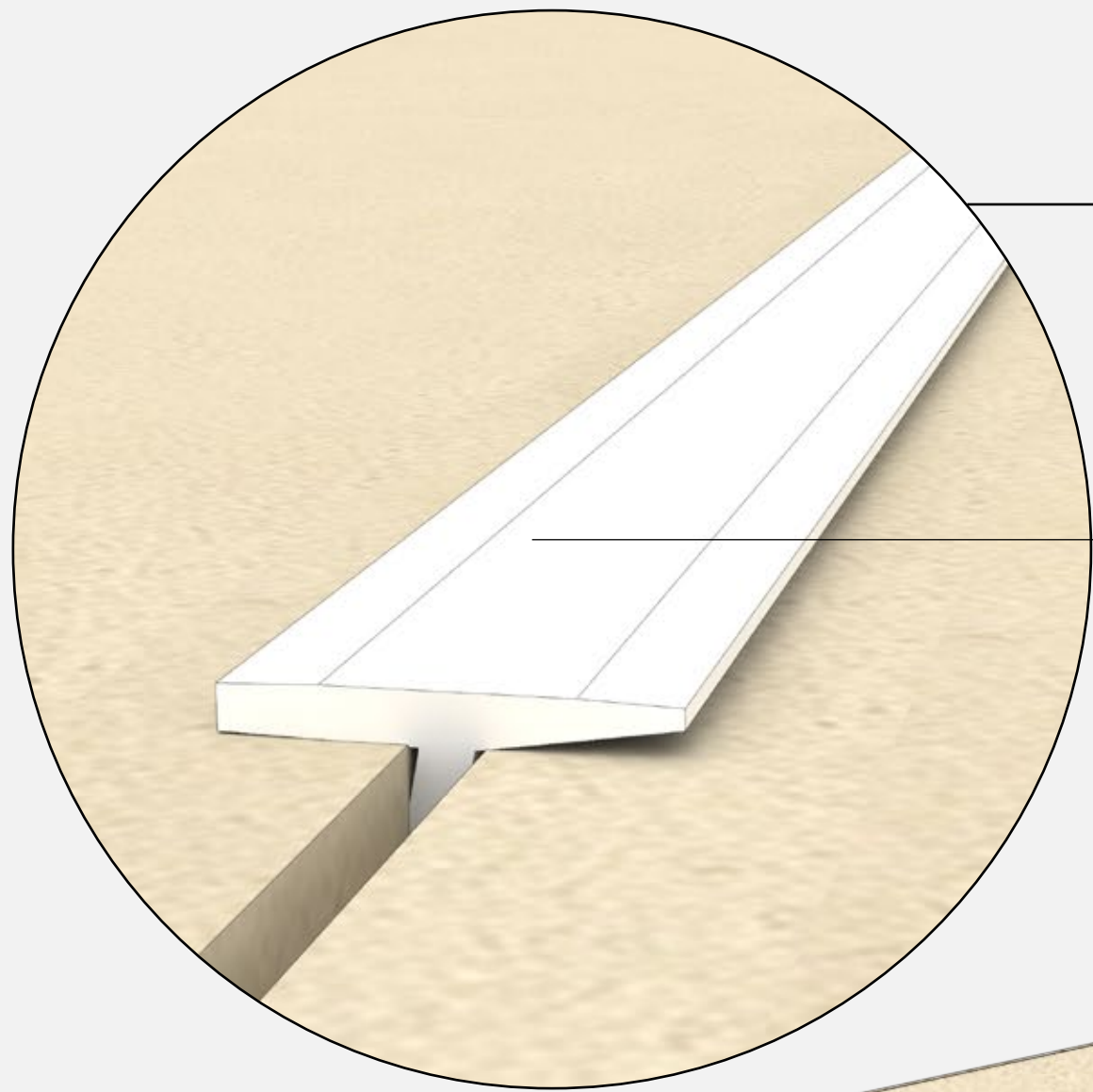
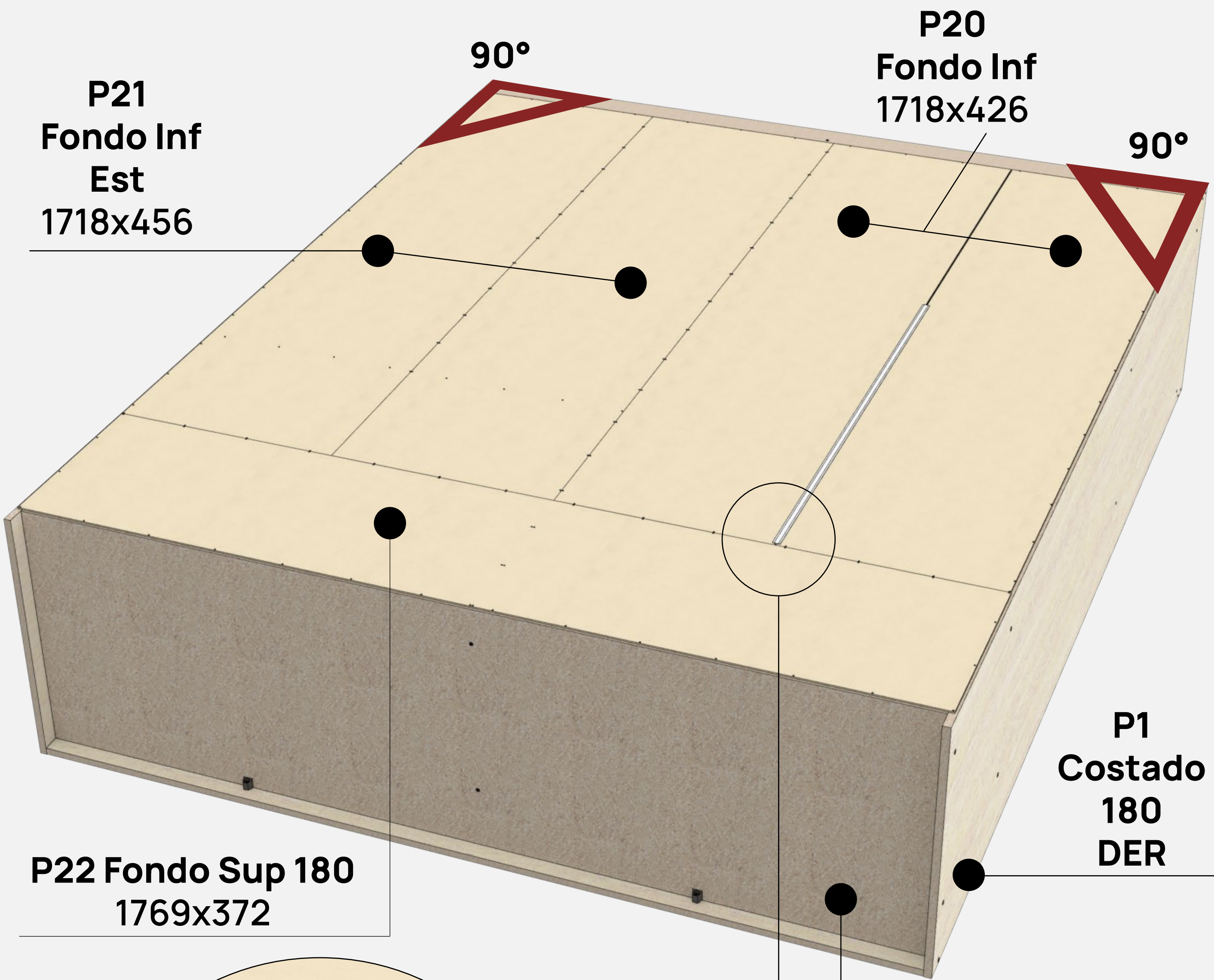
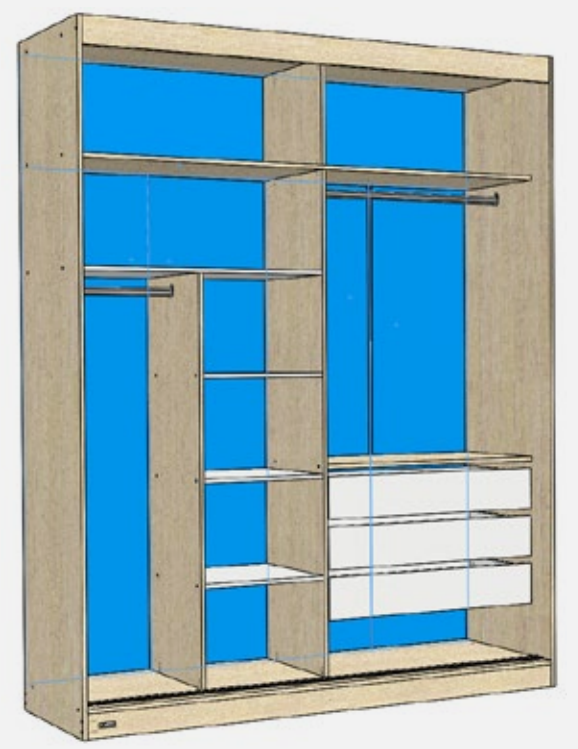

H13
Varilla H

P17
Techo 180
1749x519

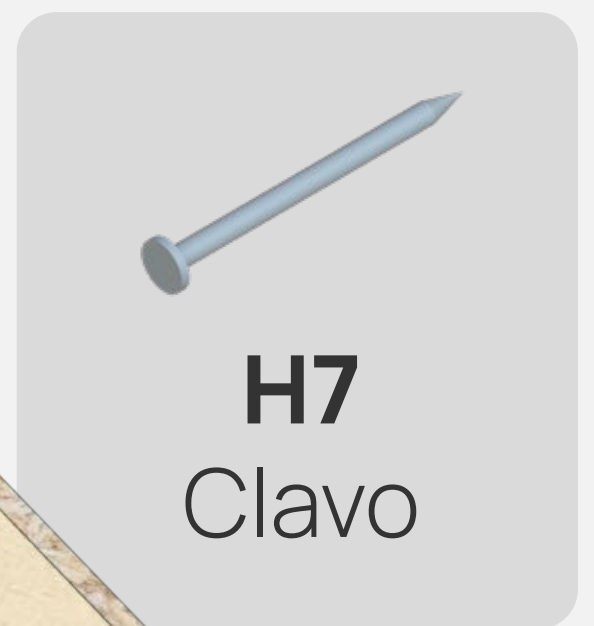
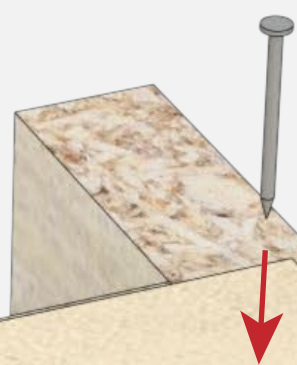

H7
Clavo

07

Costado de cajón

Colocar a presión **cazoletas**,
y **tarugos**.

Encolar perforaciones antes
de colocar tarugos.

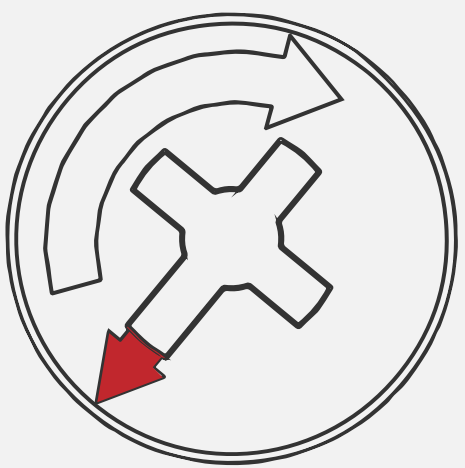
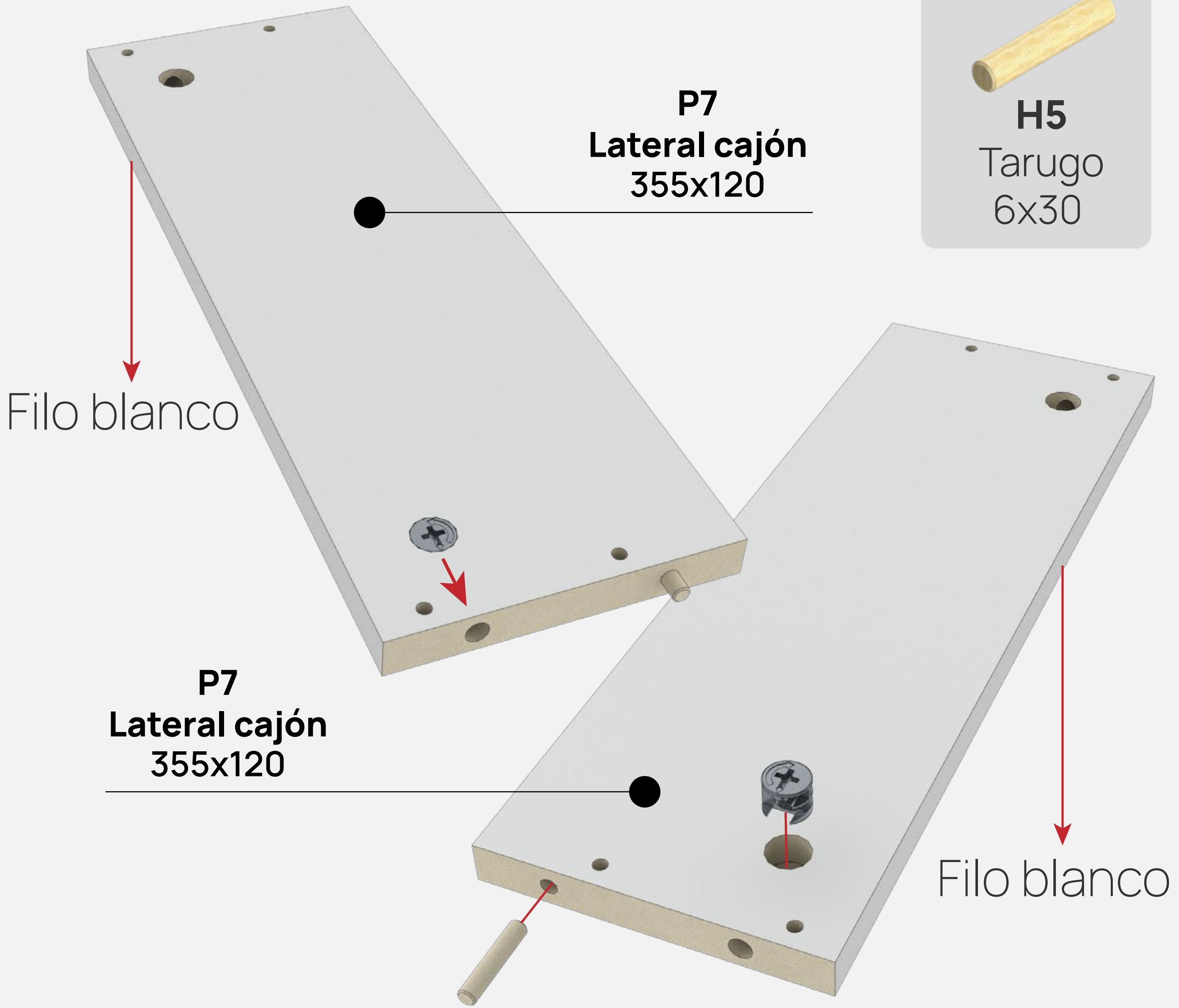
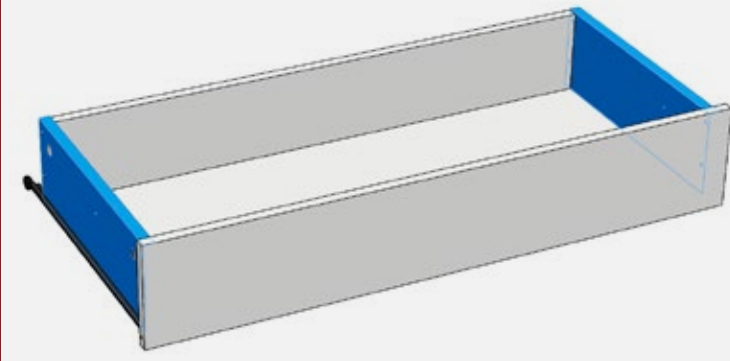

Colocar **cazoleta minifix** con la flecha
apuntando hacia la perforación.

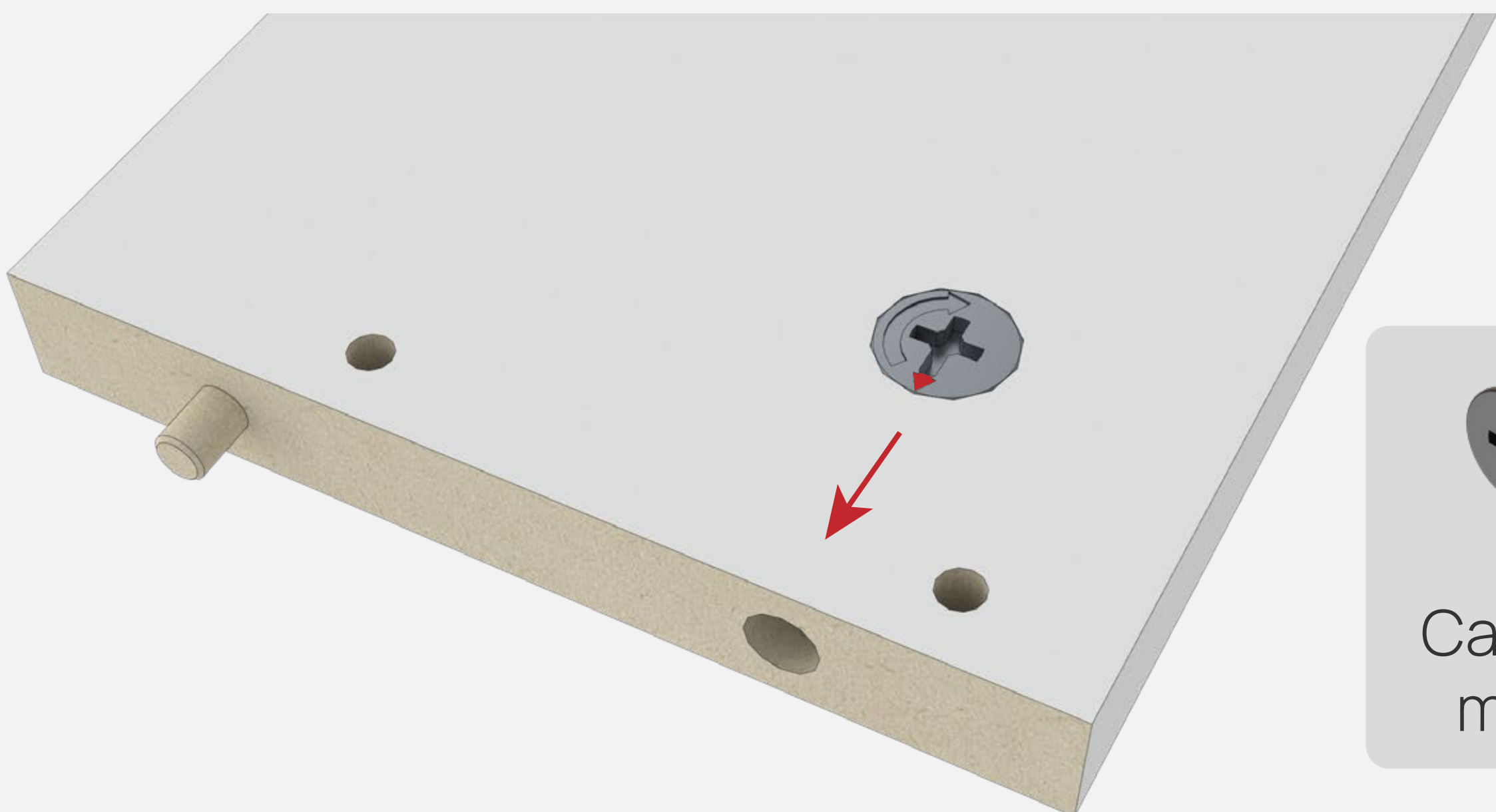

H14
Cazoleta
minifix

08

Frentes de cajones

Enroscar 2 pernos minifix,
hasta que hagan tope!

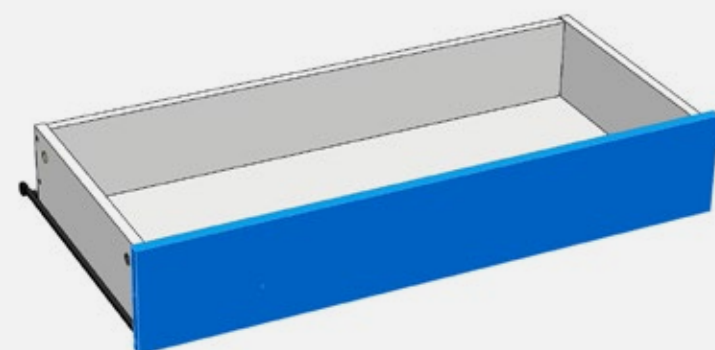

P8
Frente cajón

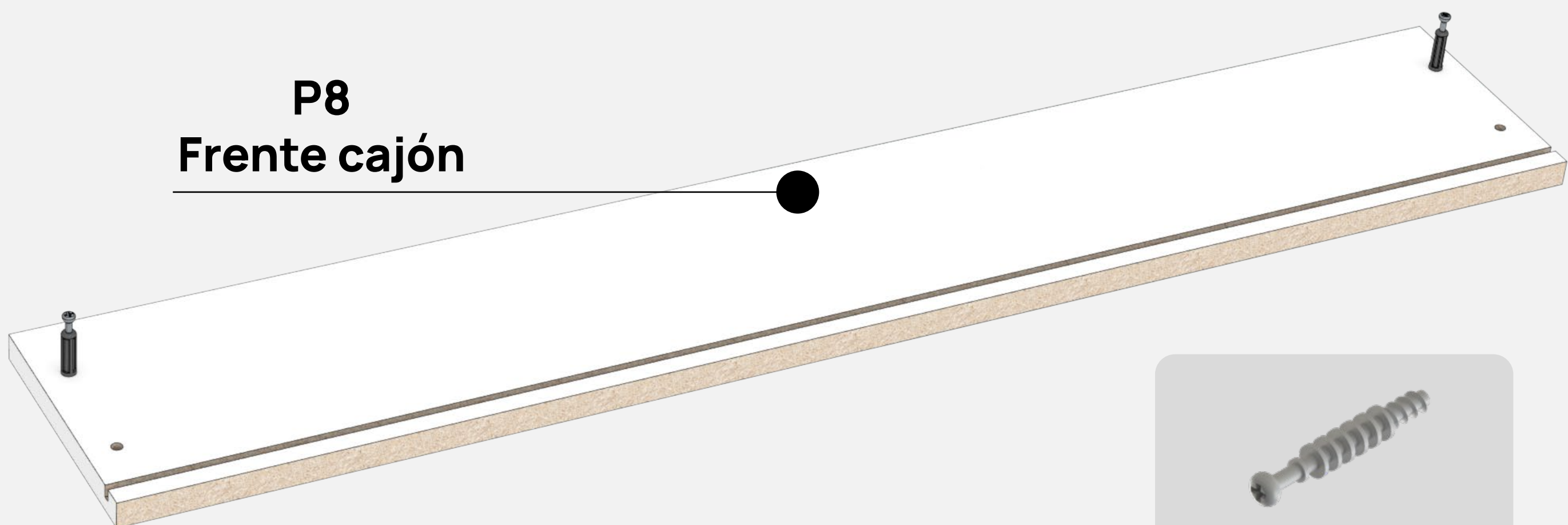

H15
Perno
minifix



Ajustar hasta
que haga **tope!**

09

Armar cajones

Unir laterales de cajón con frente y contrafrente.
Mantener cajón escuadrado a 90°.

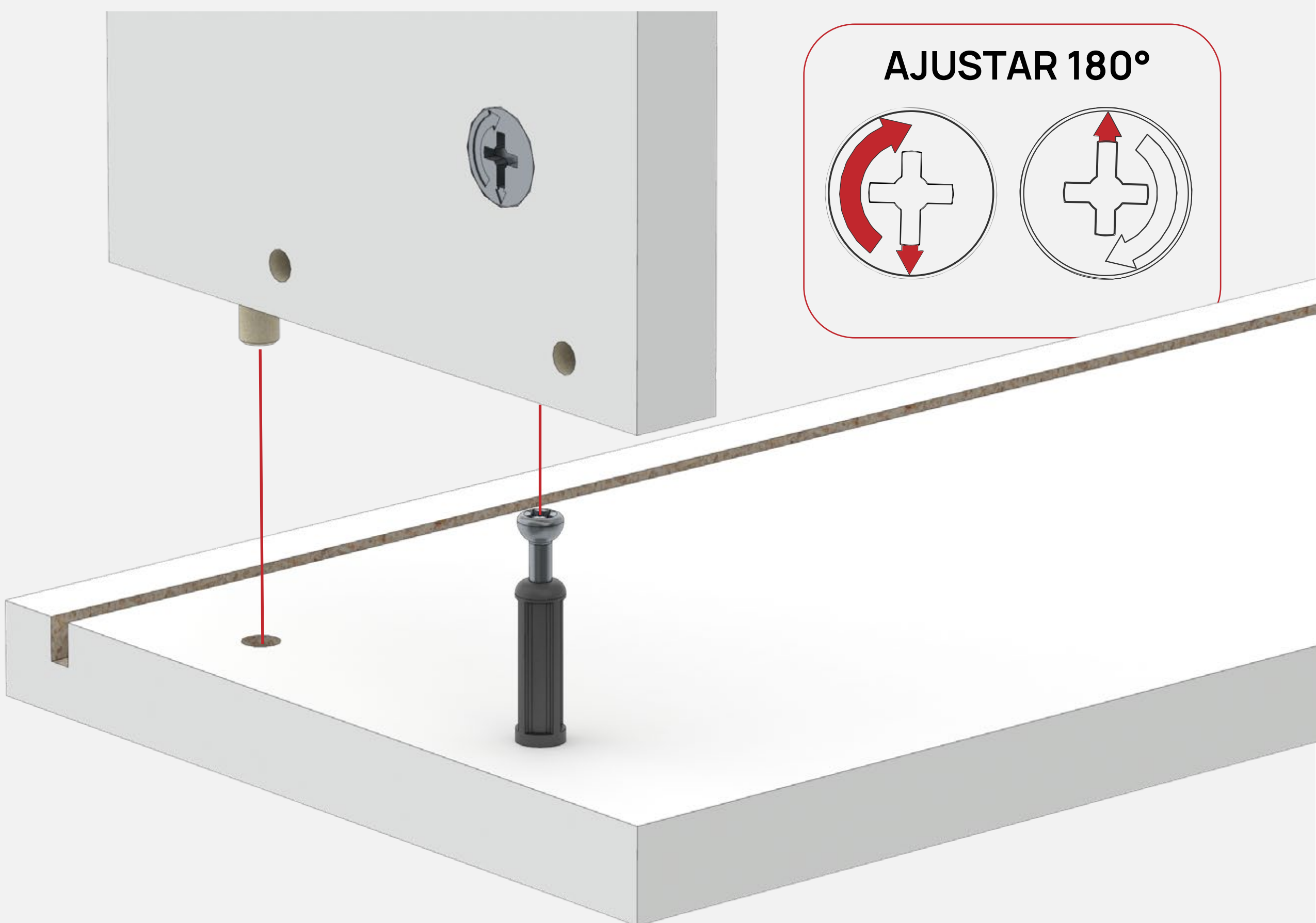
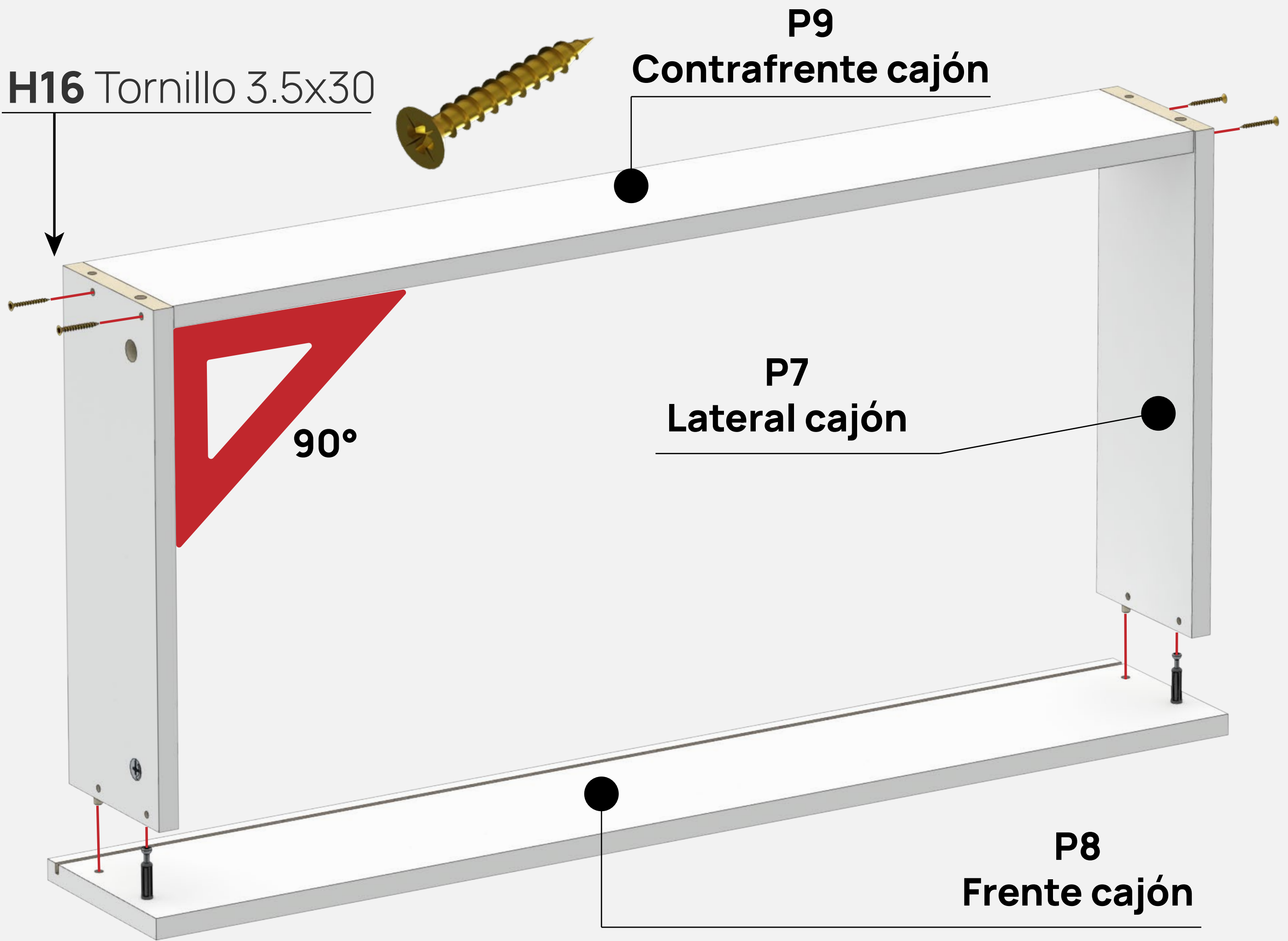

10

Colocar fondo de cajón

Clavar fondo de cajón. Es muy importante verificar escuadra a 90°. Clavos cada 12 cm. aprox

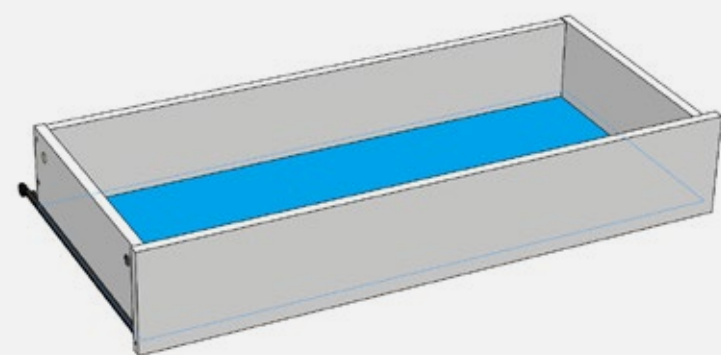

P6
Fondo
Cajón
813x362

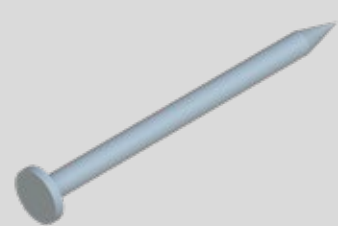
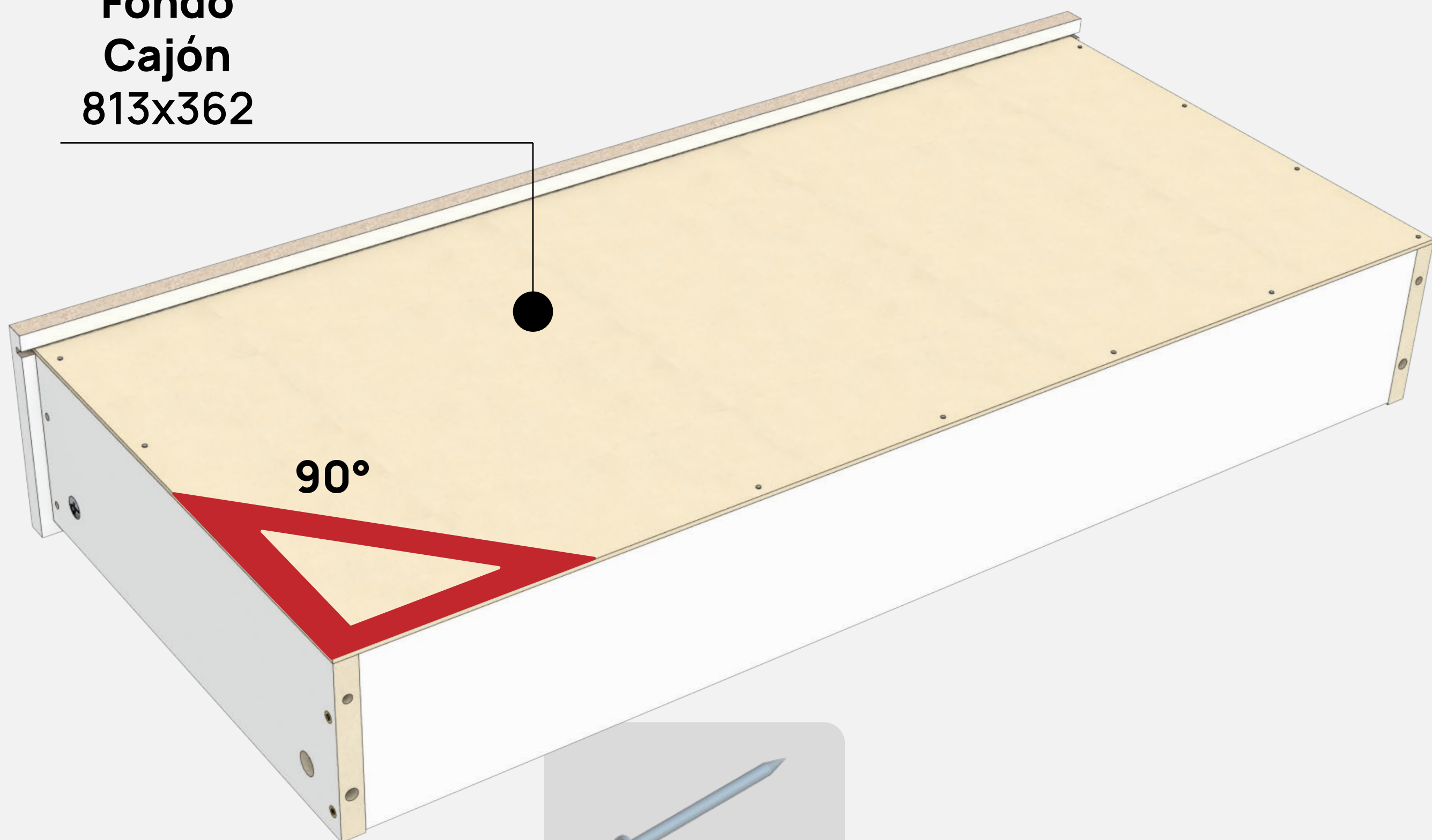

H7
Clavo

ENCASTRAR EN RANURA

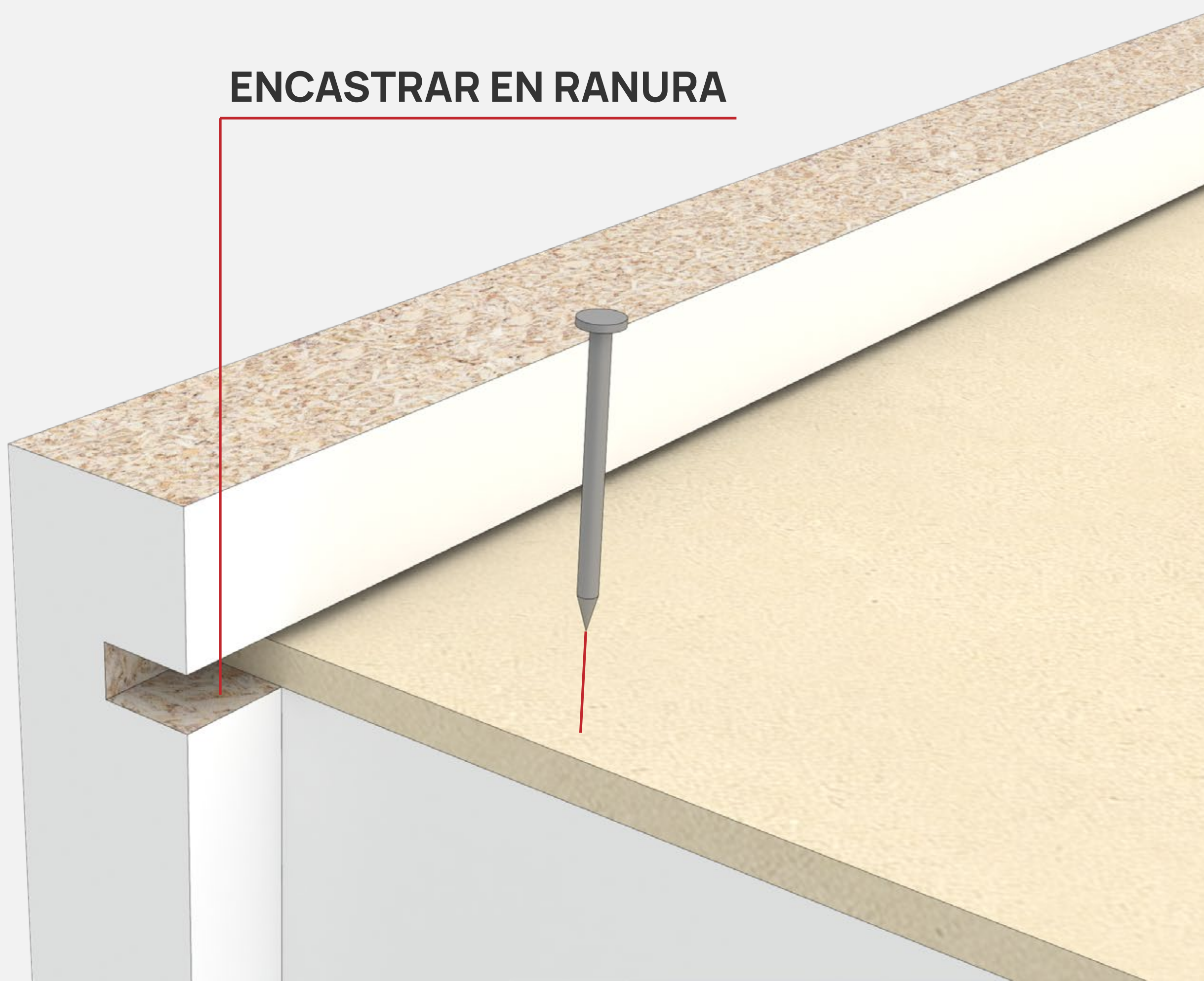

11

Colocar correderas

Colocar correderas en Cajones.
Cada corredera se vincula
con **2 tornillos 3.5x15.**

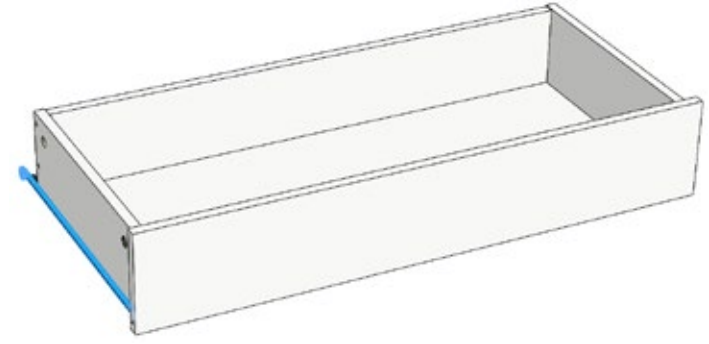

P6
Fondo
Cajón
813x362

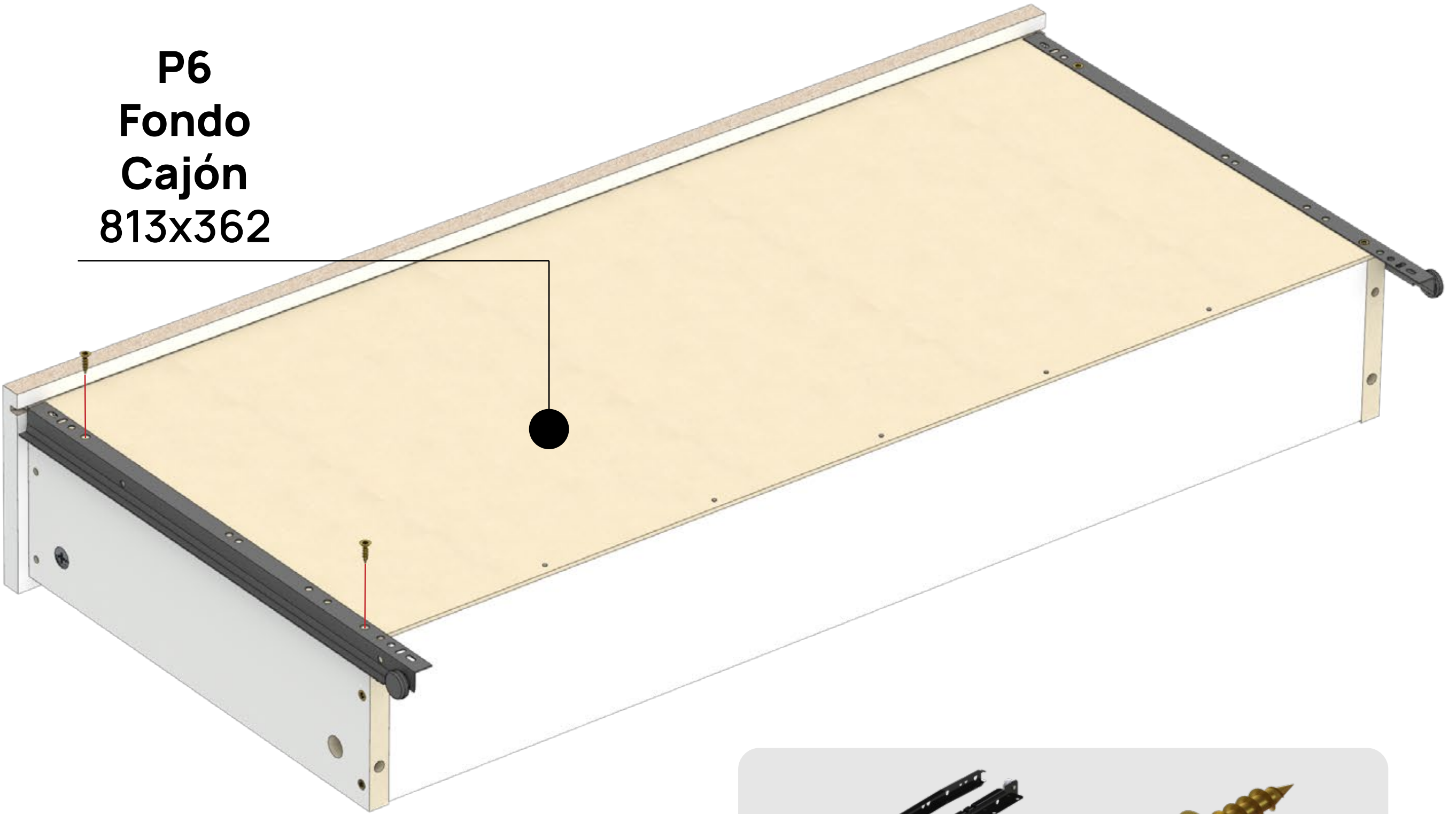

H3
Corredera
Z 400



H8
Tornillo
3.5x15

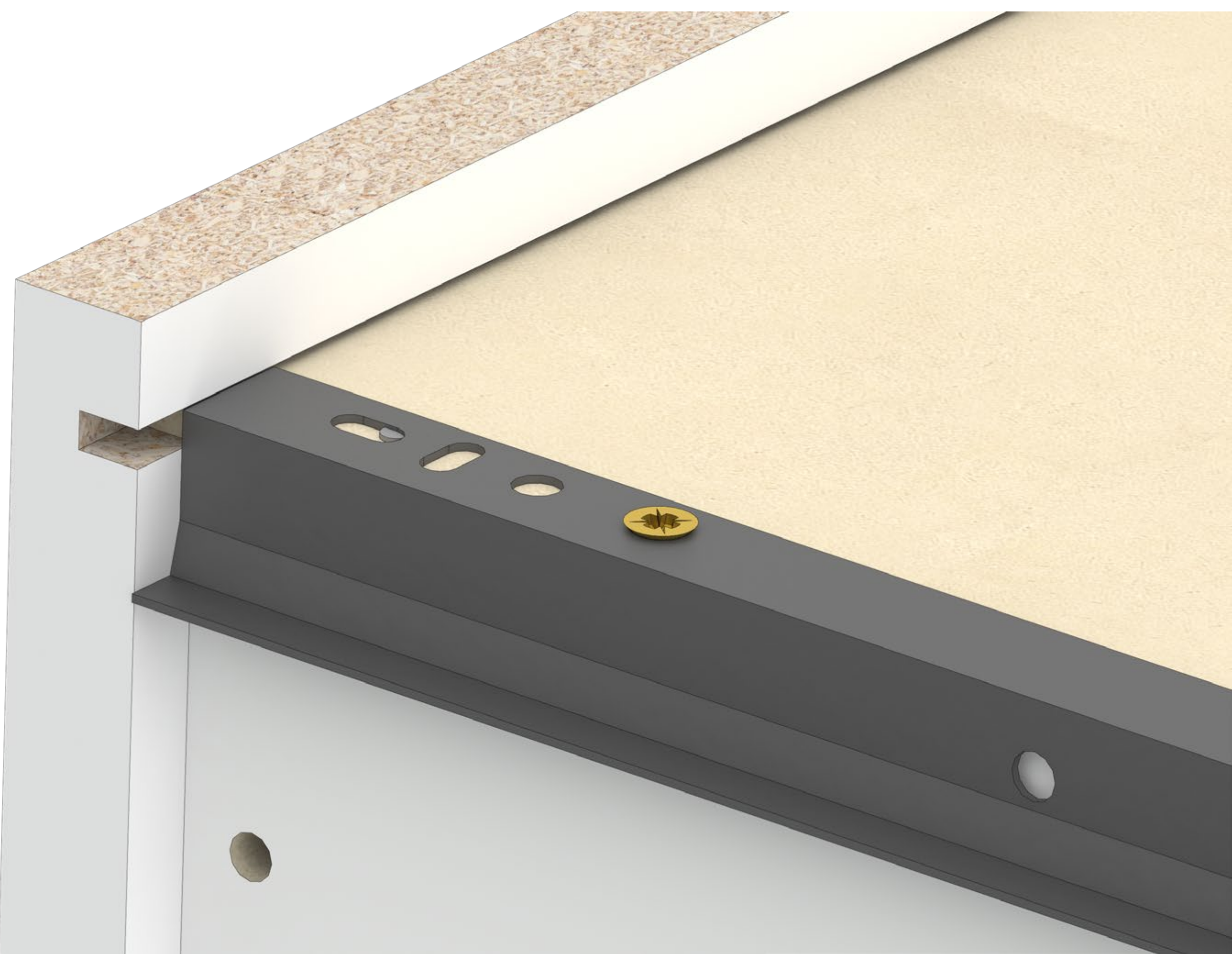

12

Colocar Aluminios

La guía superior se coloca oculta detrás de la cenefa. Los tornillos autoperf. actúan como mecha.



Guía superior aluminio - 1748

H17

H17

H17

H18 Kit Rueda + Freno



H19 Soporte Lat. barral

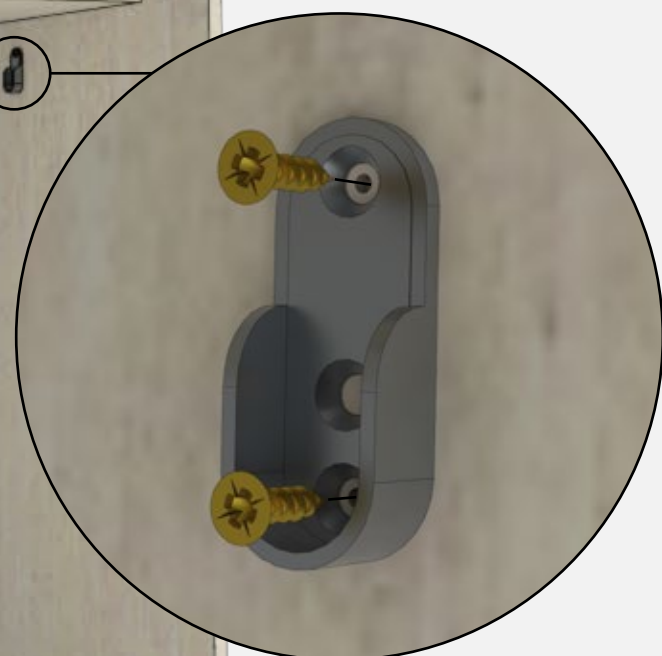

H17 Tornillo Autoperf.

H17 Tornillo Autoperf.

Guía inferior aluminio - 1748

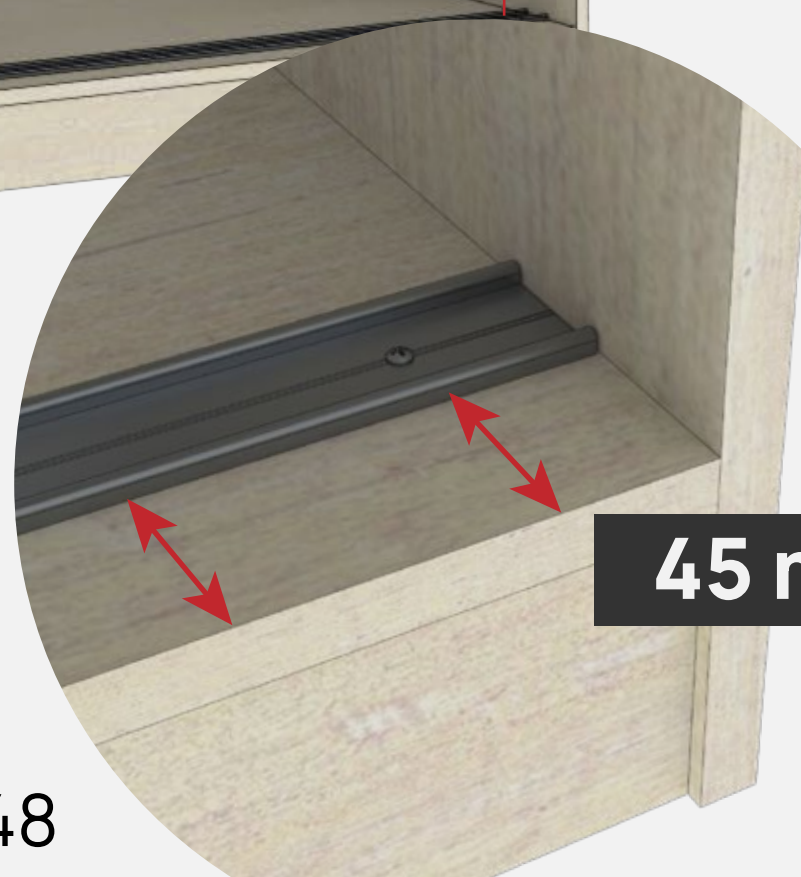

45 mm

H17

H17

H17

13

Armar puertas

Colocar ruedas superiores,
ruedas inferiores.

Encastrar manijas Athena

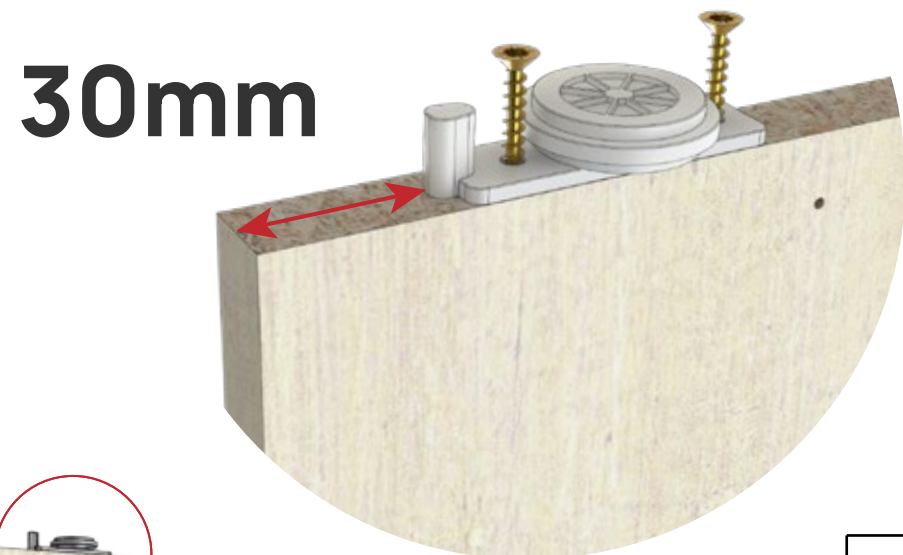
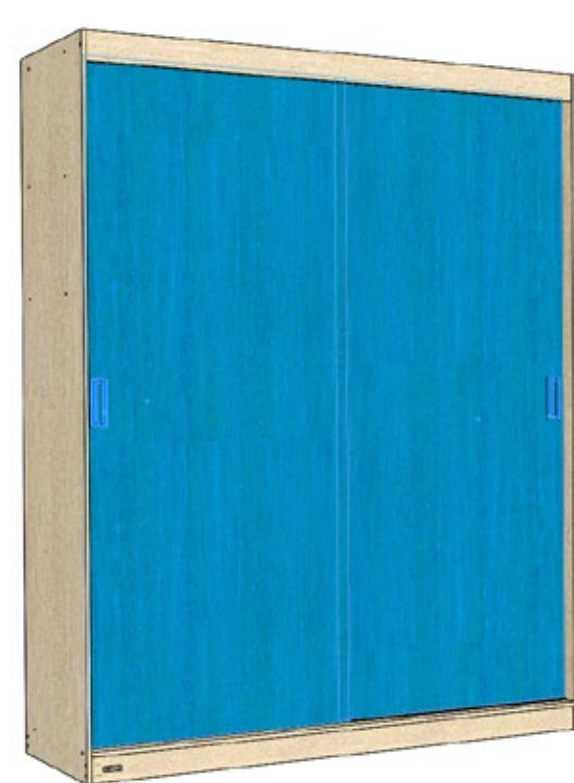

30mm

P19
Puerta BR 180
2043x883

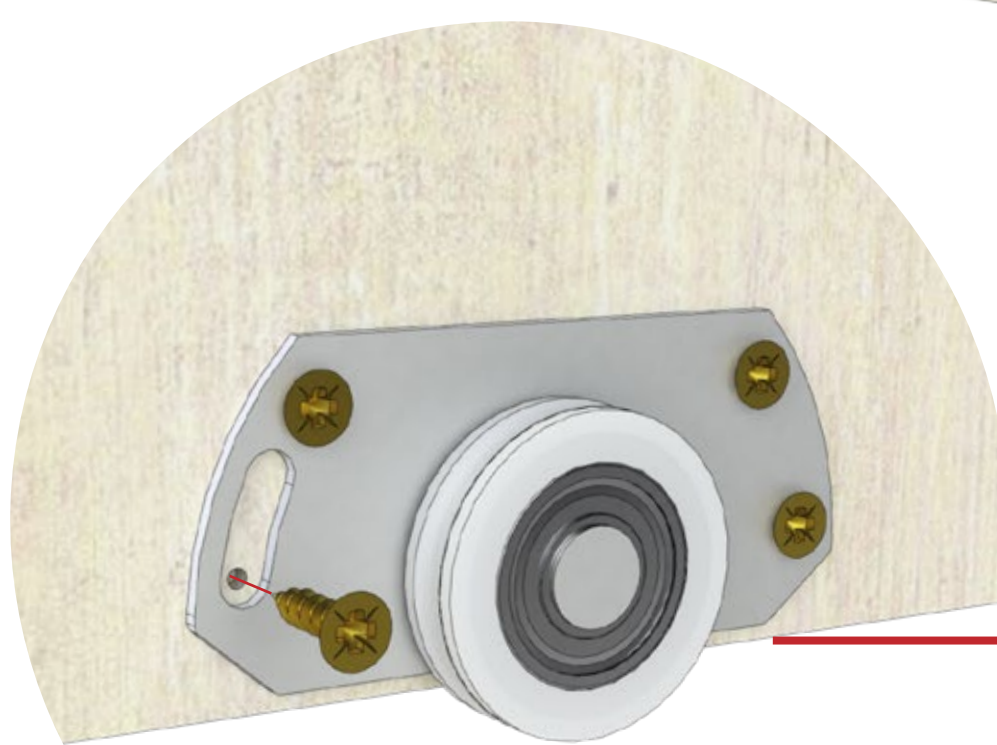

Dejar 2 mm
entre la rueda
y el canto inferior



H21
Manija
Athena

14

Cajones y barrales

Deslizar cajones como indica el gráfico.

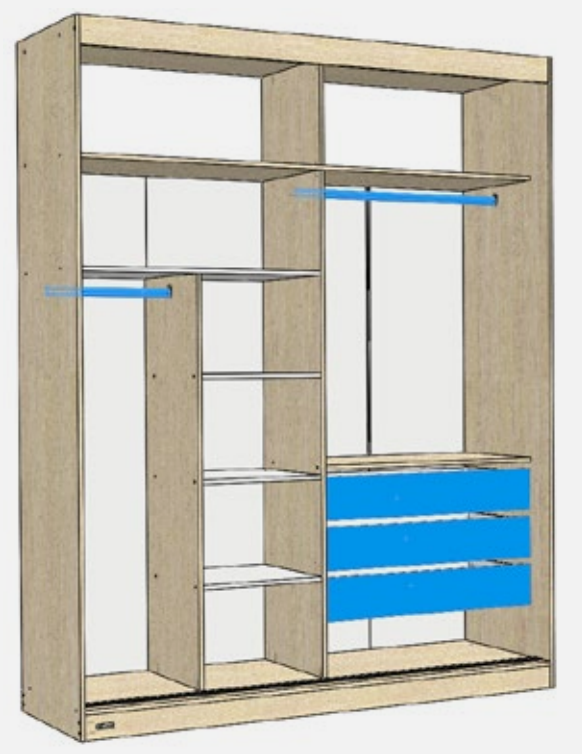

Barral de colgado - 433

Barral de colgado - 832



Corredera de costado

Corredera de cajón

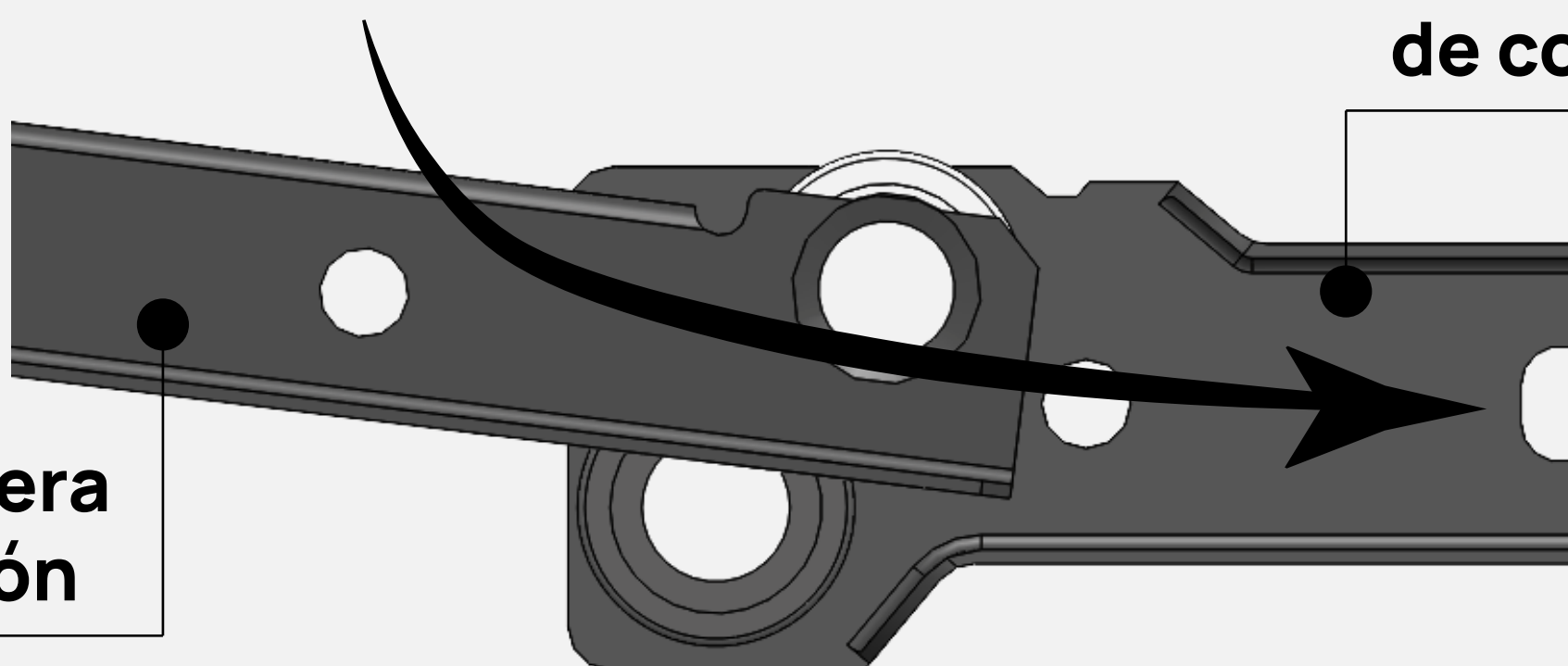

15

Colgar puertas

Colgar puertas como indica la flecha.

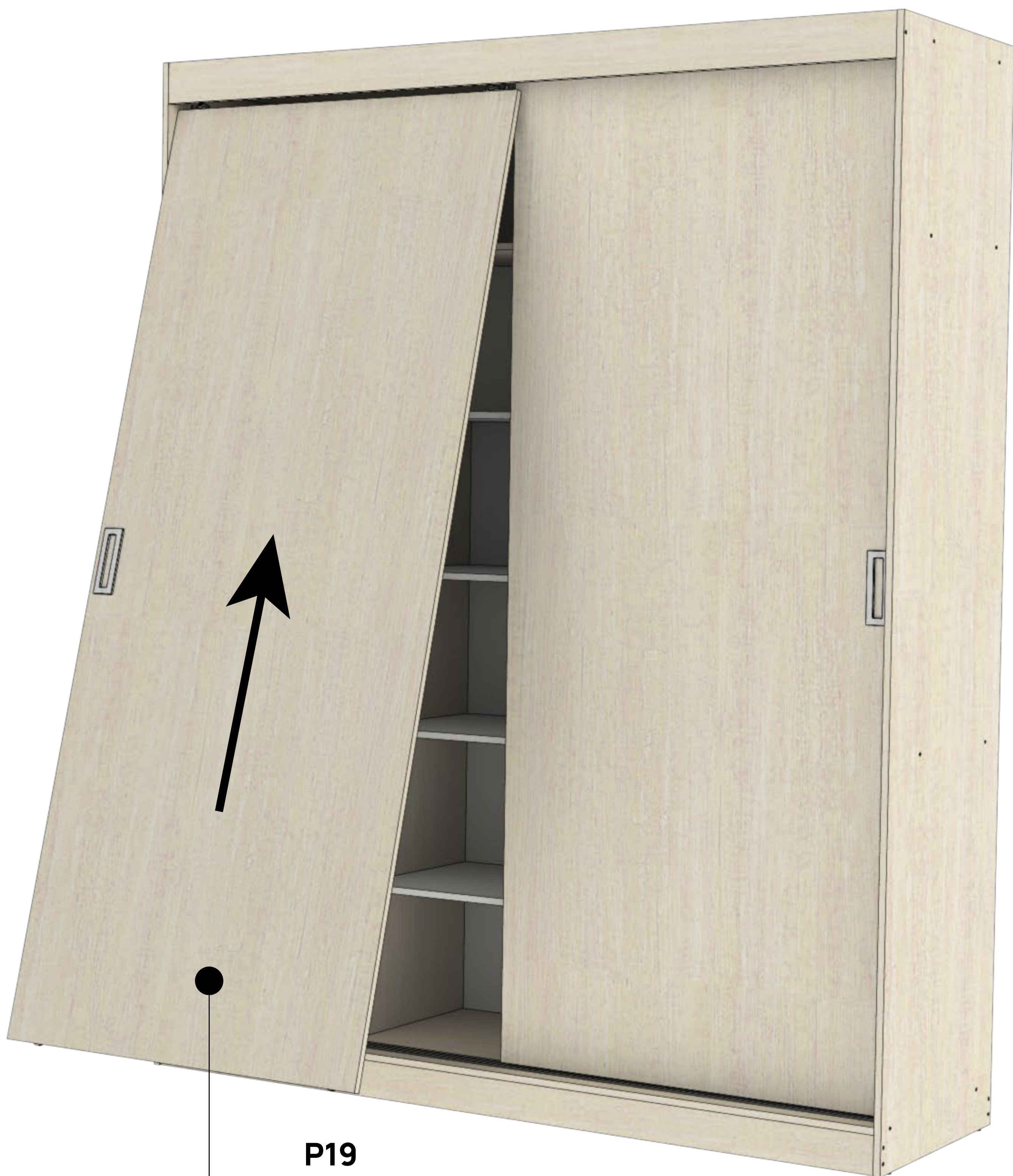
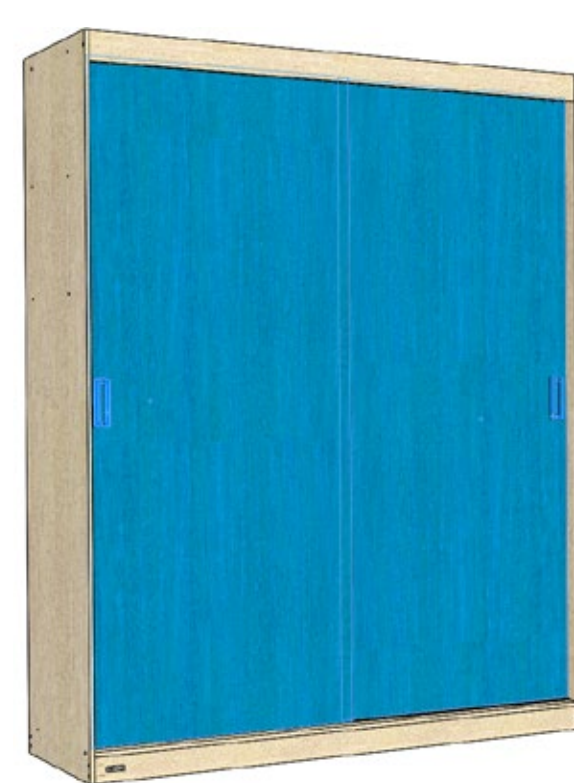

P19
Puerta BR 180
2043x883

**Apoyar 2 ruedas sobre riel frontal
y 2 en el posterior de la guía de aluminio**

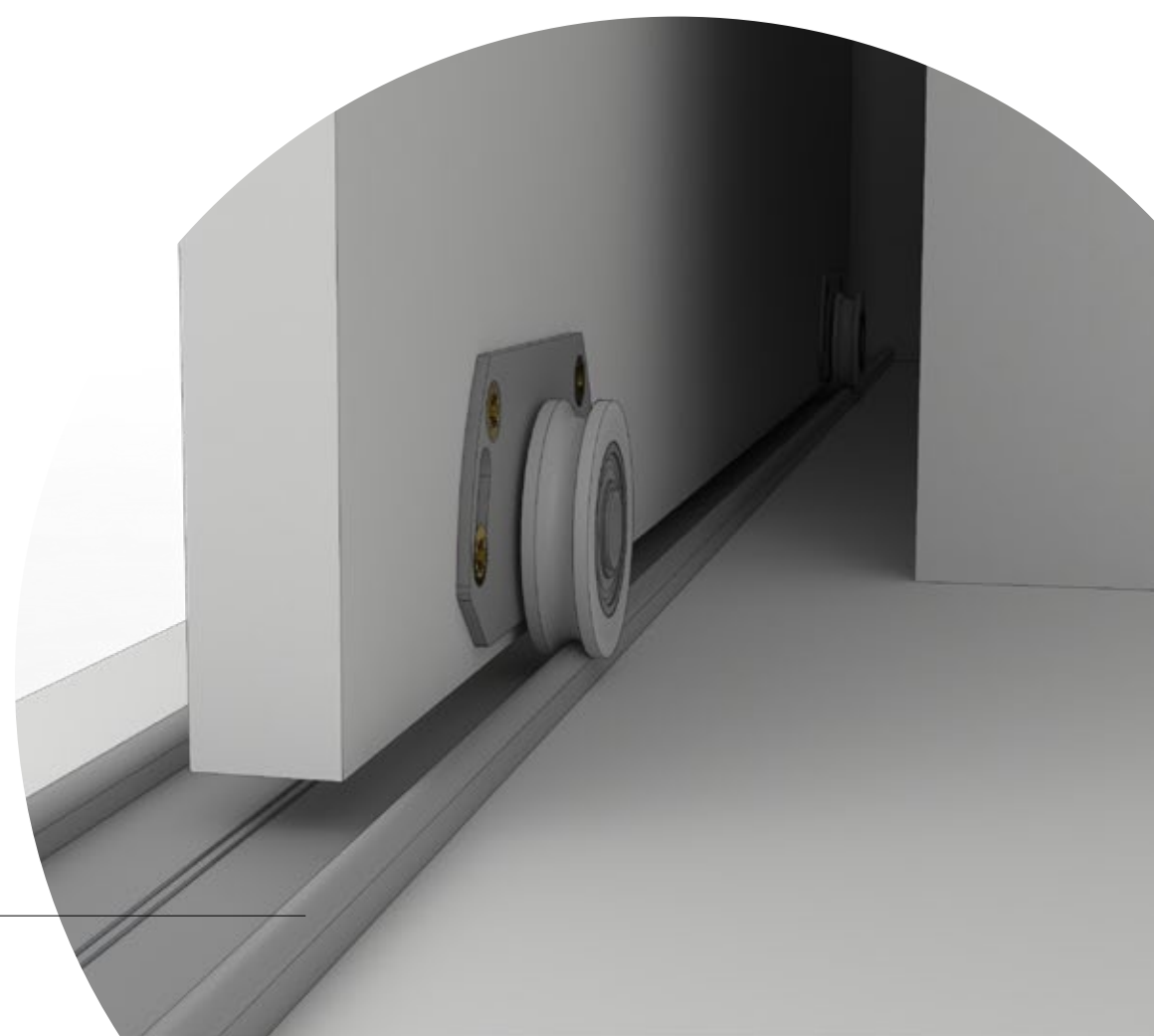

Terminaste!
Disfrutá tu Placard Velvet



#ExperienciaMosconi