

LOTE 1

Seguí los  
pasos  
y armá tu  
Placard **Velvet 220**



**COLGADO  
CORTO**

**MÁS ESPACIO  
DE GUARDADO**

**COLGADO  
CORTO**

**COLGADO LARGO**



**CAJONES**

**CAJONES**

**PERFILERÍA  
ALUMINIO**

**ESTANTES**

**Abrí la caja** y posicioná  
las piezas en el piso.

**CAJA 1  
DE 4**

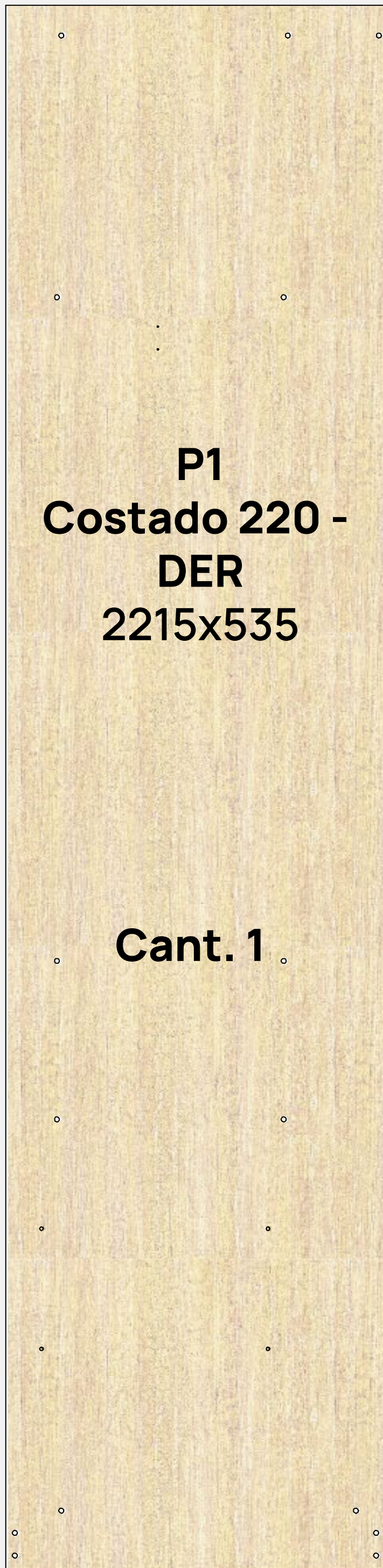

**P1  
Costado 220 -  
DER  
2215x535**

**Cant. 1**

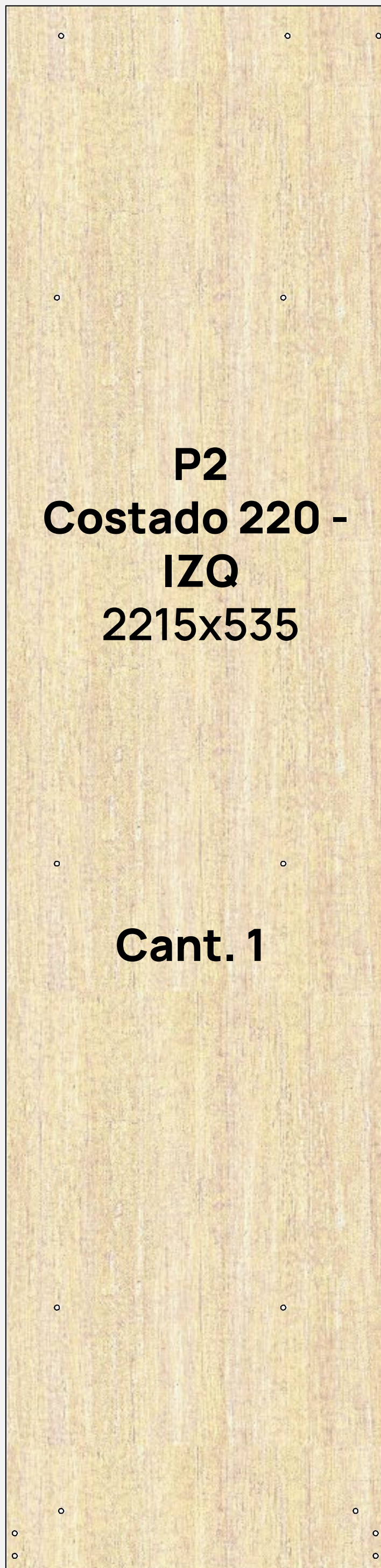

**P2  
Costado 220 -  
IZQ  
2215x535**

**Cant. 1**

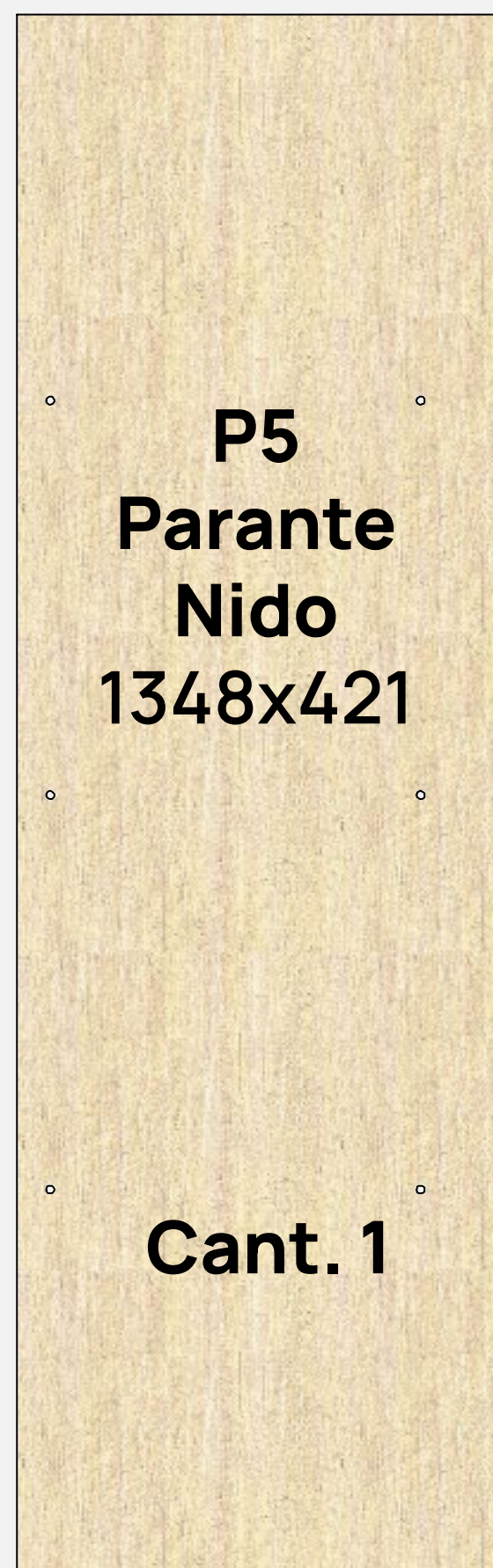

**P5  
Parante  
Nido  
1348x421**

**Cant. 1**

**P4 Estante  
corto  
420x380  
Cant. 3**

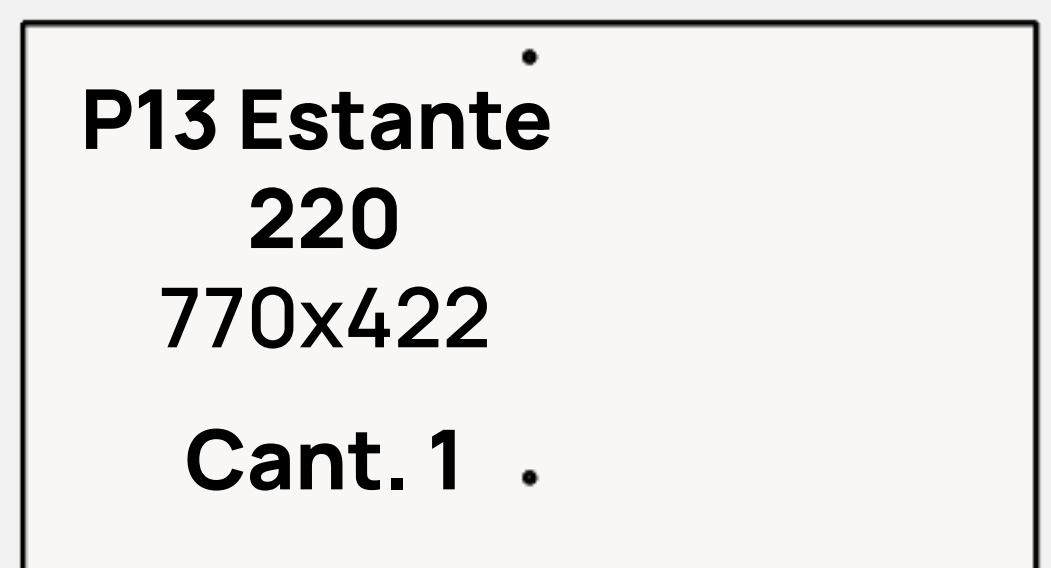

**P13 Estante  
220  
770x422  
Cant. 1**

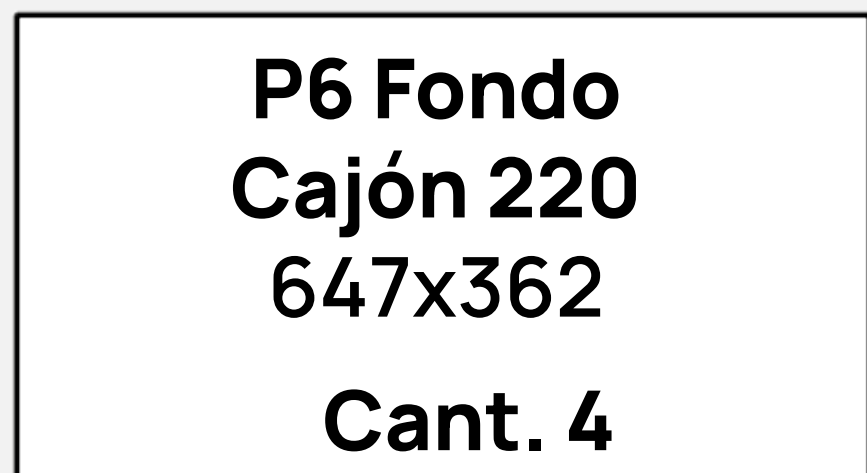

**P6 Fondo  
Cajón 220  
647x362  
Cant. 4**



**P10 Zócalo central**

**495x80  
Cant. 2**



**P8 Frente Cajón 220**

**667x145  
Cant. 4**



**P9 Contrafrente  
Cajón 220**

**619x118  
Cant. 4**



Protección caja  
No se usa  
en armado

**P11 Puntera**

**530x70  
Cant. 2**

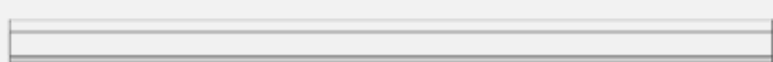

Barral de colgado - 368

**Cant. 4**

Barral de colgado - 668

**Cant. 2**

Guía superior inferior - 2148 **Cant. 1**

Guía superior aluminio - 2148 **Cant. 1**

**Abrí la caja** y posicioná las piezas en el piso.

**CAJA 2  
DE 4**

**P17**  
**Techo 220**  
2150x519

**Cant. 1**

**P15**  
**Base 220**  
2150x535

**Cant. 1**

**P12**  
**Divisorio 220**  
2150x424

**Cant. 1**

**P20**  
**Fondo Inf**  
**220**  
1718x393

**Cant. 2**

**P22**  
**Fondo Sup**  
**220**  
1084x372

**Cant. 2**

**P23 Cenefa 220 2150x90**

**Cant. 1**

**P24 Zócalo 220 Del 2150x80**

**Cant. 1**

**P25 Zócalo 220 Tras 2150x80**

**Cant. 1**

Protección caja  
No se usa  
en armado

**P18 Puntera**

**530x64**  
**Cant. 2**

**Abrí la caja** y posicioná  
las piezas en el piso.

**CAJA 3  
DE 4**

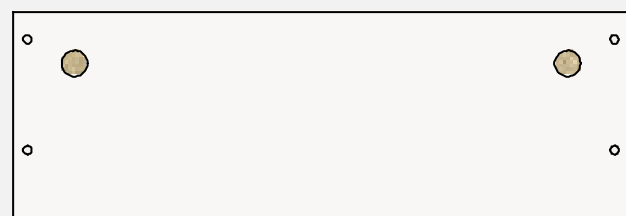
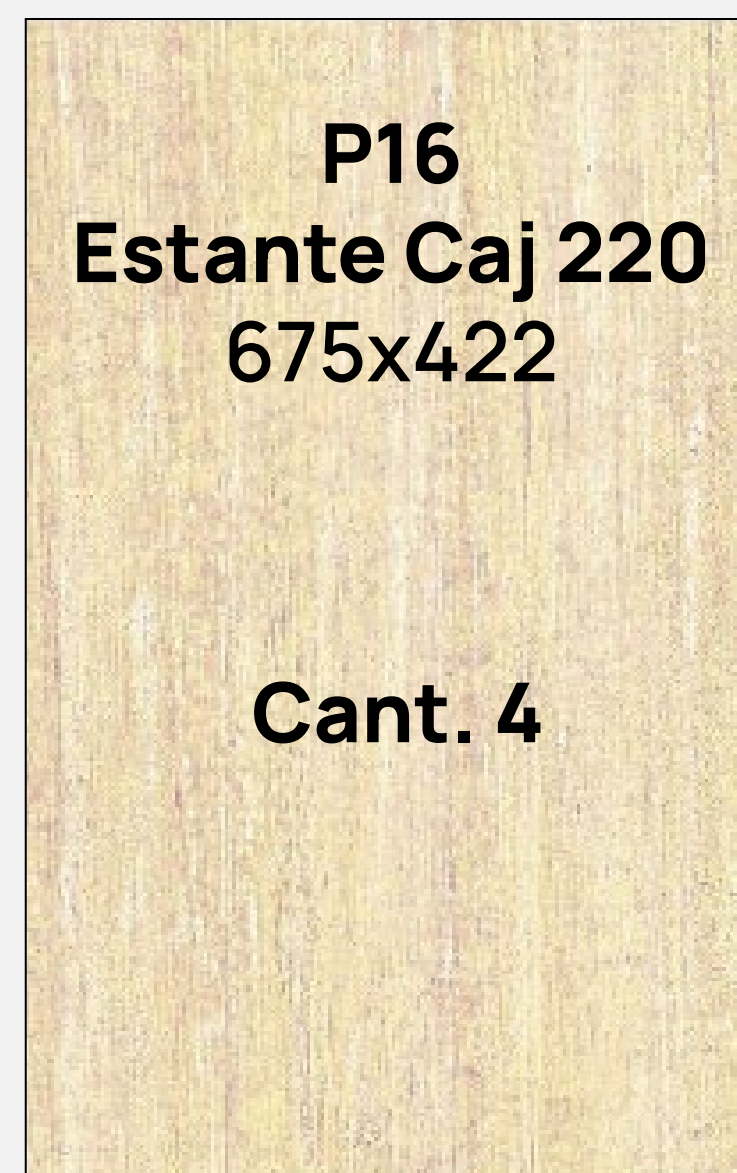
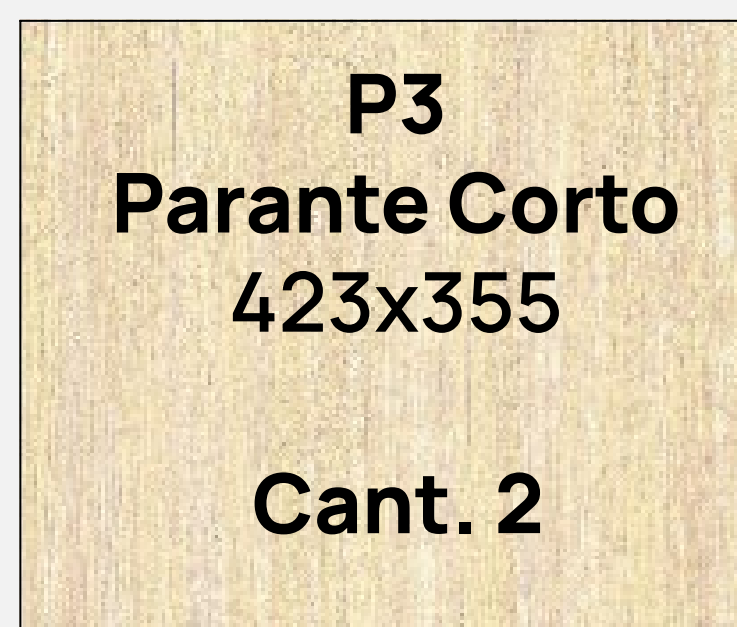
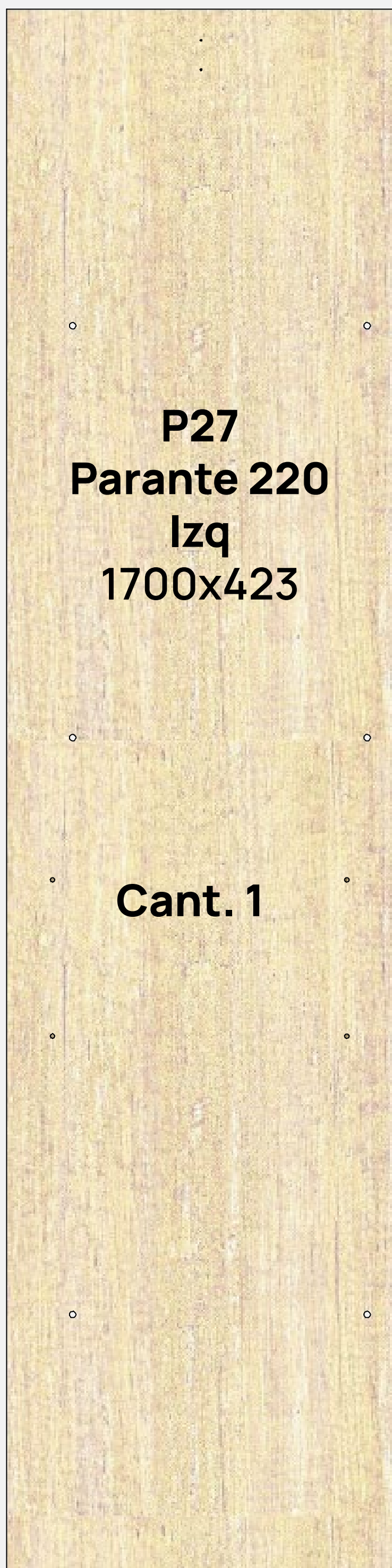
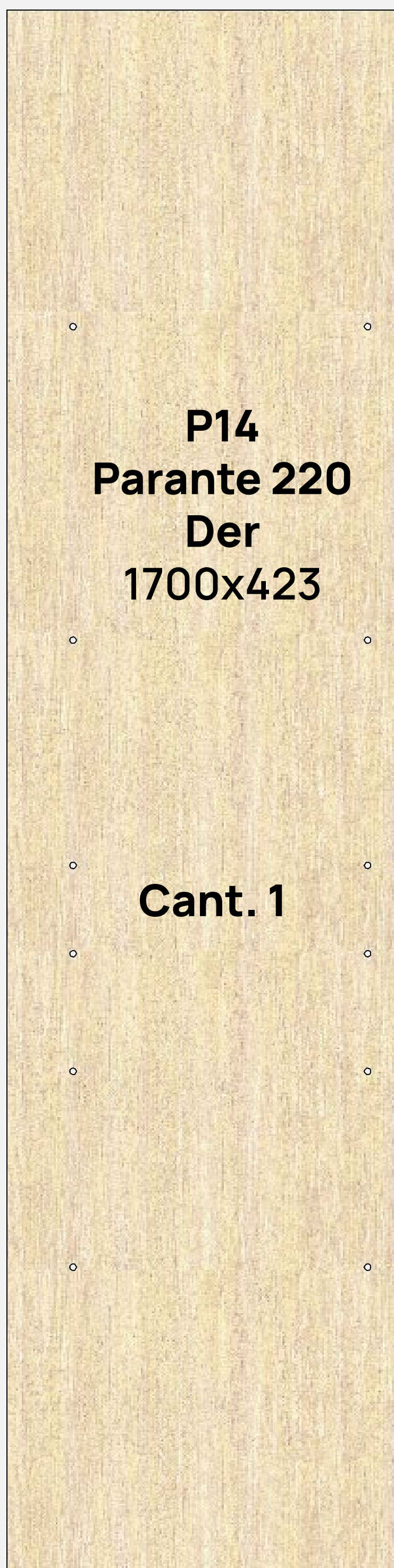

**P7 Lateral**  
**Cajon**

**355x120**  
**Cant. 8**



**P26 Puntera 220**

**418x70**  
**Cant. 2**

**Abrí la caja** y posicioná las piezas en el piso.

**CAJA 4  
DE 4**

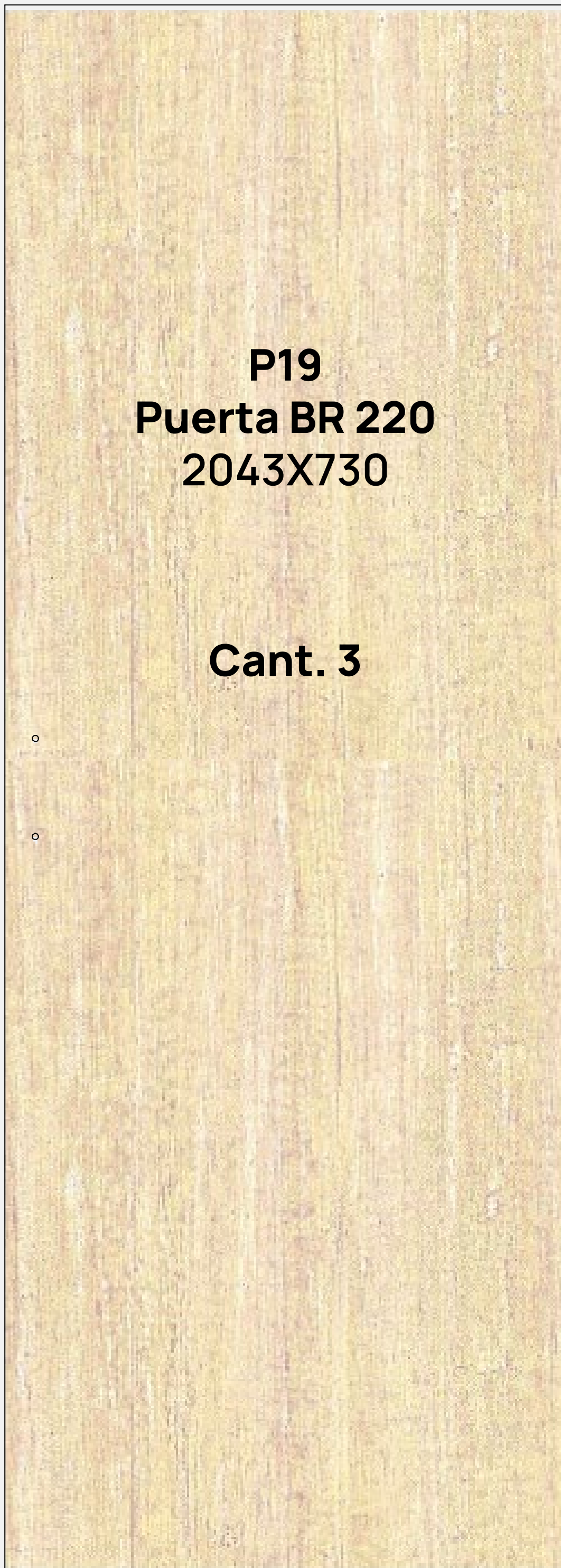

**P19  
Puerta BR 220  
2043X730**

**Cant. 3**

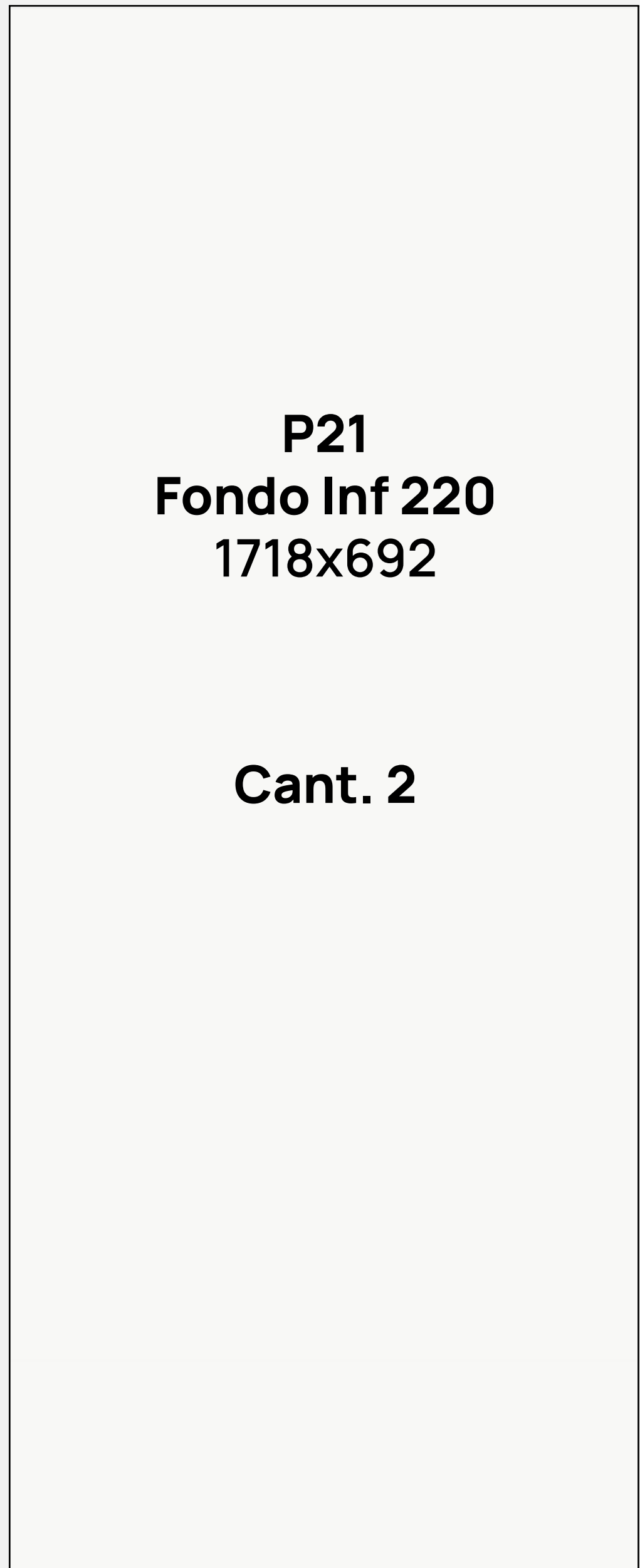

**P21  
Fondo Inf 220  
1718x692**

**Cant. 2**



**P28 Puntera 220**

**725x46  
Cant. 2**

# Herrajes



**H1**  
Tornillo  
variante 6x8

**16 ud.**



**H2**  
Tornillo  
6.3x50 Allen

**66 ud.**



**H3**  
Corredera  
Z 400

**4 ud.**

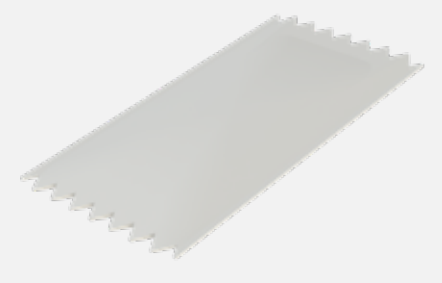

**H4**  
Sachet de  
Cola 10 grs.

**2 ud.**



**H5**  
Tarugo  
6x30

**14 ud.**



**H6**  
Base plástica  
redonda

**8 ud.**

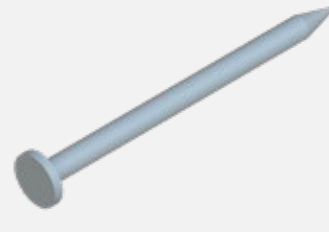

**H7**  
Clavo

**1 bolsa**



**H8**  
Tornillo  
3.5x15

**54 ud.**



**H9**  
Escuadra  
plástica

**1 ud.**



**H10**  
Tarugo  
8x50

**4 ud.**



**H11**  
Tornillo  
4x25

**3 ud.**



**H12**  
Trapecio

**3 ud.**



**H14**  
Cazoleta  
minifix

**8 ud.**



**H15**  
Perno  
minifix

**8 ud.**



**H16**  
Tornillo  
3.5x30

**28 ud.**



**H17**  
Tornillo Autoperf.  
3.6x13

**10 ud.**



**6 ud.**



**2 ud.**

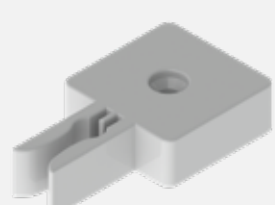

**2 ud.**



**6 ud.**



**H19**  
Soporte  
Lat. barral

**6 ud.**



**H20**  
Marca  
Empresarial

**1 ud.**



**H21**  
Manija  
Athena

**3 ud.**

**H18**  
Kit Rueda  
+Freno

**1 ud.**

# ¿Qué herramientas necesito?



**Para cuidar las piezas  
armá el placard sobre la caja.**

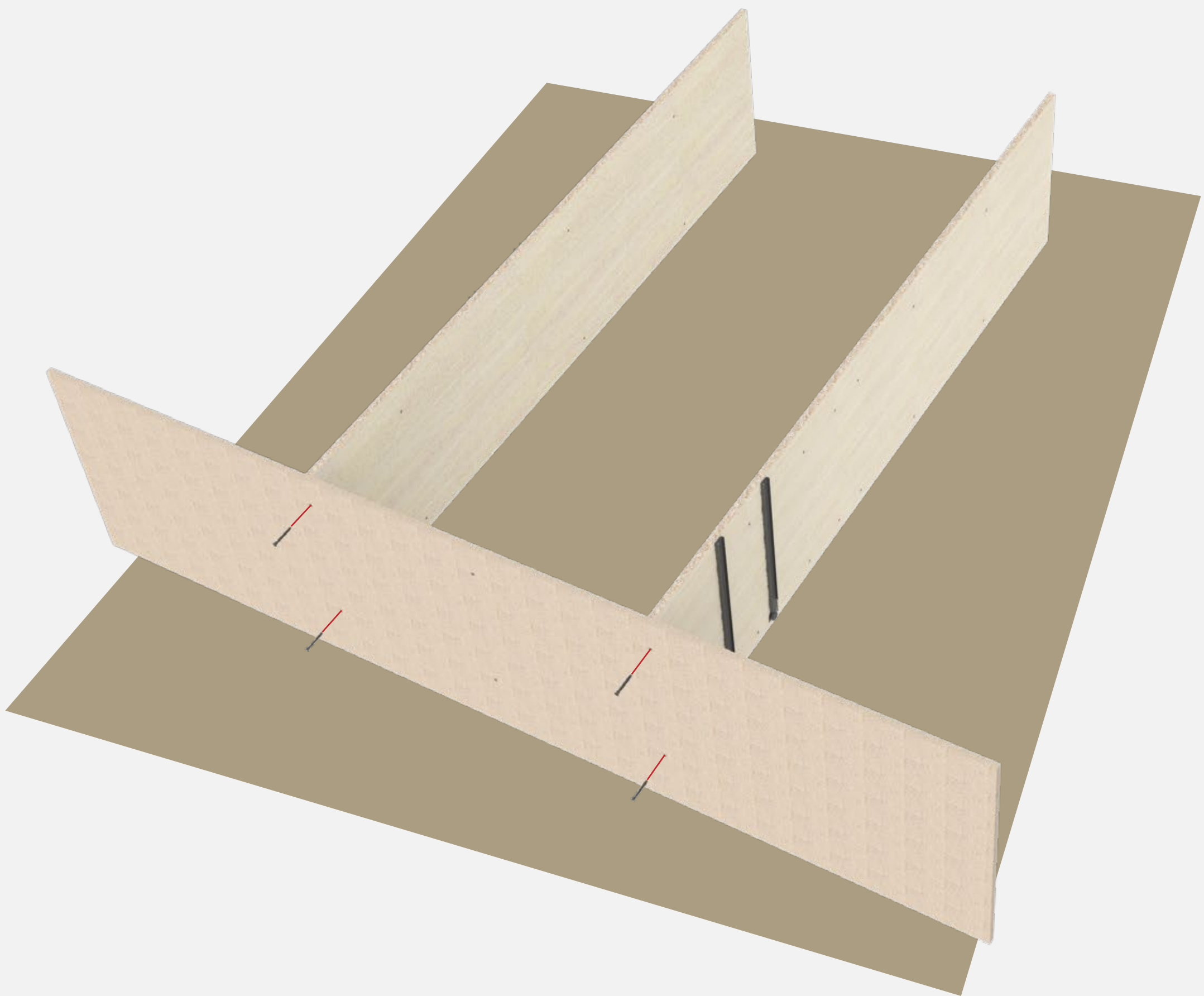

**Al momento de rotar, recomendamos  
que sean dos personas.**

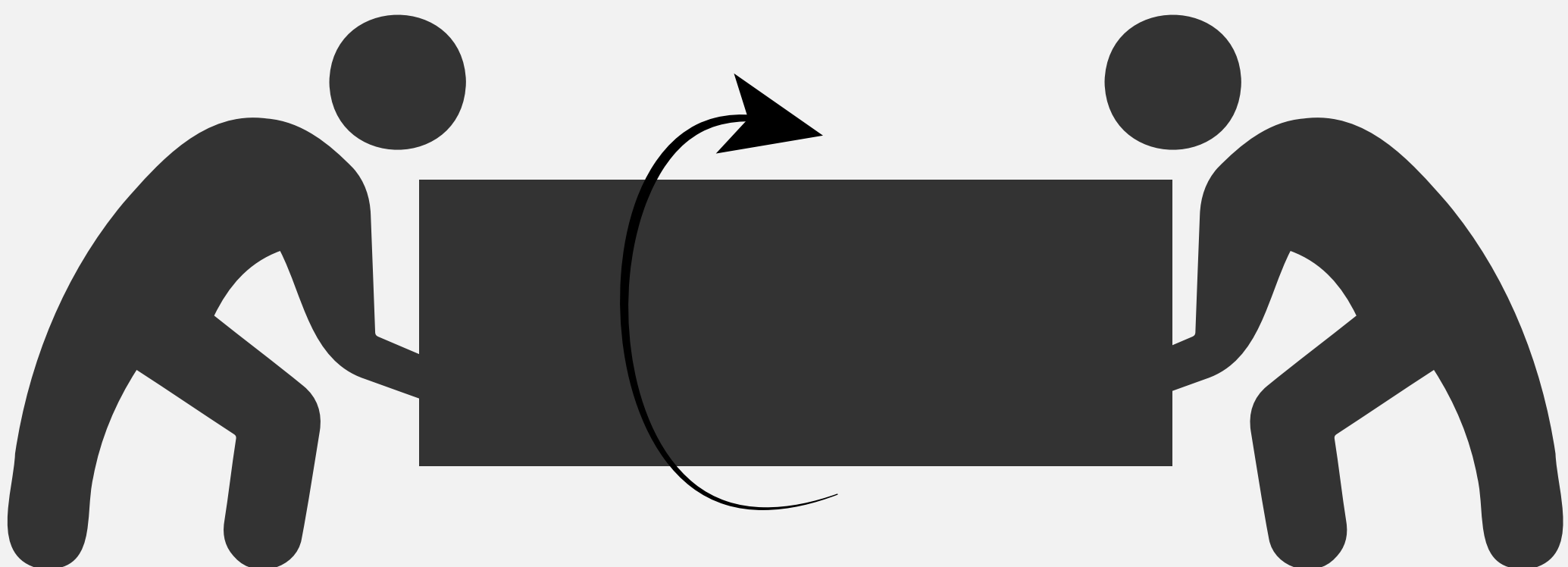

# 01

## Colocar correderas

Vincular 2 correderas en parante derecho y 2 en parante izq.  
Unir con 2 tornillos varianta cada una de las correderas.

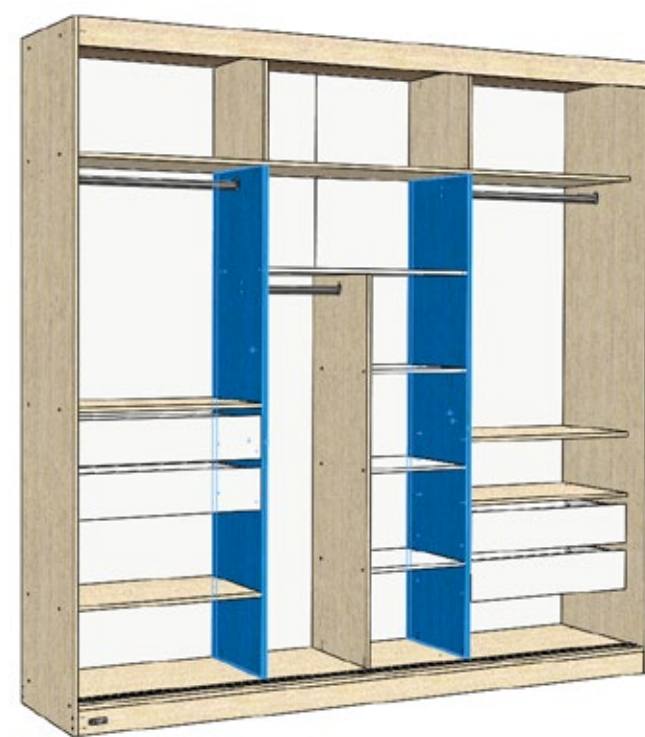

**P27**  
**Parante 220**  
**Izq**  
**1700x423**

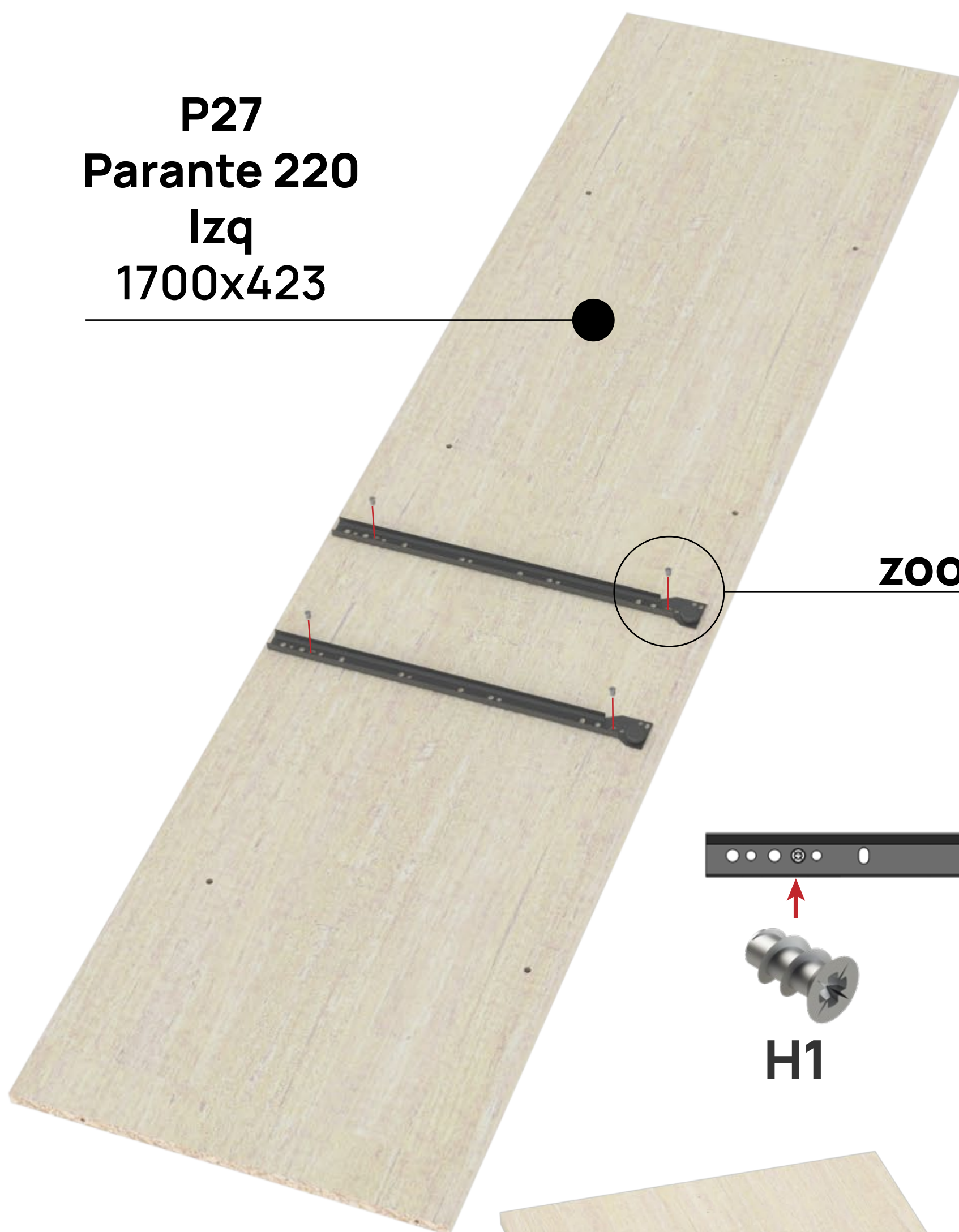

zoom

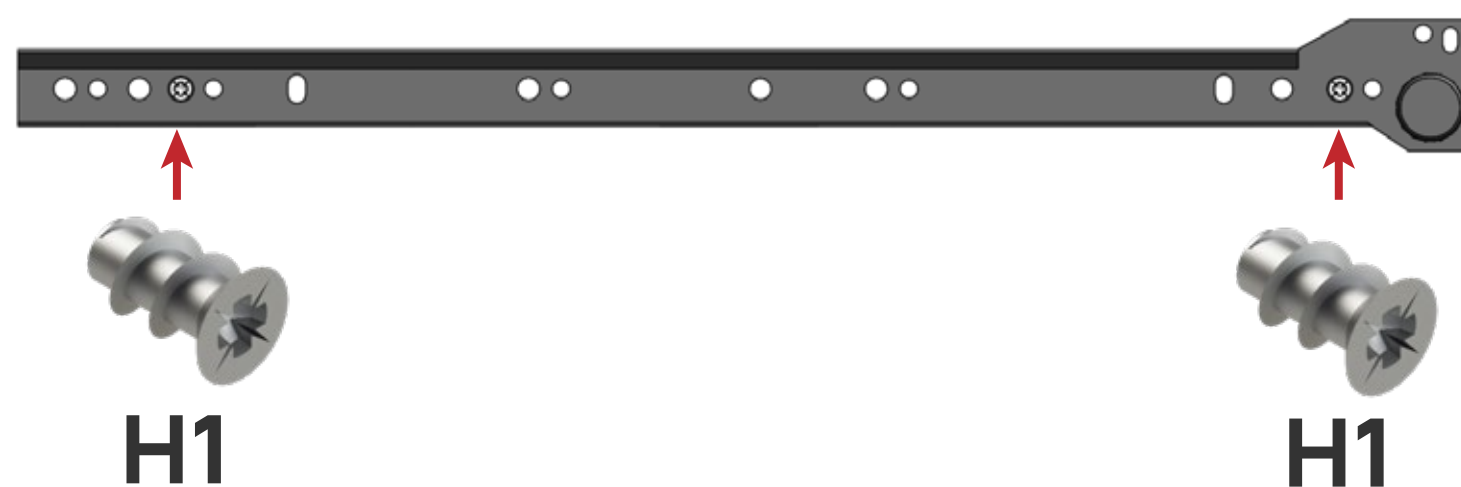
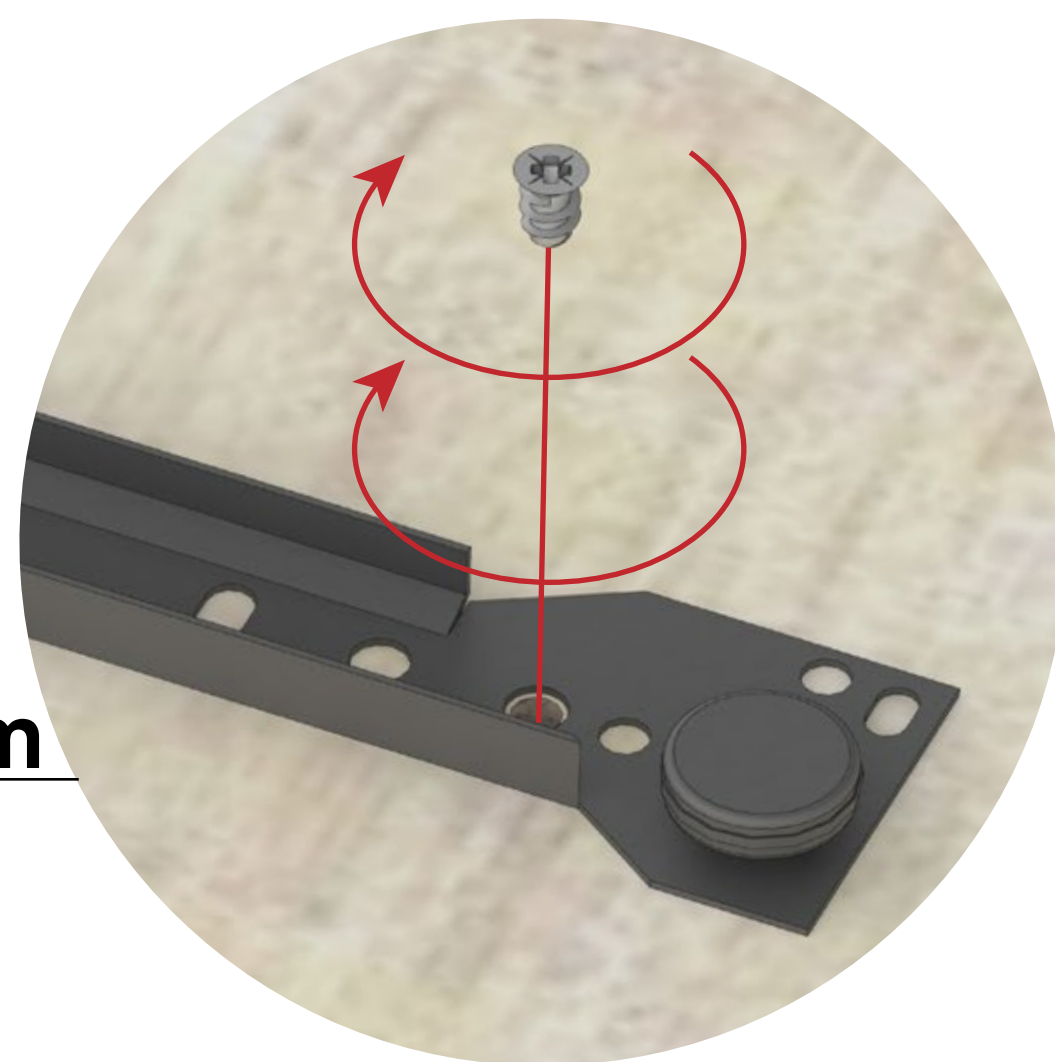

**P14**  
**Parante 220**  
**Der**  
**1700x423**

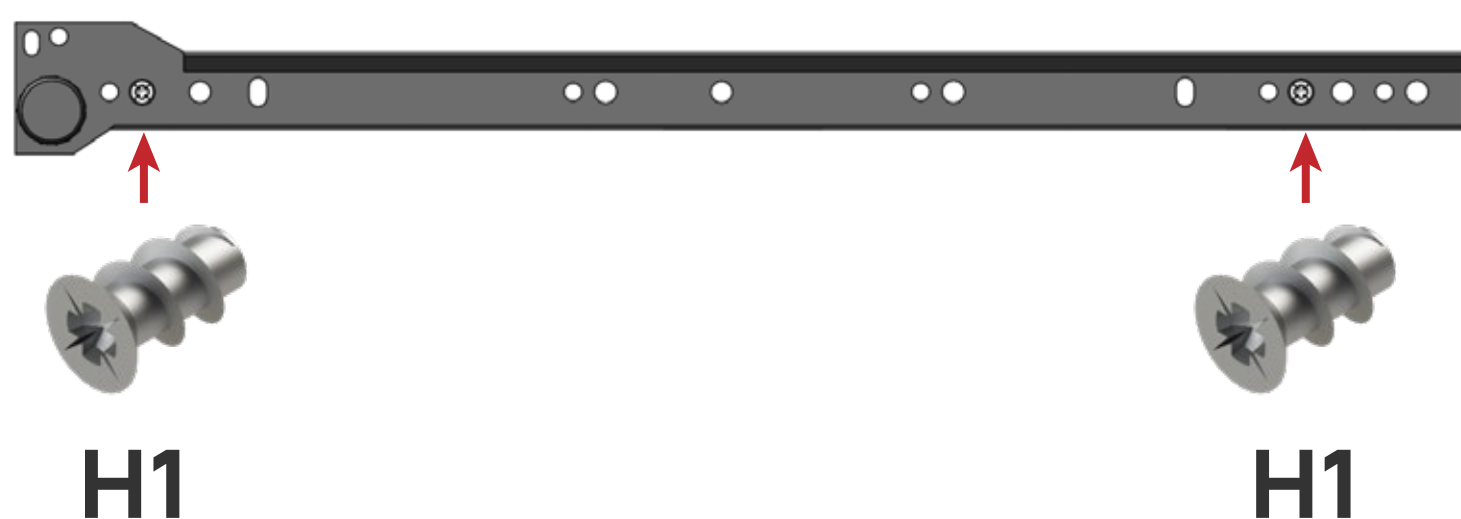
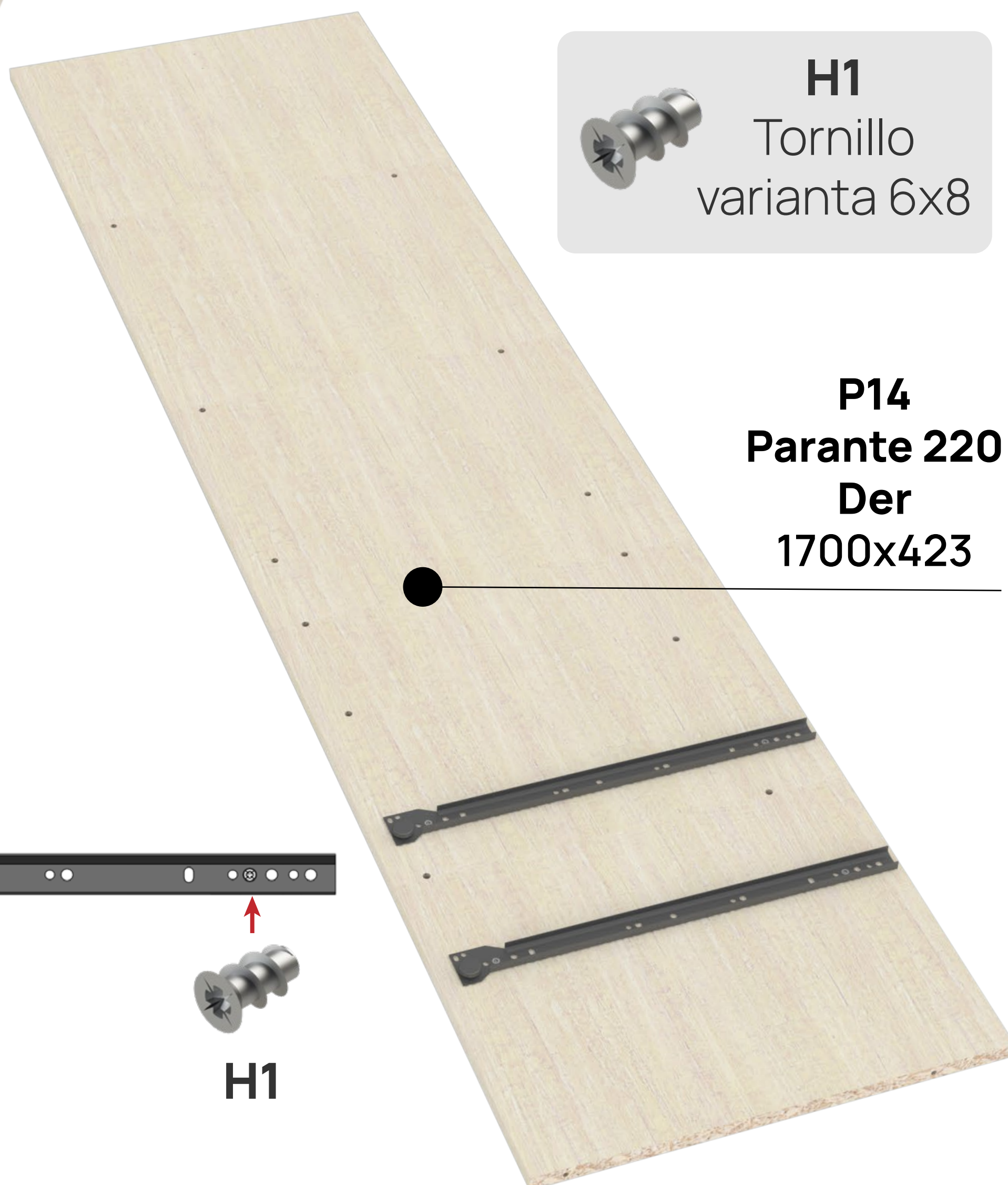

# 02

## Colocar parantes

Vincular 2 parantes con base.  
**IMPORTANTE:** El filo melamino queda orientado hacia abajo (piso)

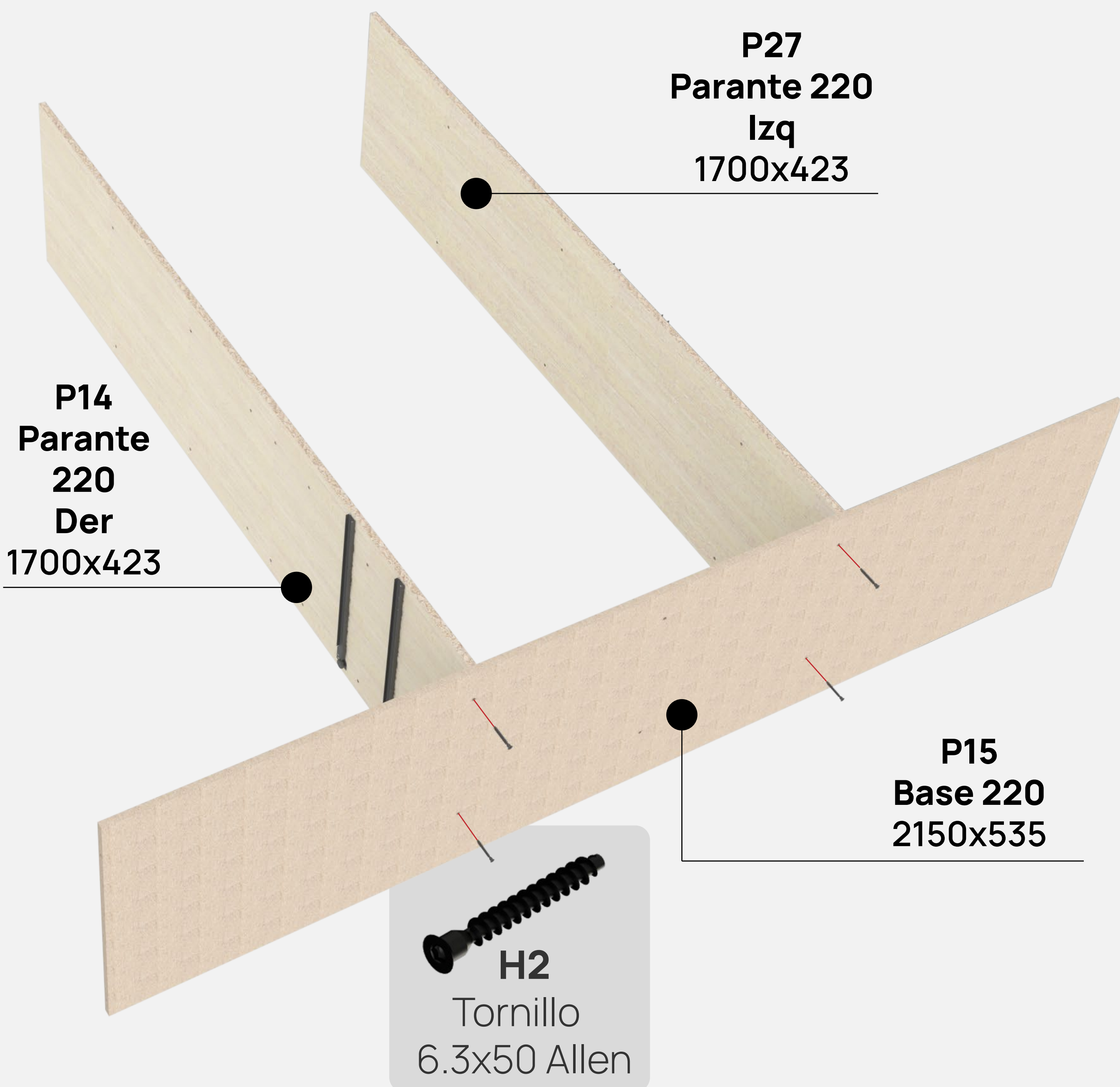
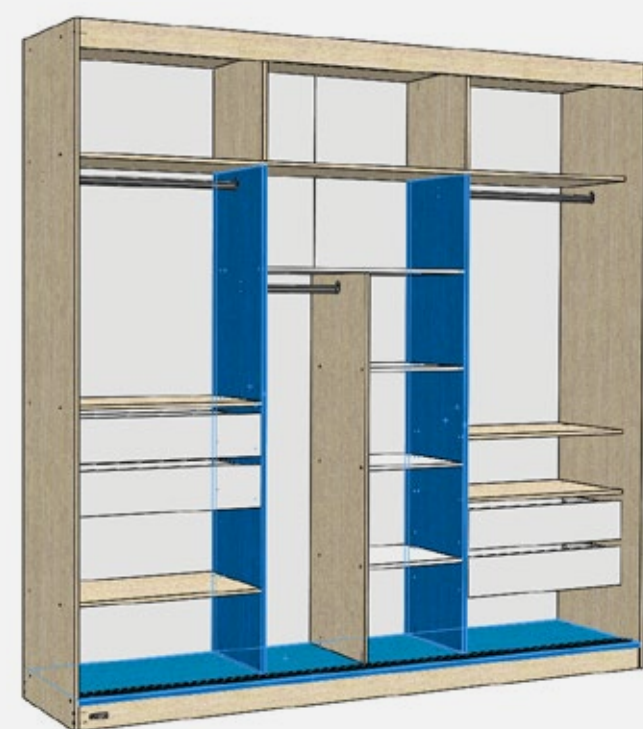

# 03

## Colocar correderas

Vincular 2 correderas en costado derecho y 2 en costado izq. Unir con 2 tornillos varianta cada una de las correderas.

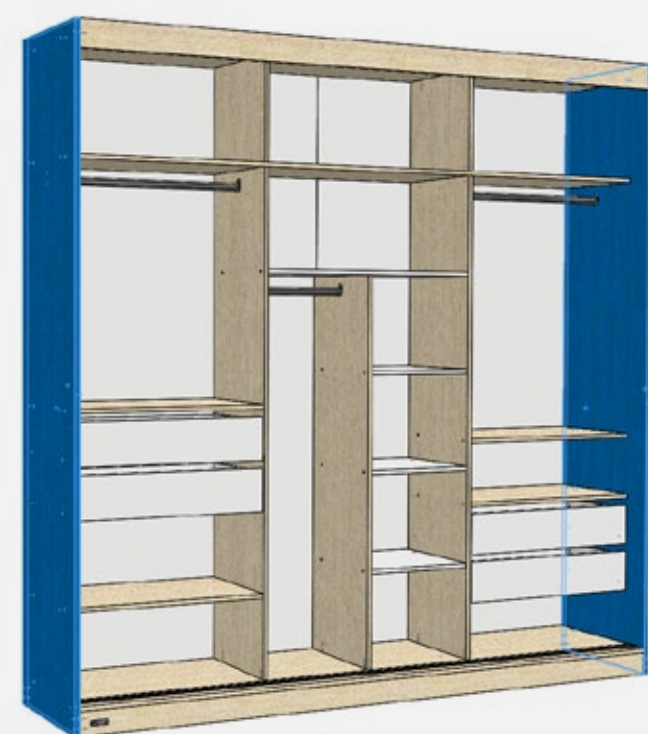

**P1**  
**Costado 220 -**  
**DER**  
2215x535

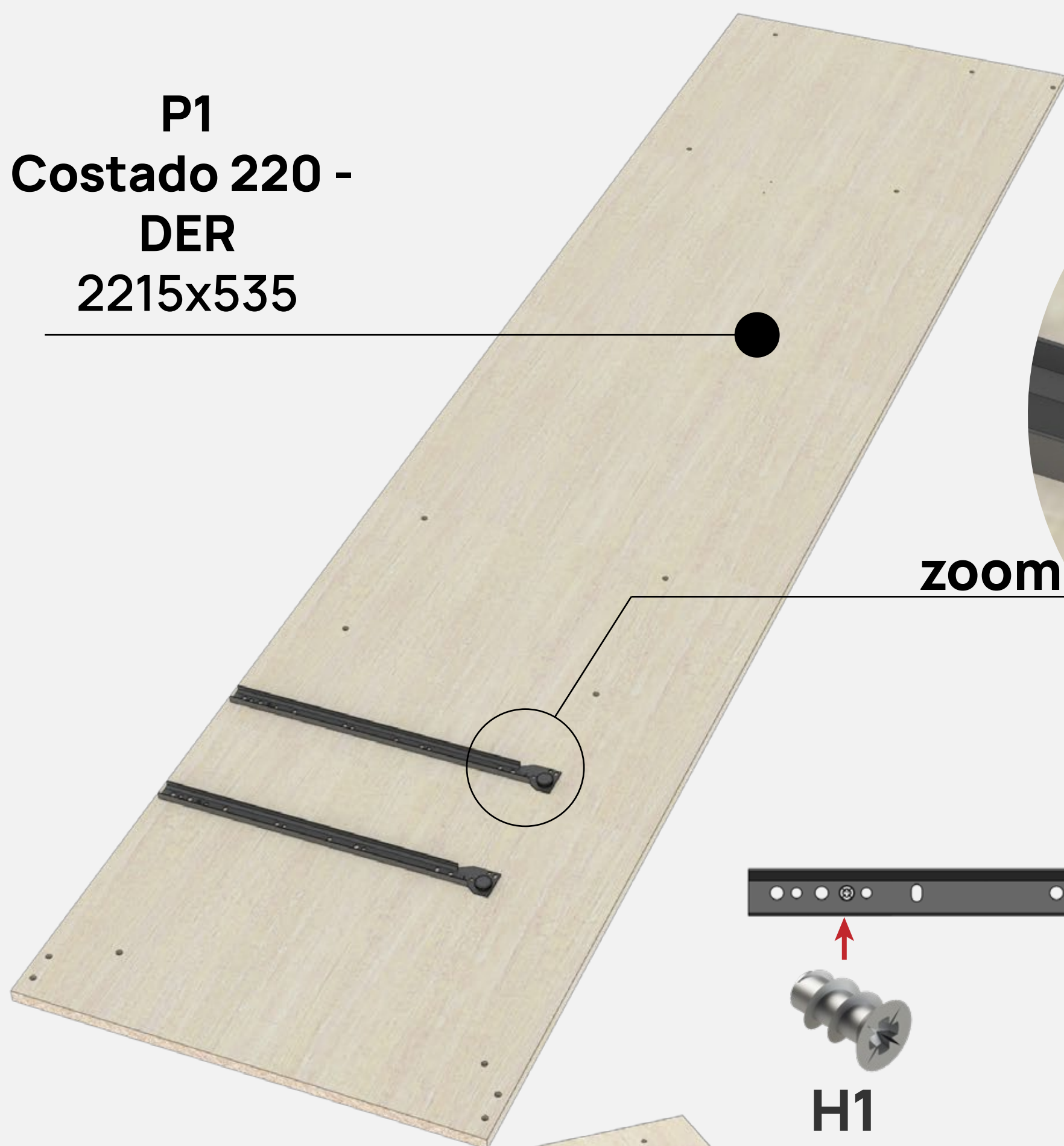

**P1**  
**Costado 220 -**  
**IZQ**  
2215x535

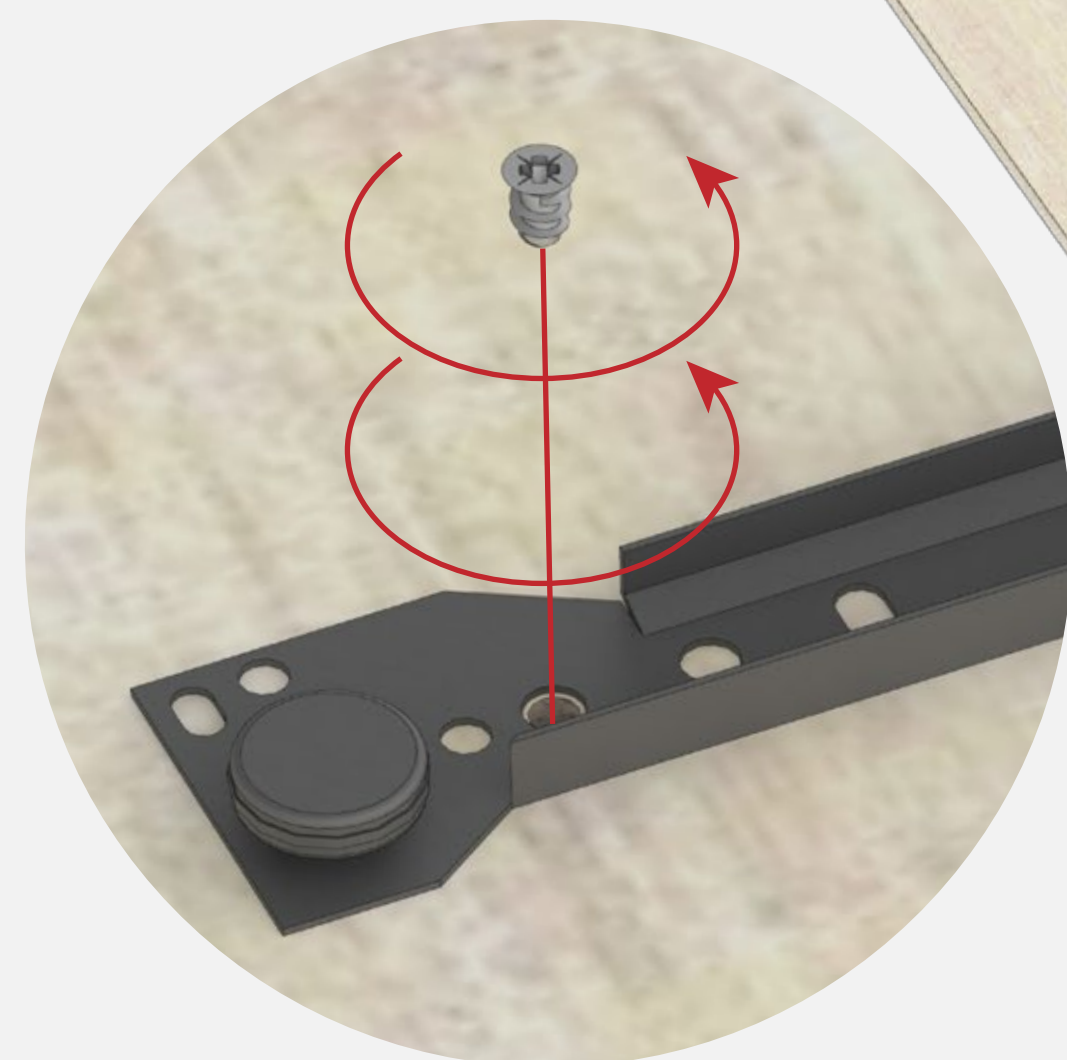

# 04

## Armar estructura

Vincular las piezas que se ven en la imagen, utilizando 12 tornillos Allen 6.3x50.  
Colocar a presión 4 tarugos.

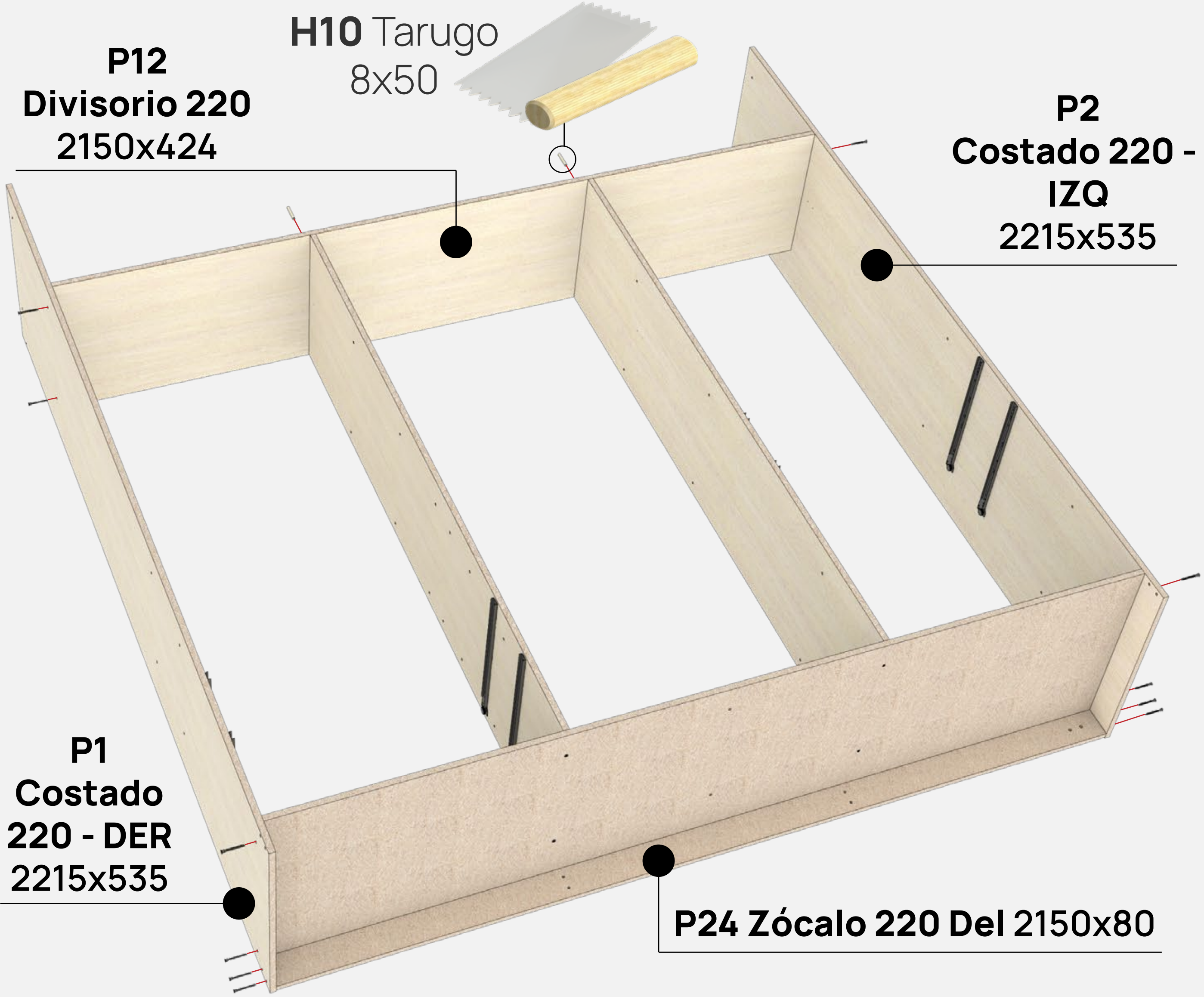

# 05

## Armar estructura

Colocar zócalo central y luego vincular zócalo trasero.

Encolá las perforaciones antes de colocar tarugos.



P3 Parante Corto 423x355



**H5**  
Tarugo  
6x30

**P10 Zócalo  
central  
495x80**

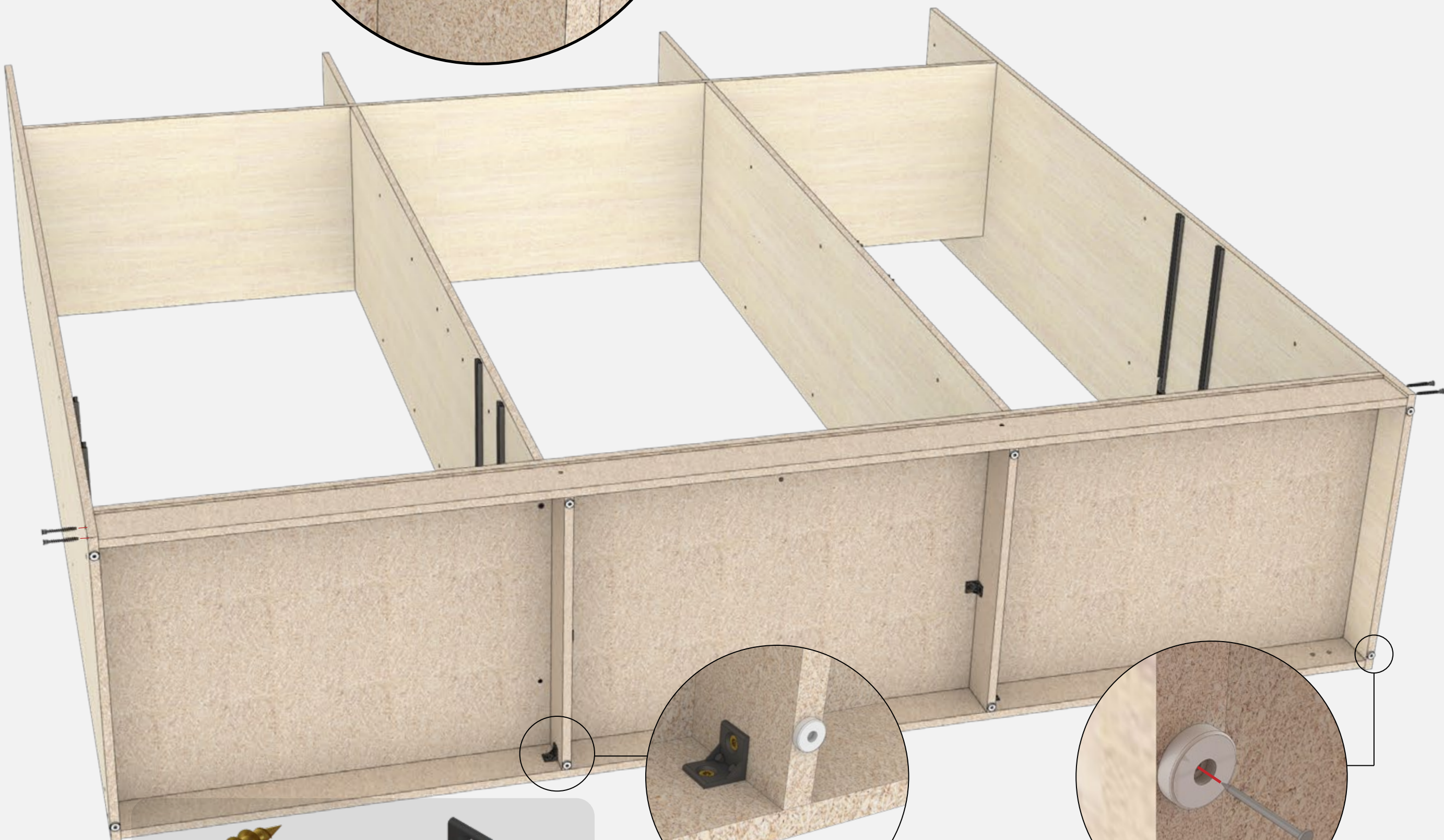
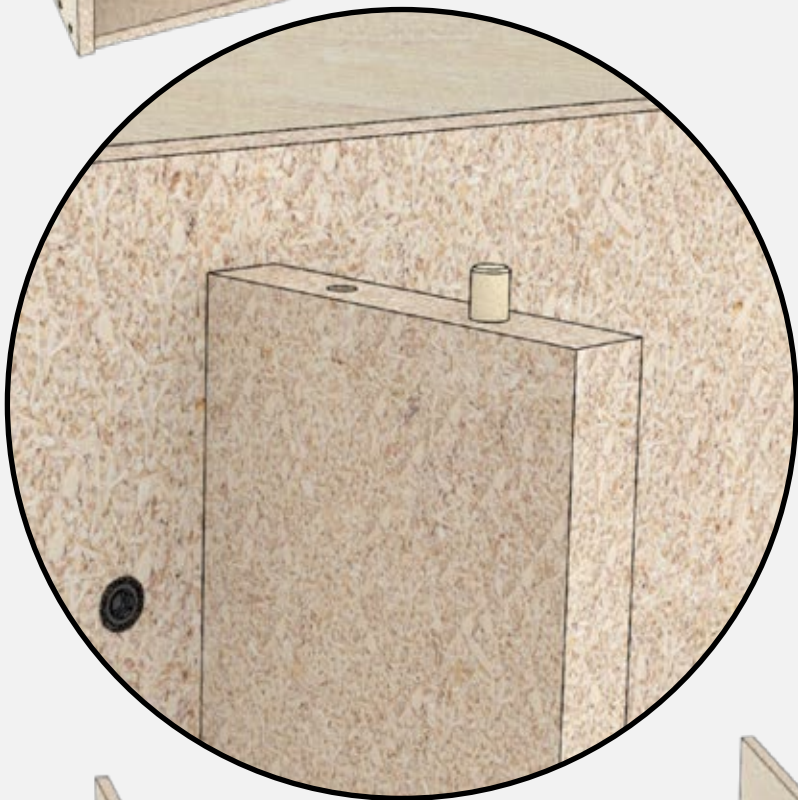
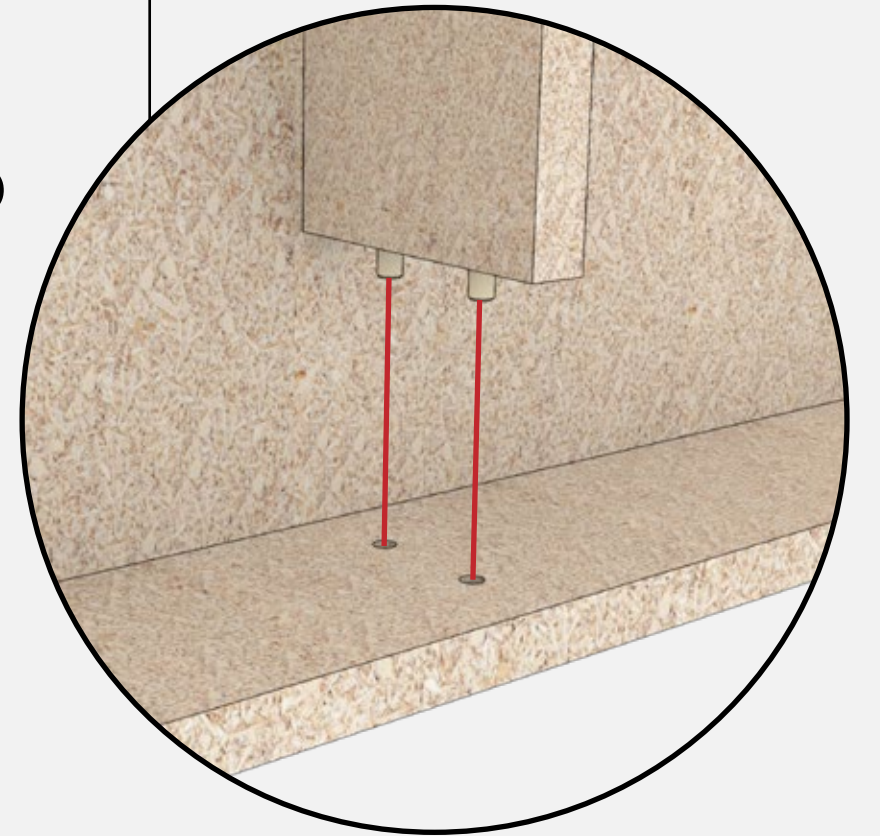

**H8**



**H9**

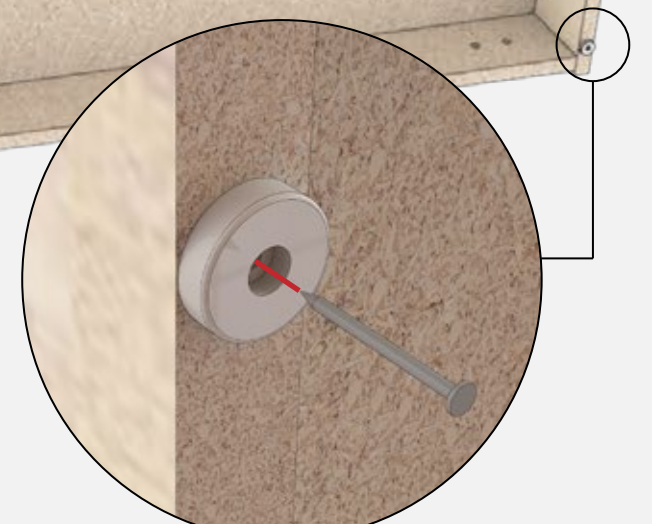
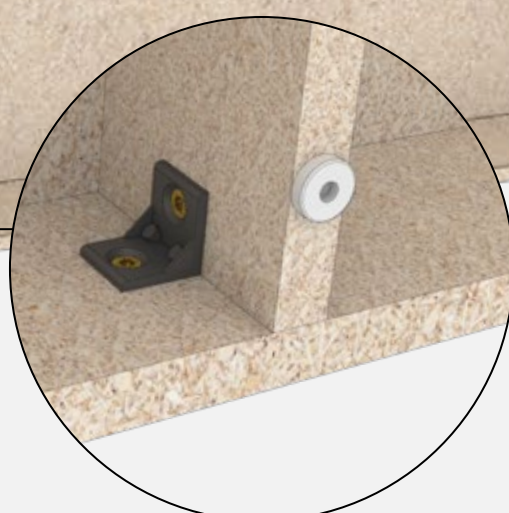

# 06

## Colocar divisorios

Vincular divisorios y estantes.  
Todos se vinculan con tornillos  
Allen 6.3x50.

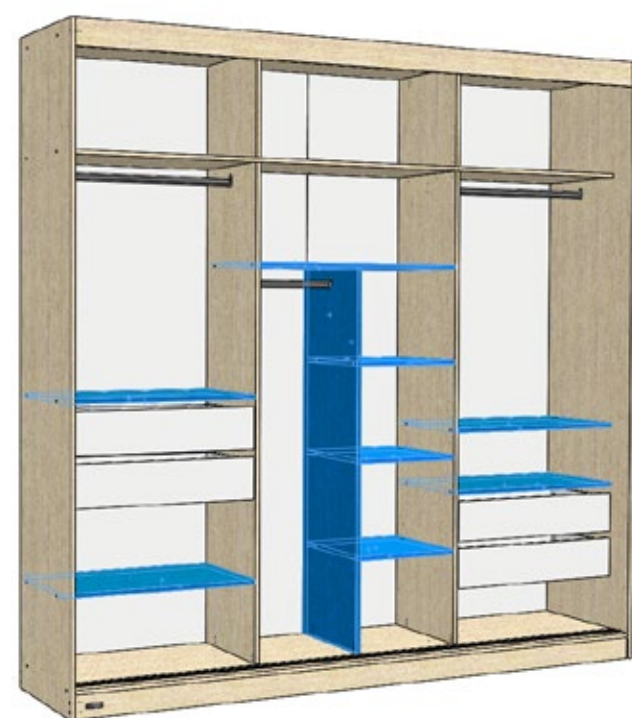

**P5**  
**Parante**  
**Nido**  
**1348x421**

**P13 Estante**  
**220**  
**770x422**

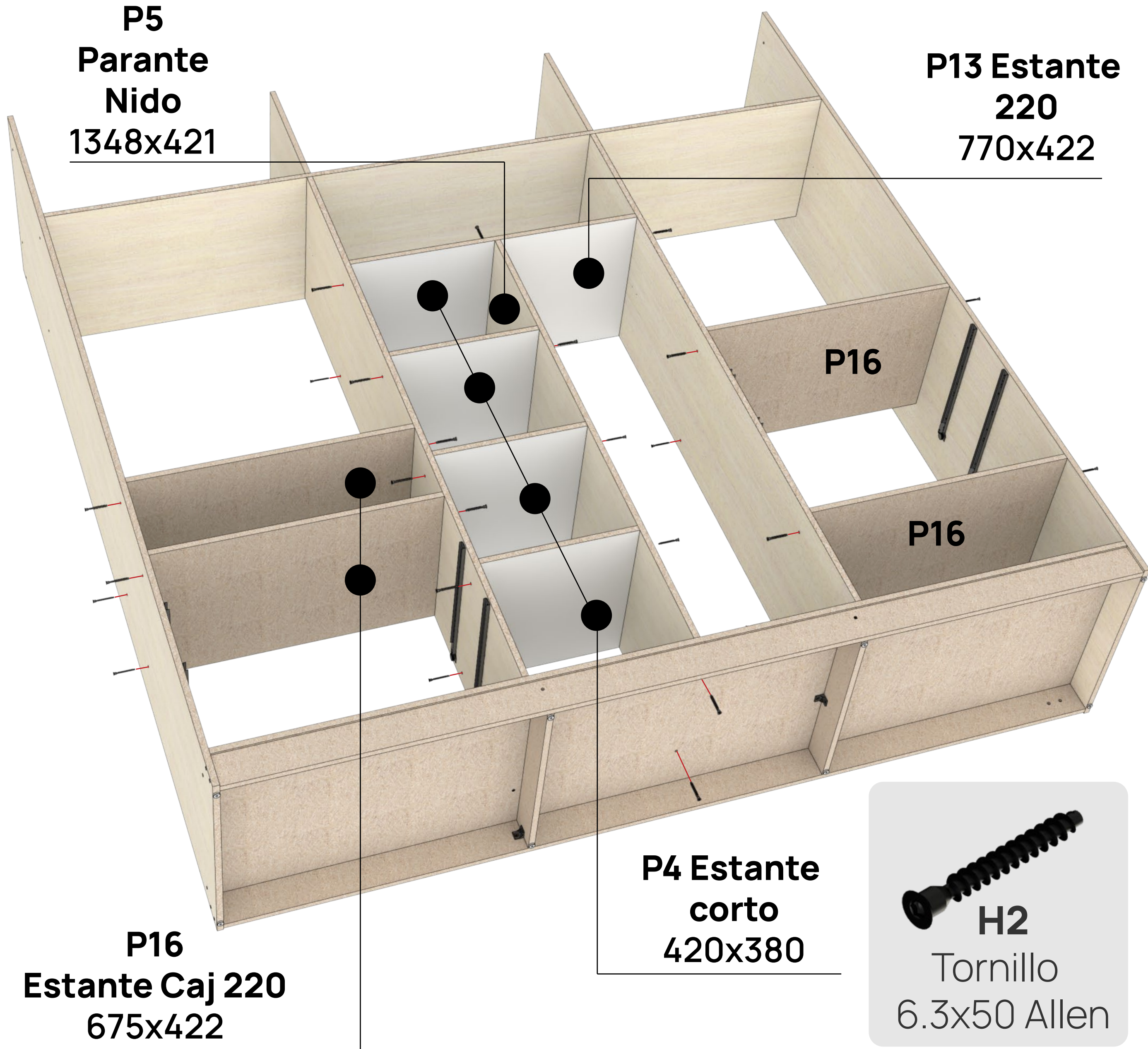

**P16**  
**Estante Caj 220**  
**675x422**

**P4 Estante**  
**corto**  
**420x380**

  
**H2**  
Tornillo  
6.3x50 Allen

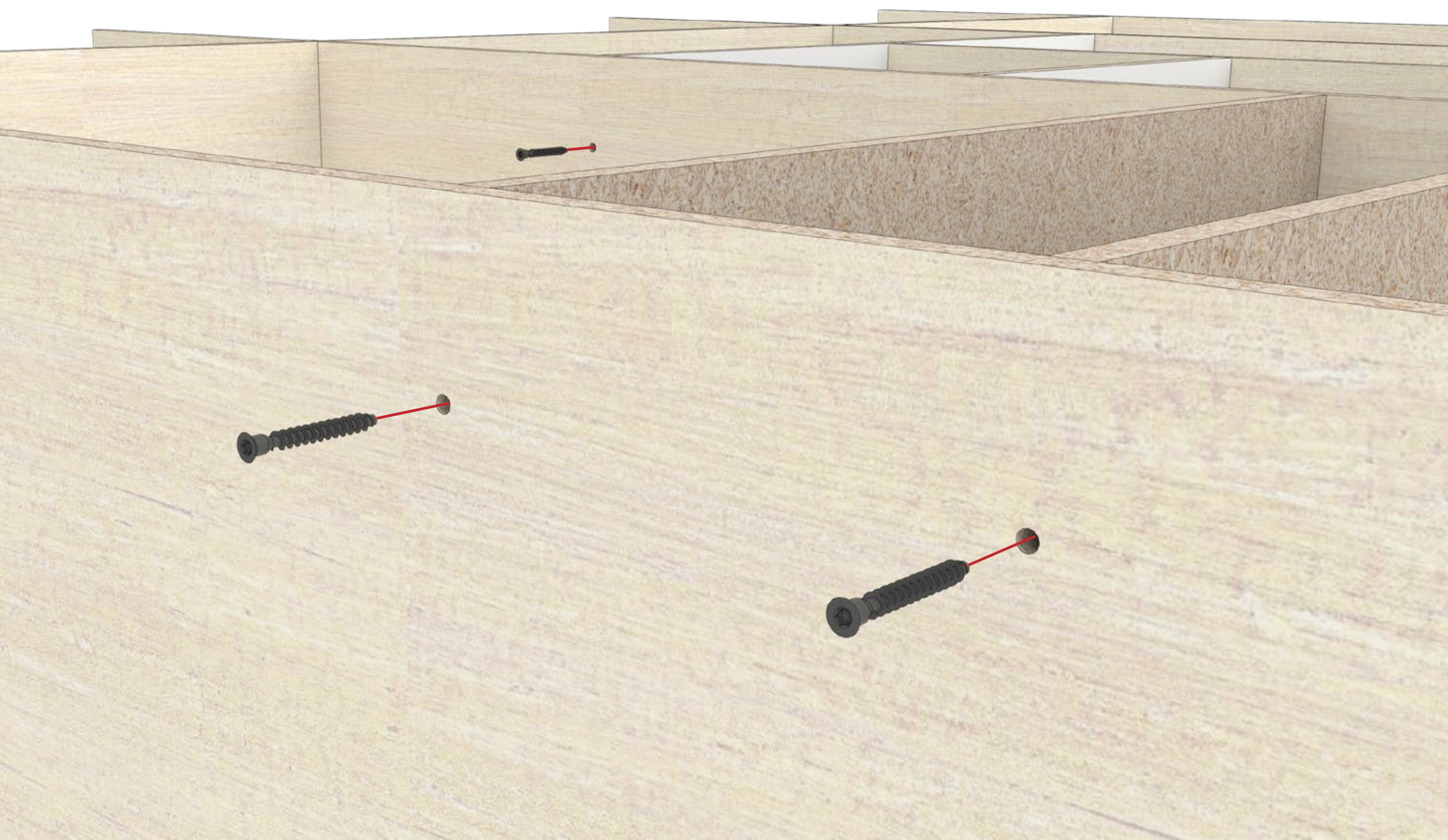

# 07

## Colocar Techo y Cenefa

Vincular techo con 4 tornillos Allen, luego vincular cenefa con 2 tornillos Allen y 3 trapecios.



H2

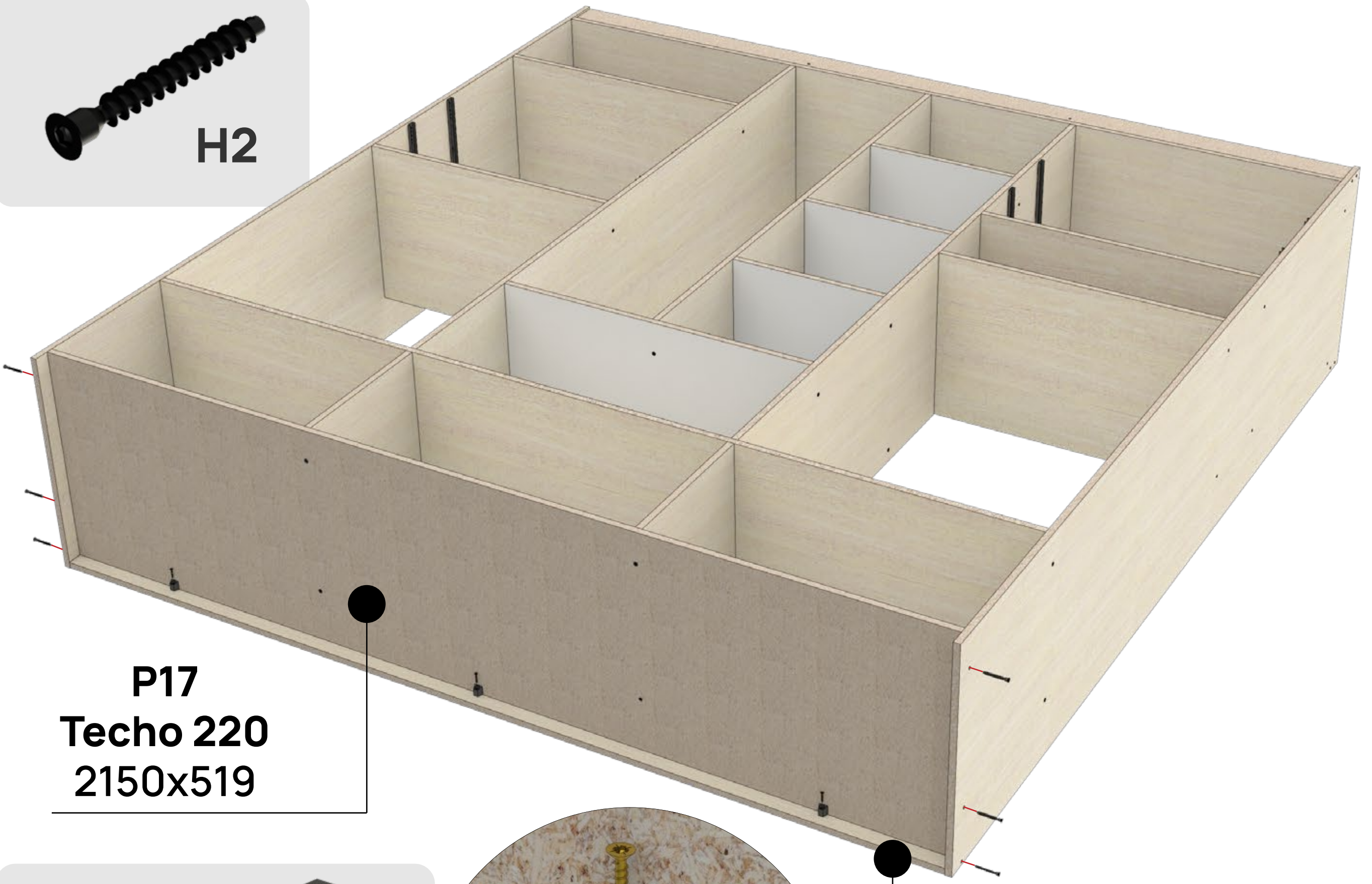

**P17**  
Techo 220  
2150x519



H11

Tornillo  
4x25



H12

Trapecio

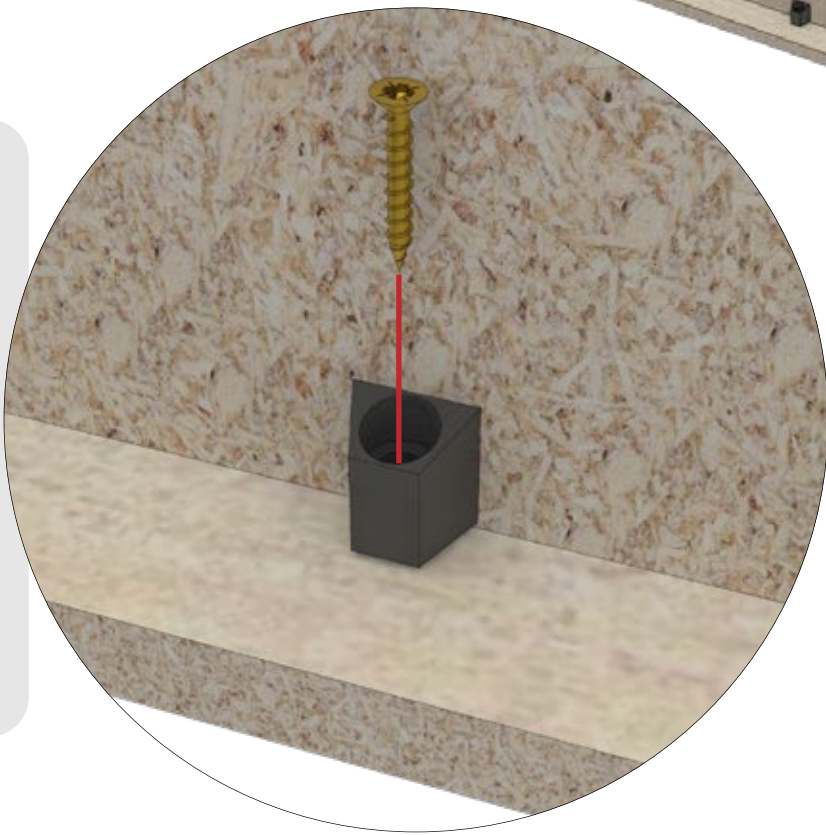

**P23 Cenefa 220**  
2150x90



# 08

## Clavar fondo

Corroborar que el mueble esté colocado en escuadra a 90° y clavar 6 fondos. Clavos cada 13 cm aprox.

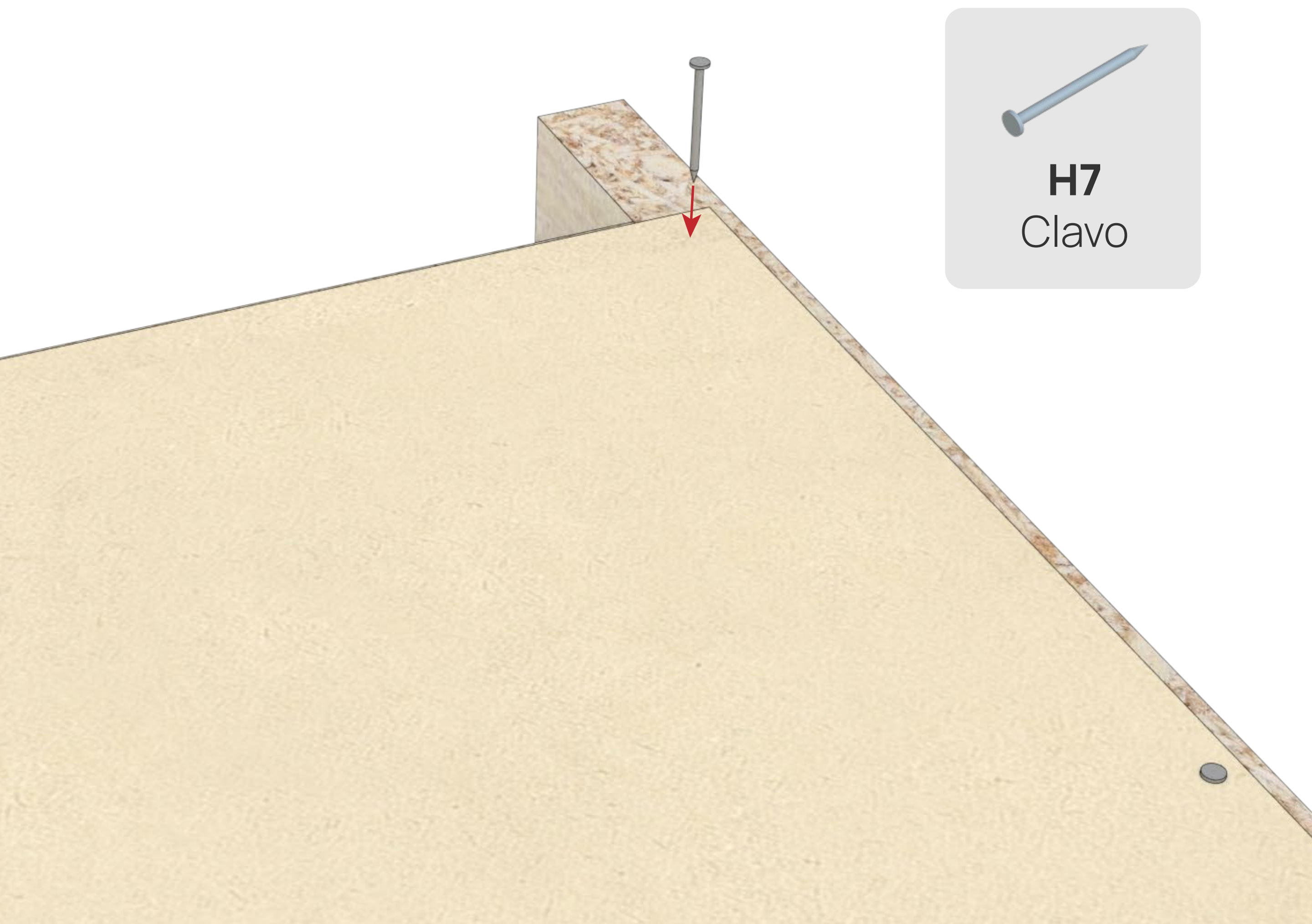
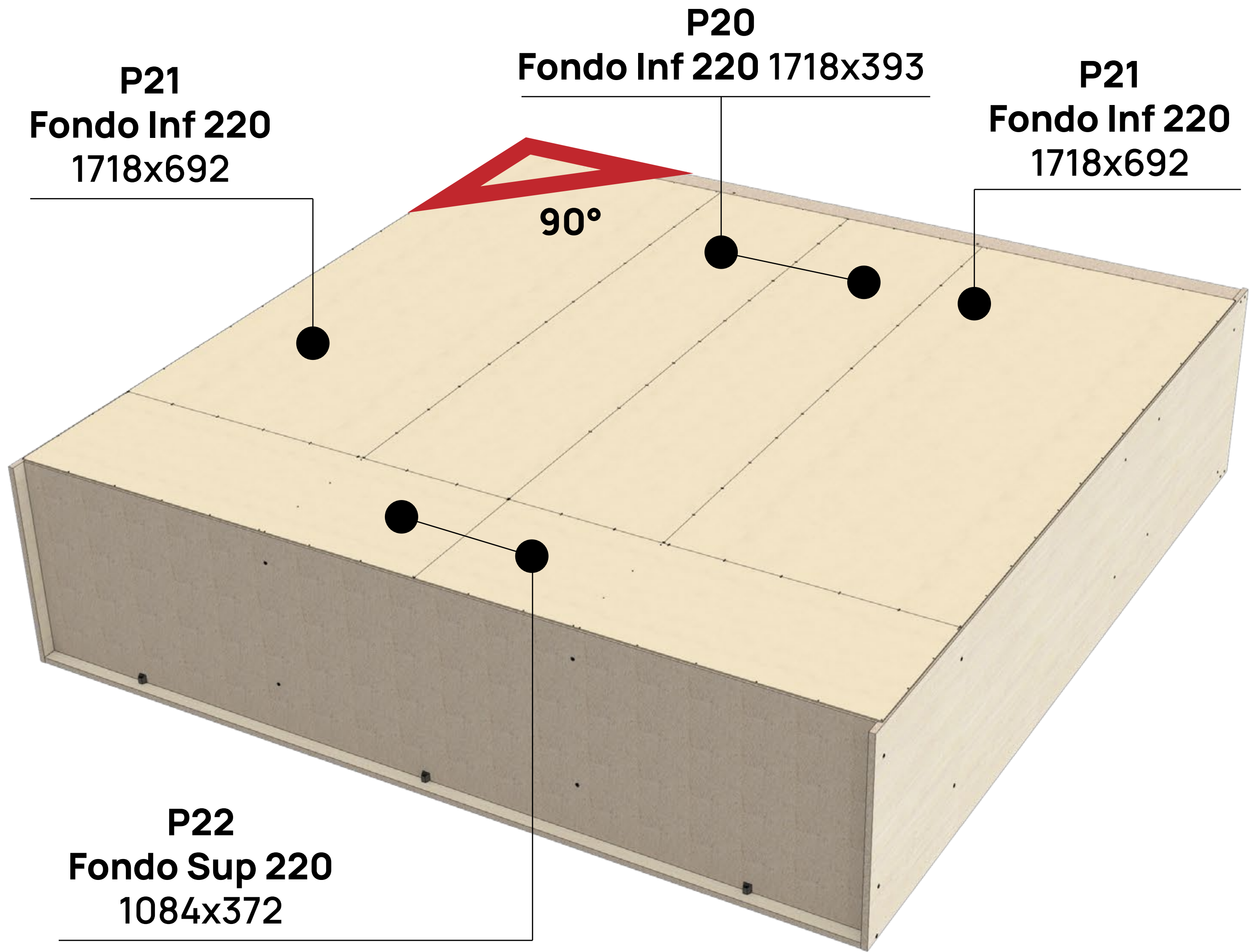
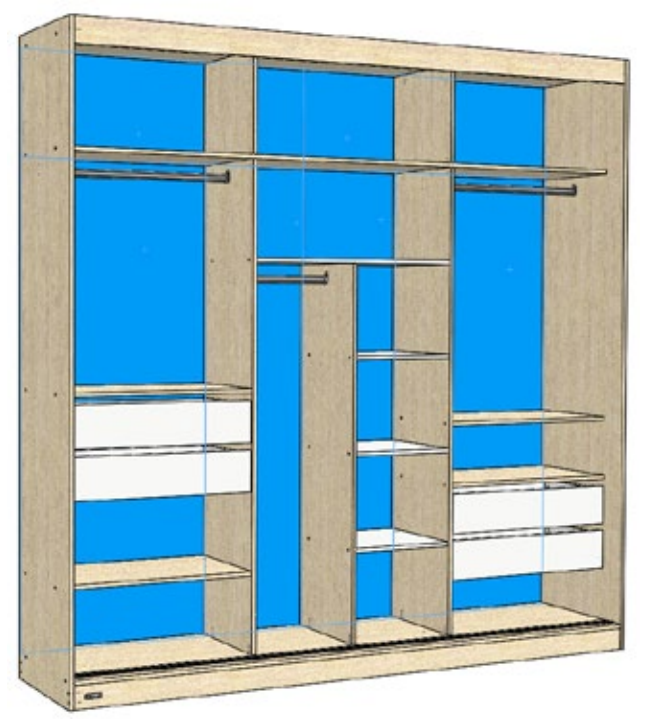

# 09

## Costado de cajón

Colocar a presión **cazoletas**,  
y **tarugos**.

Encolar perforaciones antes  
de colocar tarugos.

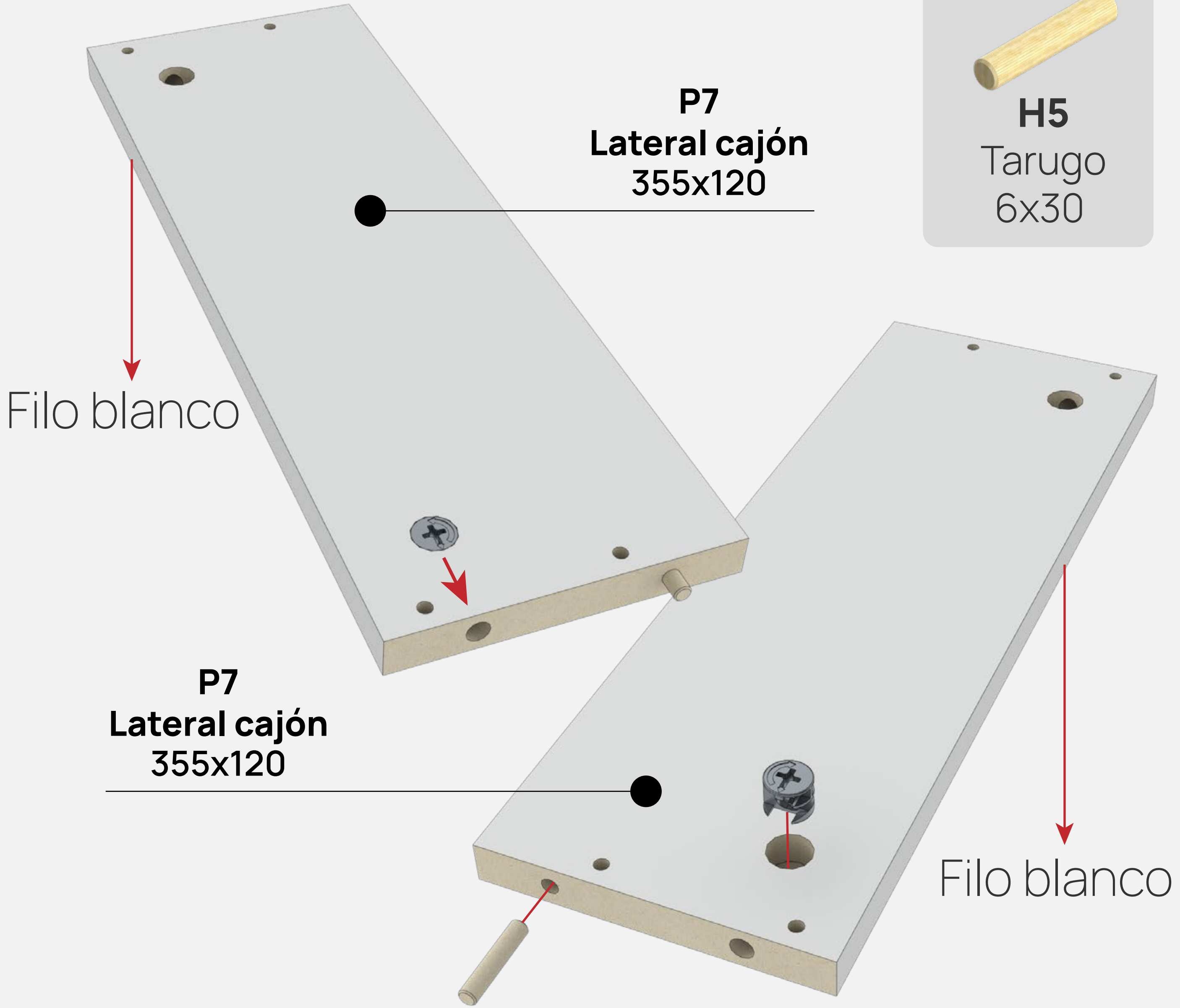
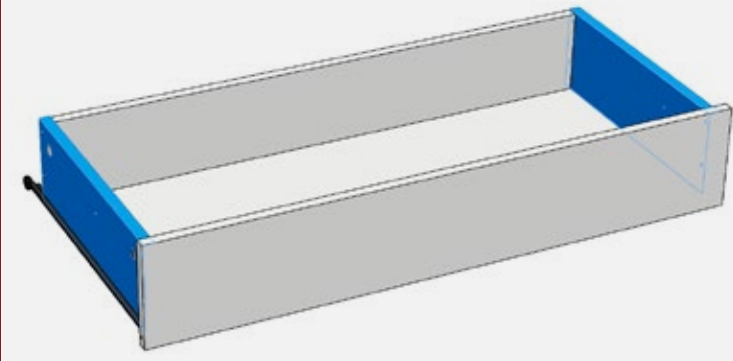

**H5**  
Tarugo  
6x30

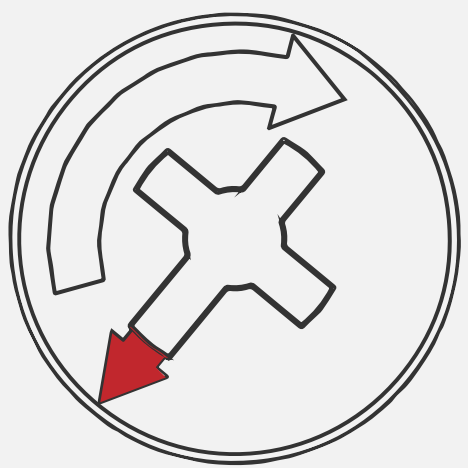

Colocar **cazoleta minifix** con la flecha  
apuntando hacia la perforación.

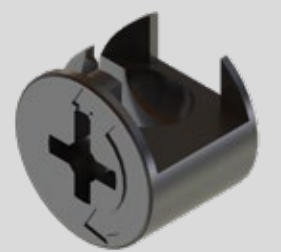
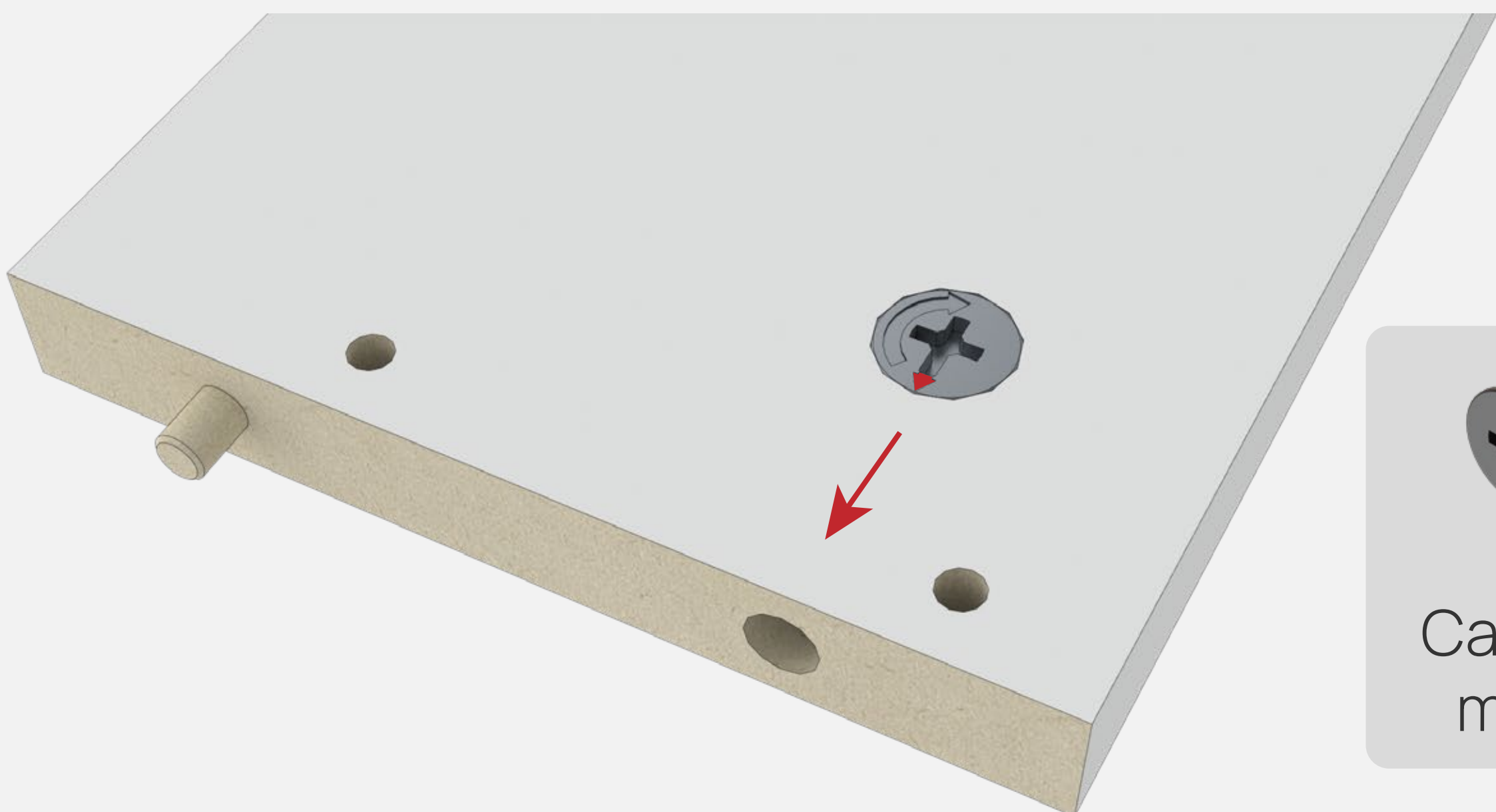

**H14**  
Cazoleta  
minifix

# 10

## Frentes de cajones

Enroscar 2 pernos minifix,  
hasta que hagan tope!

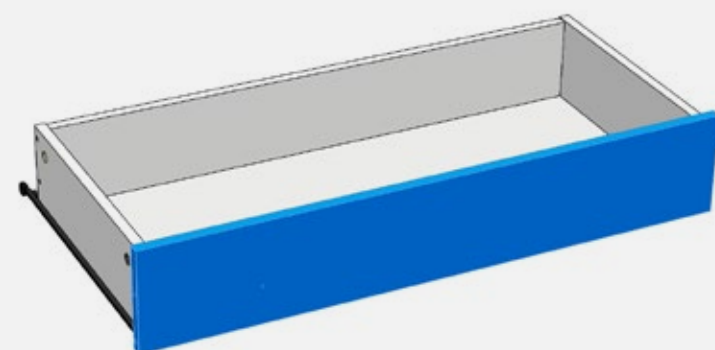

P8  
Frente cajón

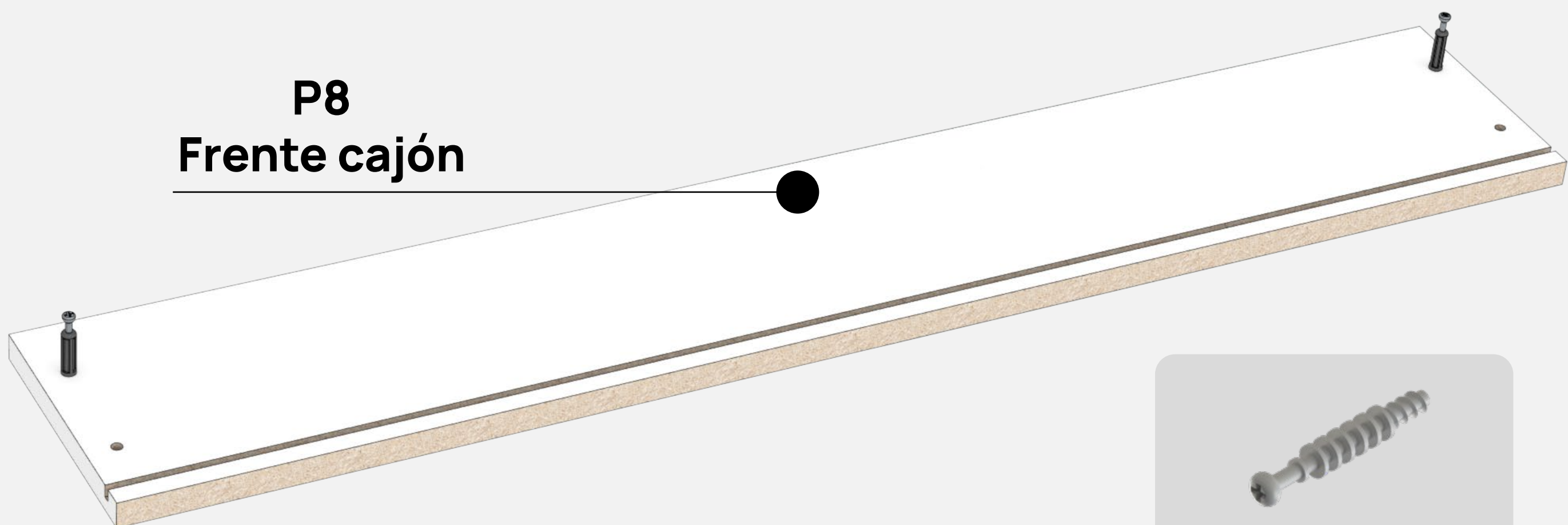

H15  
Perno  
minifix



Ajustar hasta  
que haga **tope!**

# 11

## Armar cajones

Unir laterales de cajón con frente y contrafrente.  
Mantener cajón escuadrado a 90°.

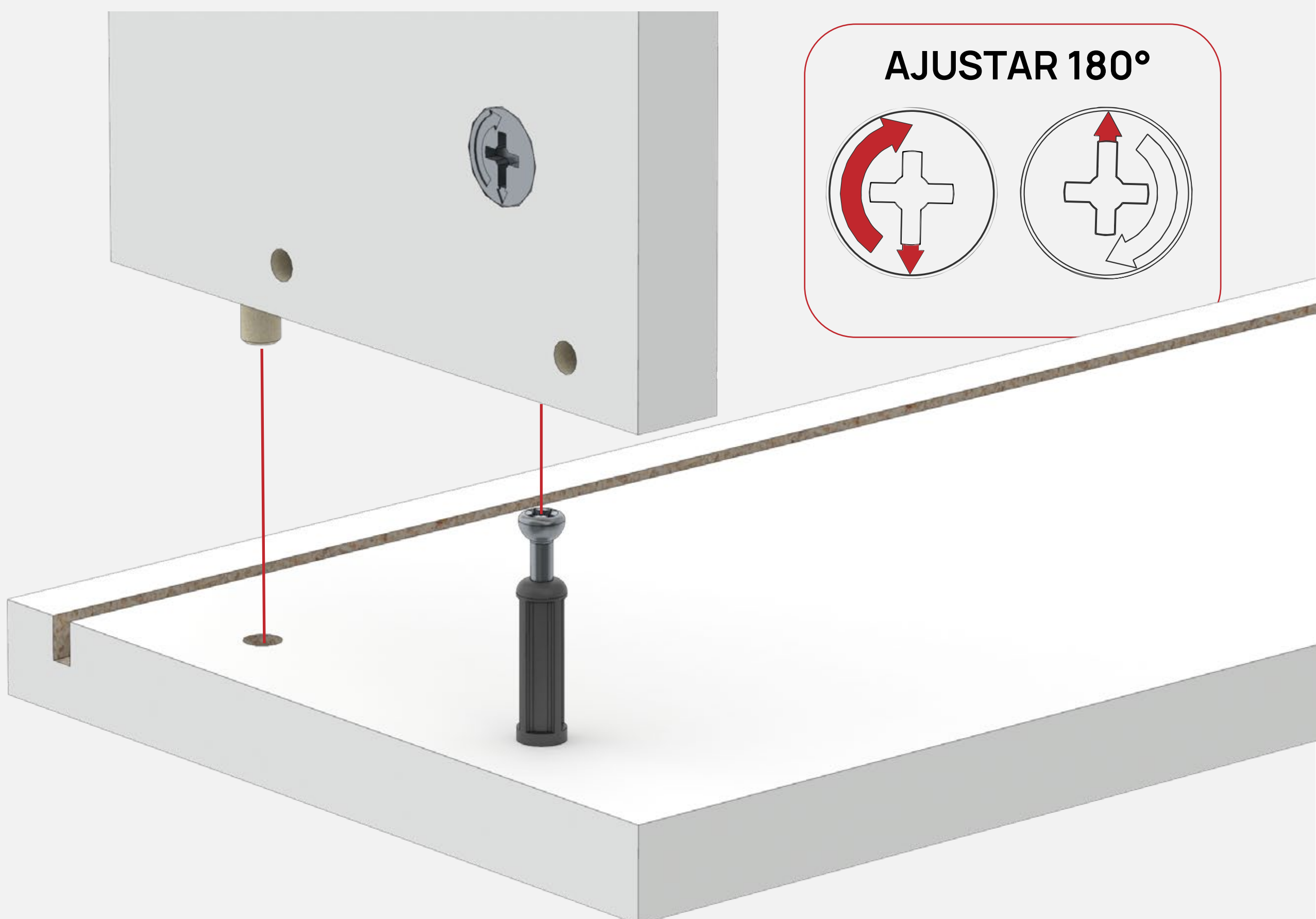
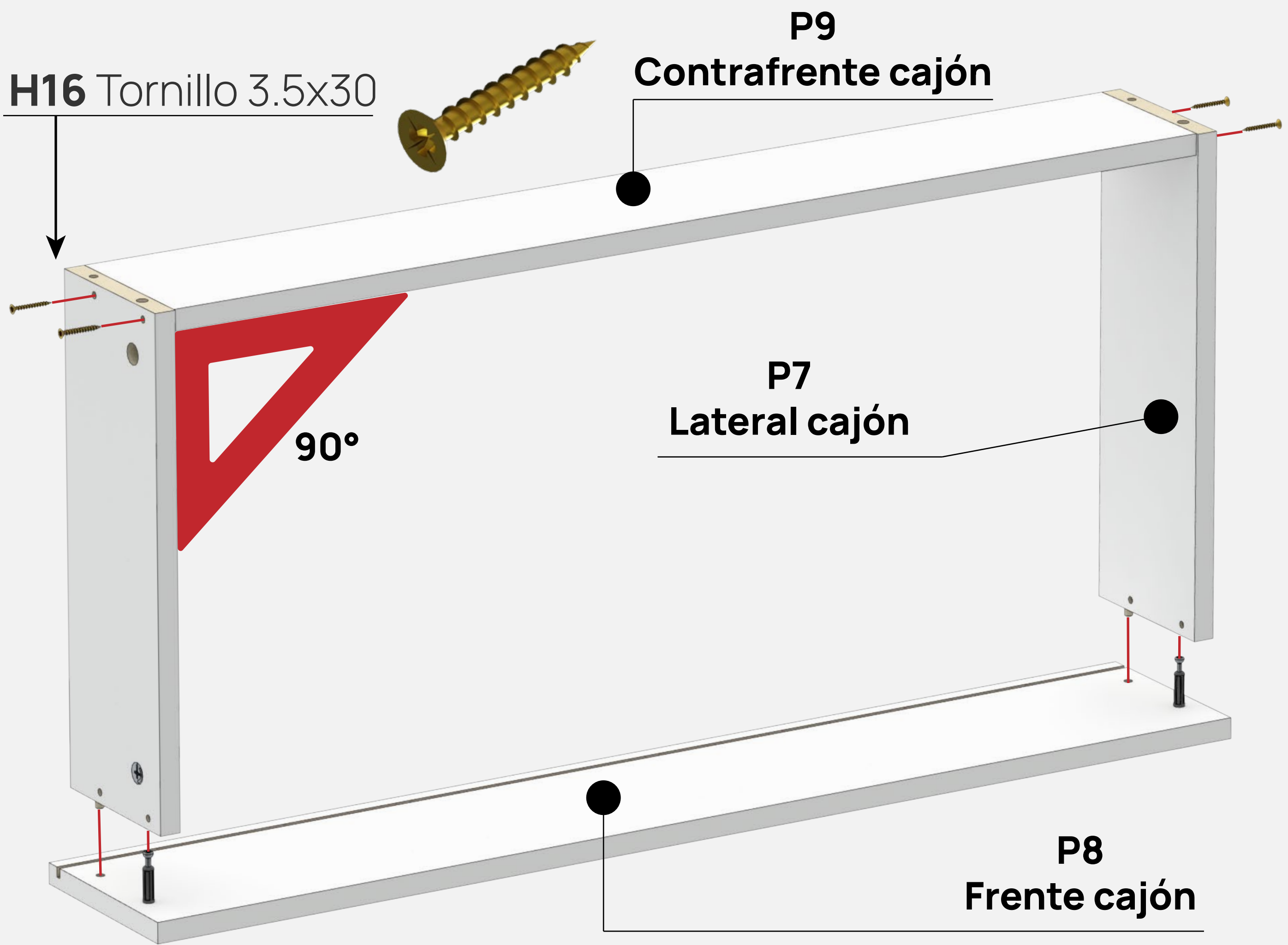

# 12

## Colocar fondo de cajón

Clavar fondo de cajón. Es muy importante verificar escuadra a 90°. Clavos cada 12 cm. aprox

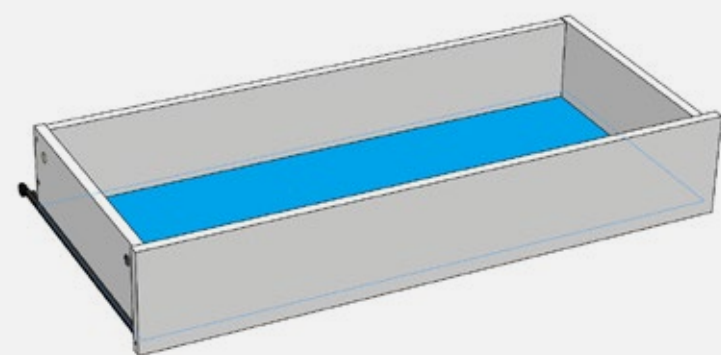

P6 Fondo  
Cajón 220  
647x362

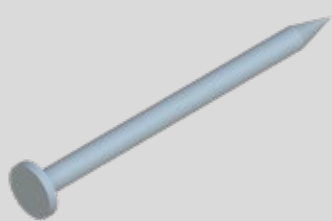
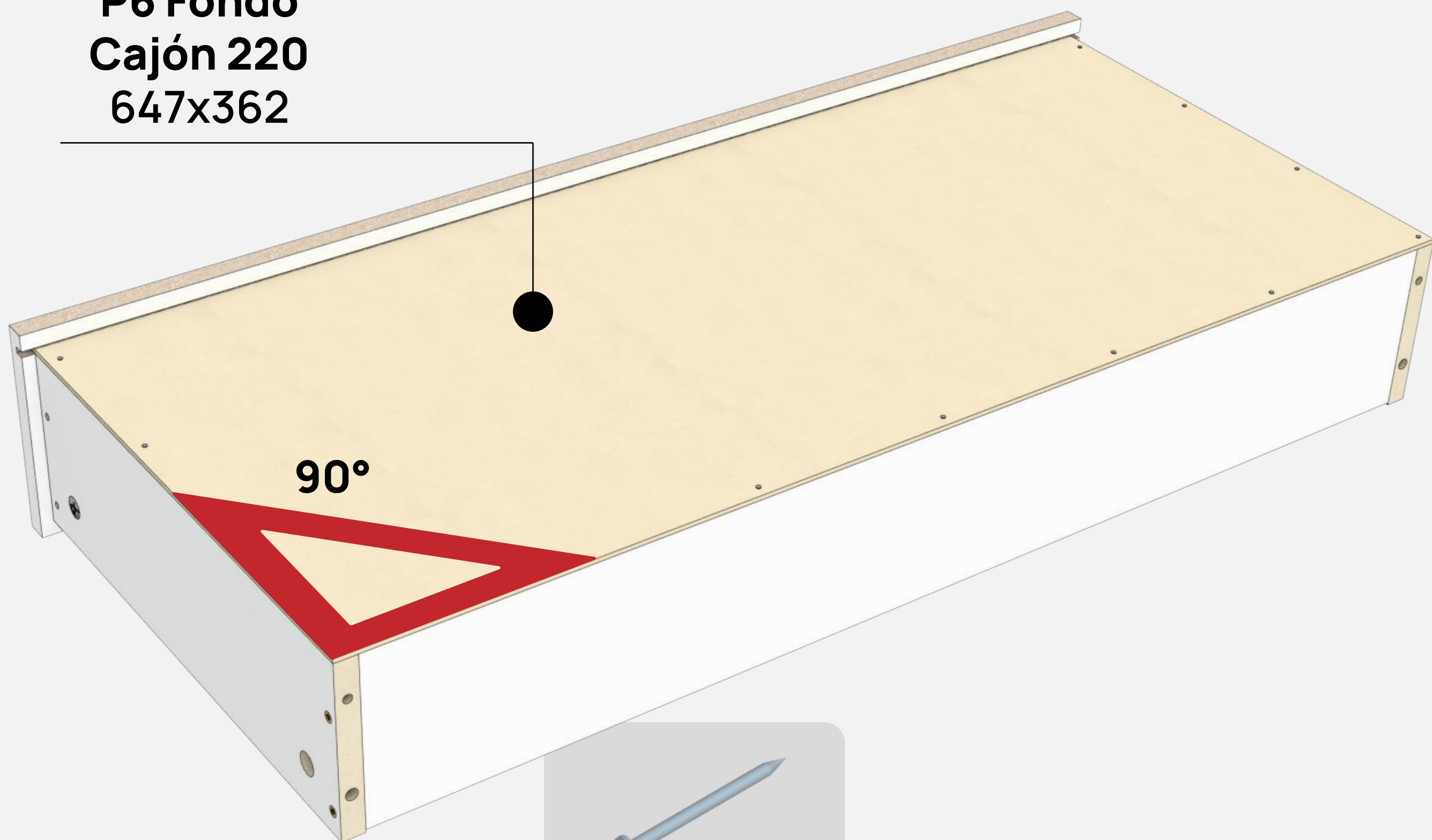

H7  
Clavo

**ENCASTRAR EN RANURA**

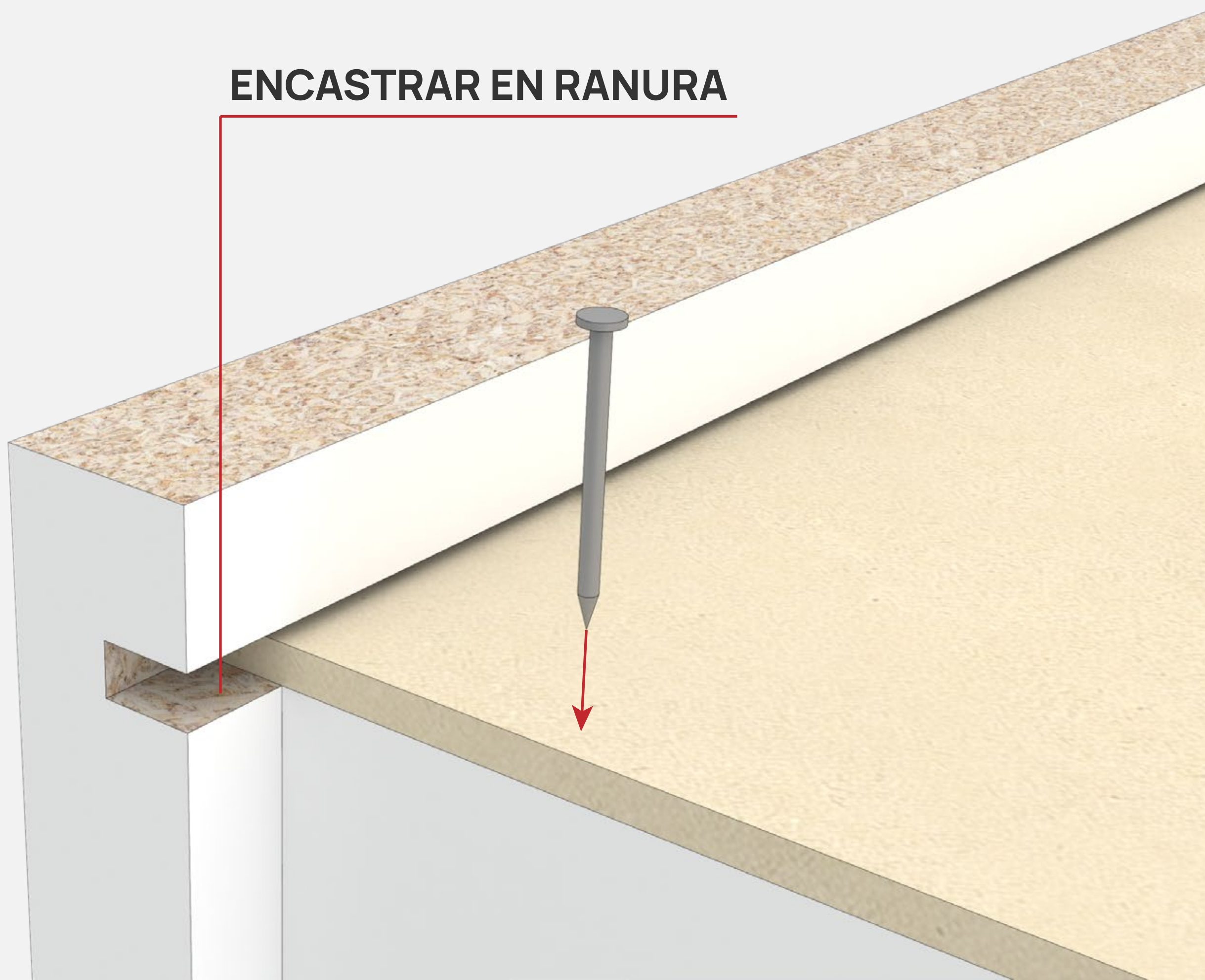

# 13

## Colocar correderas

Colocar correderas en Cajones.  
Cada corredera se vincula  
con **2 tornillos 3.5x15.**



**P6**  
Fondo  
Cajón  
813x362

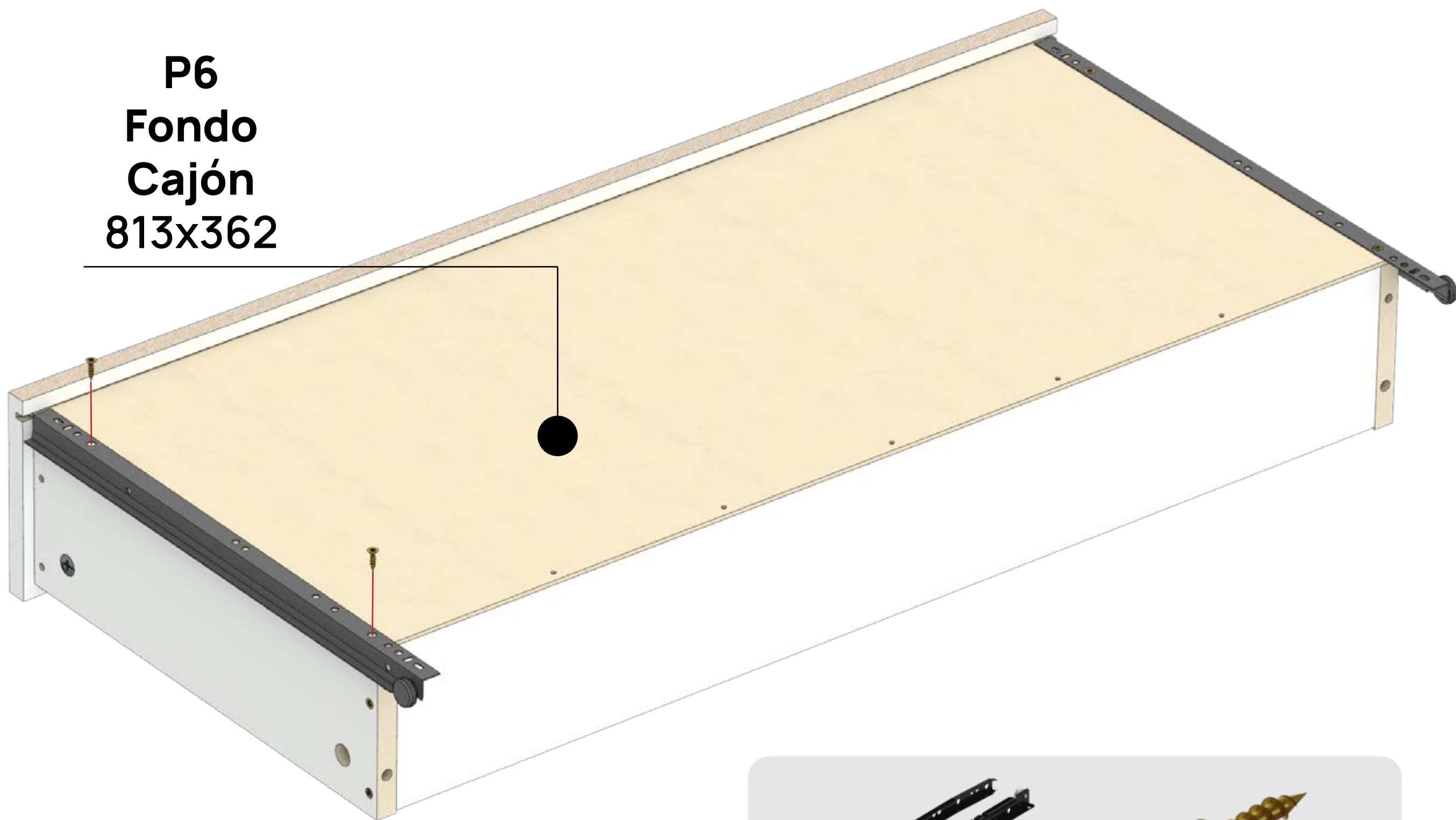

**H3**  
Corredera  
Z 400



**H8**  
Tornillo  
3.5x15

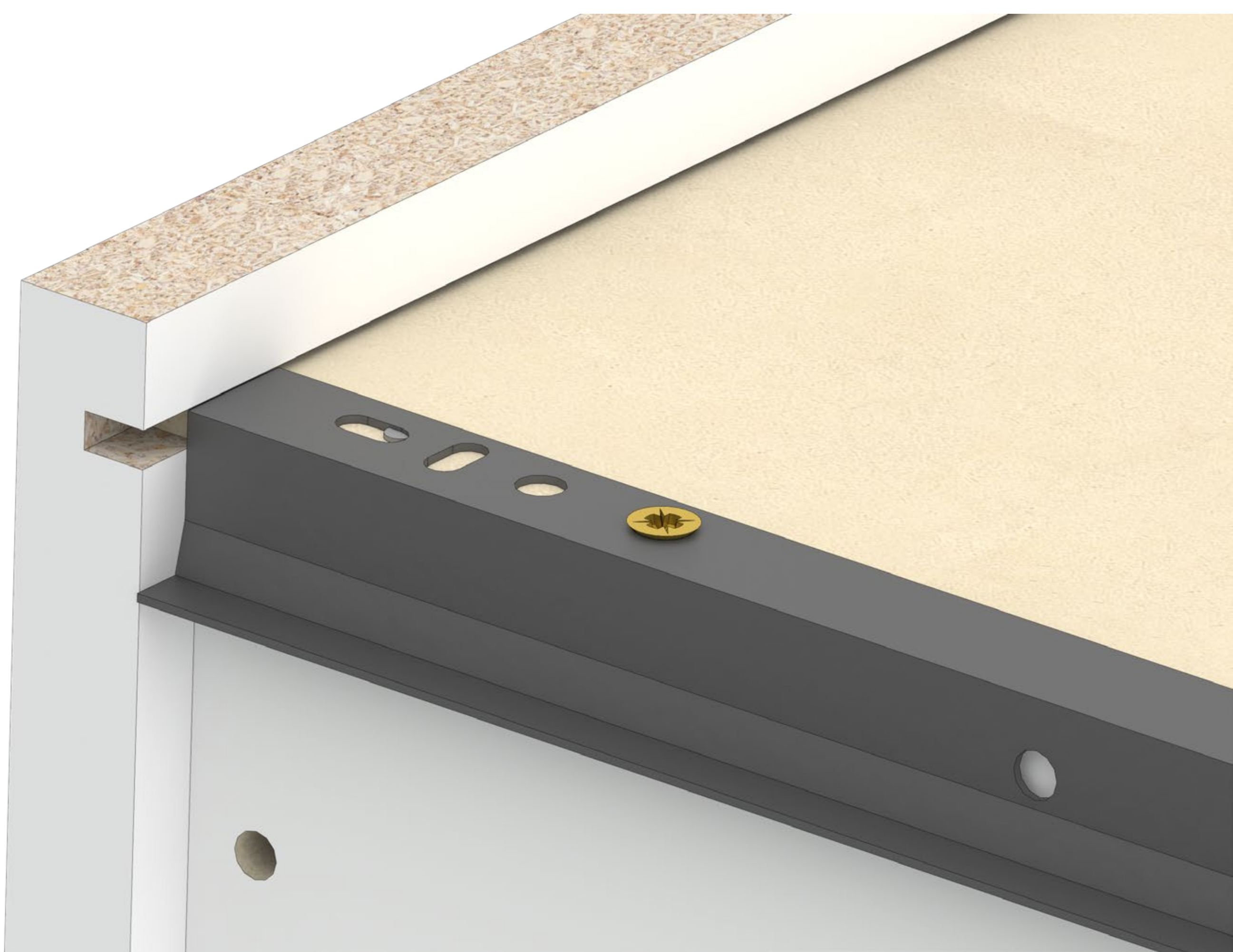

# 14

## Colocar Aluminios

La guía superior se coloca oculta detrás de la cenefa. Los tornillos autoperf. actúan como mecha.

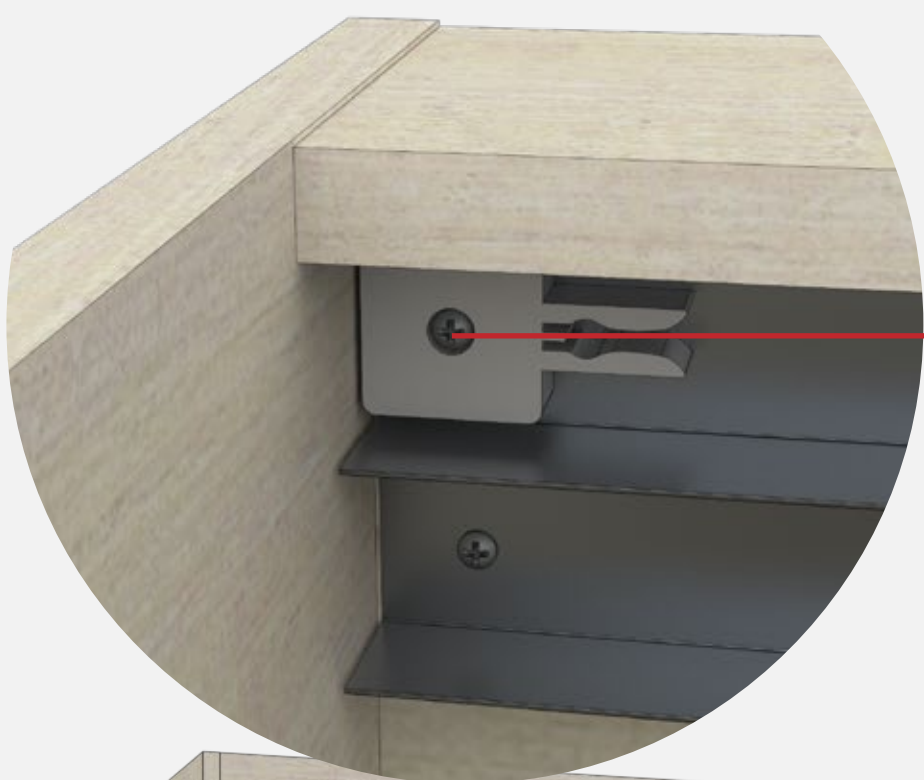
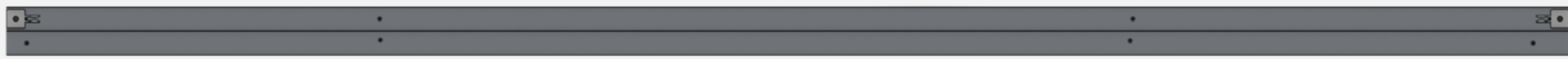

**H18** Kit Rueda + Freno

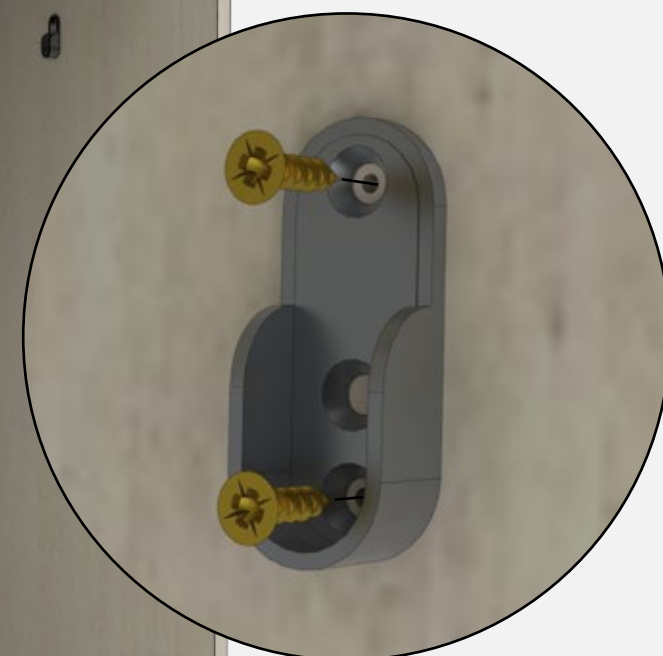

**H19** Soporte Lat. barral



**H17** Tornillo Autoperf.



**H17** Tornillo Autoperf.

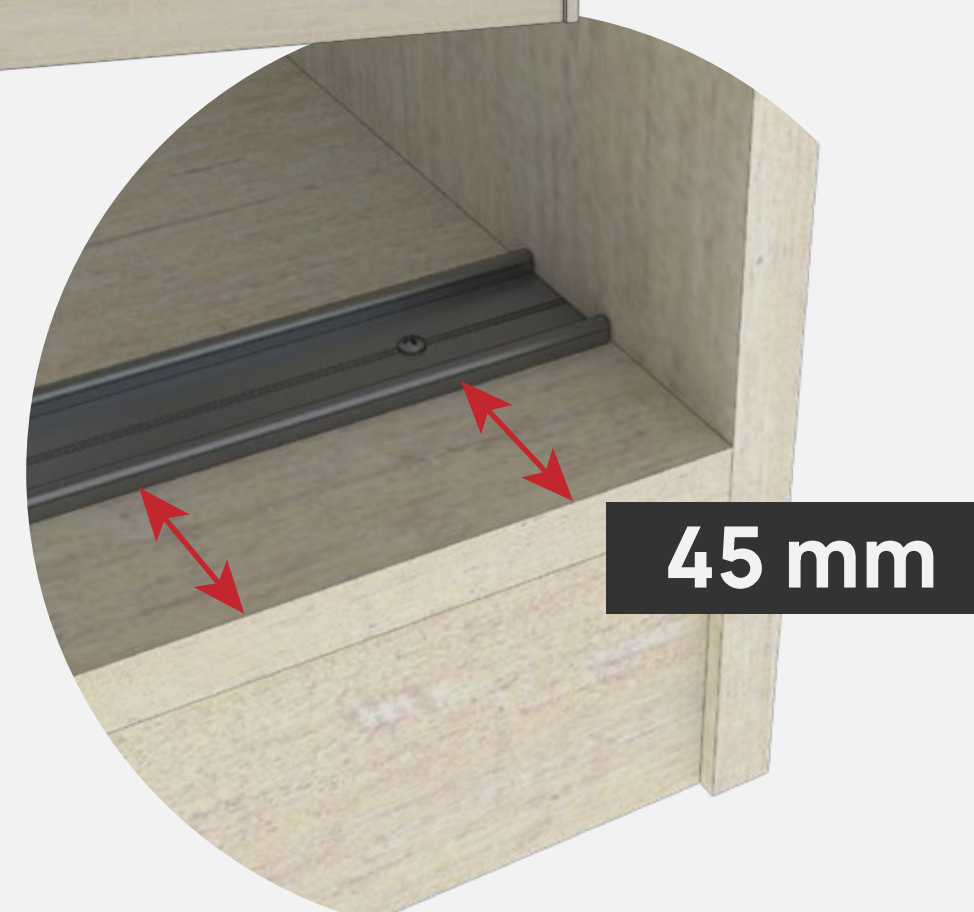

45 mm

H17

H17

H17

H17

# 15

## Cajones y barrales

Deslizar cajones como indica el gráfico.

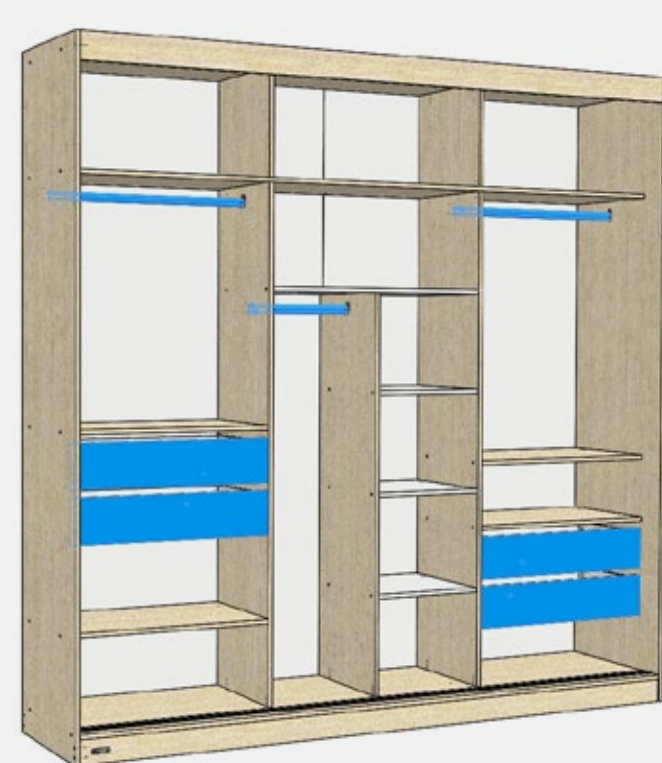

Barral de colgado - 668



Barral de colgado - 368

Corredera de cajón

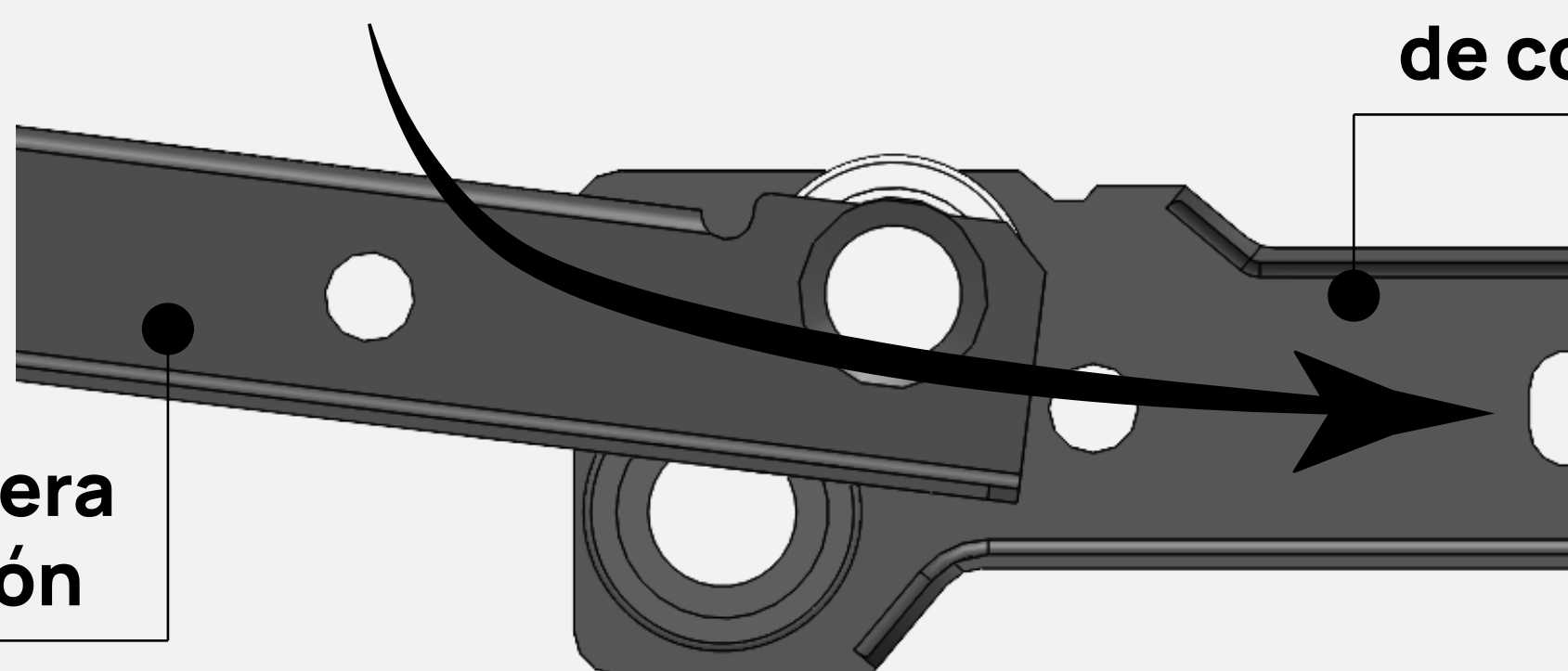

Corredera de costado

# 16

## Armar puertas

Colocar ruedas superiores,  
ruedas inferiores.

Encastrar manijas Athena

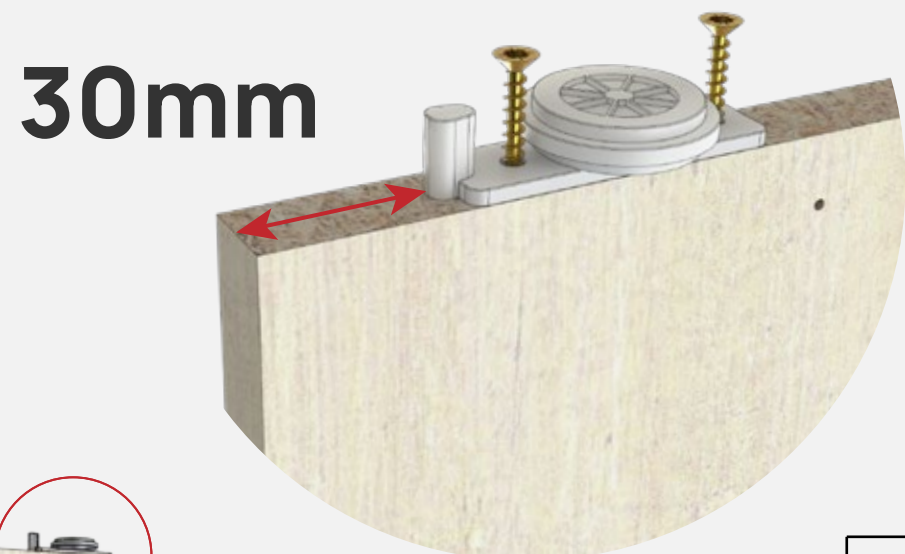
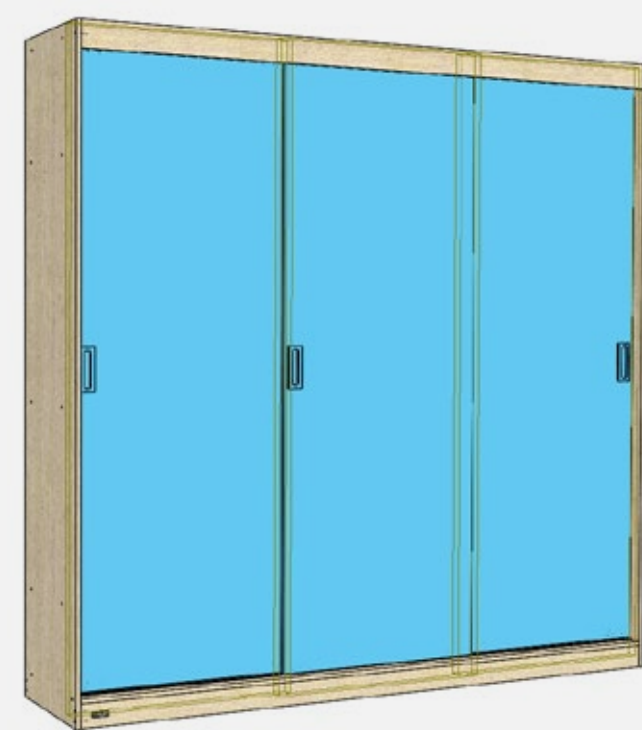

P19  
Puerta BR 180  
2043x883



H21  
Manija  
Athena

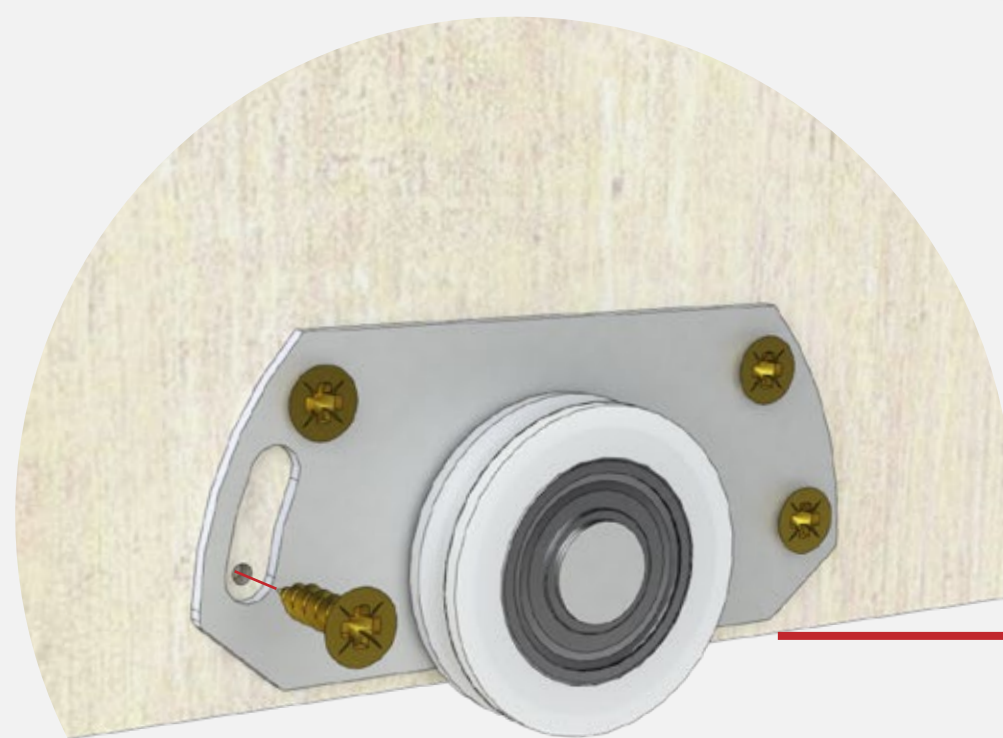

Dejar 2 mm  
entre la rueda  
y el canto inferior

# 17

## Colgar puertas

Colgar puertas como indica la flecha.



**P19**  
**Puerta BR 180**  
**2043x883**

**Apoyar 2 ruedas sobre riel frontal  
y 2 en el posterior de la guía de aluminio**

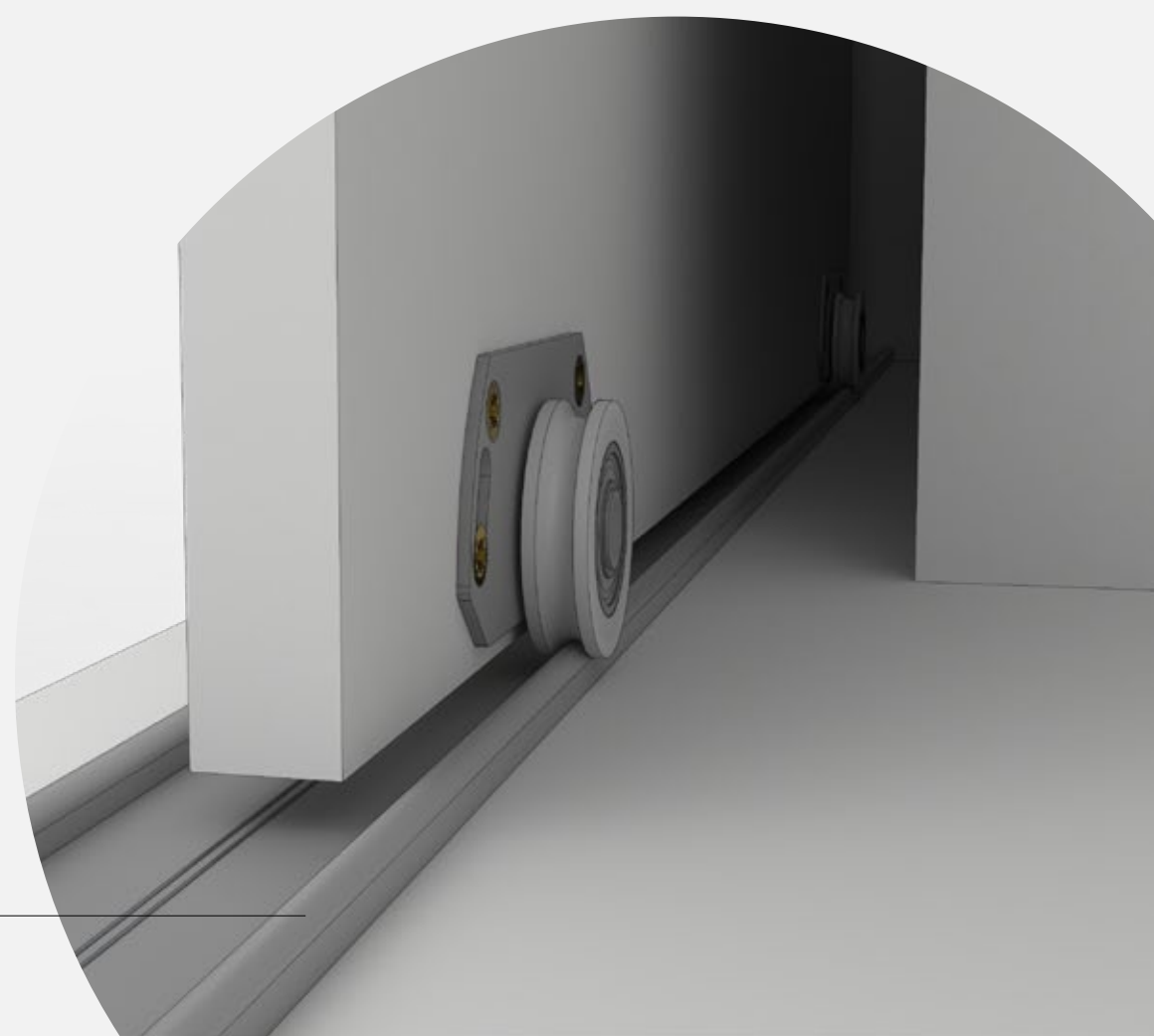

**Terminaste!**  
Disfrutá tu Placard Velvet



**#ExperienciaMosconi**