



LOTE 1

Seguí los pasos y armá tu Placard **Geo 3 puertas**



Abrí la caja y posicioná
las piezas en el piso.

CAJA 1
DE 2

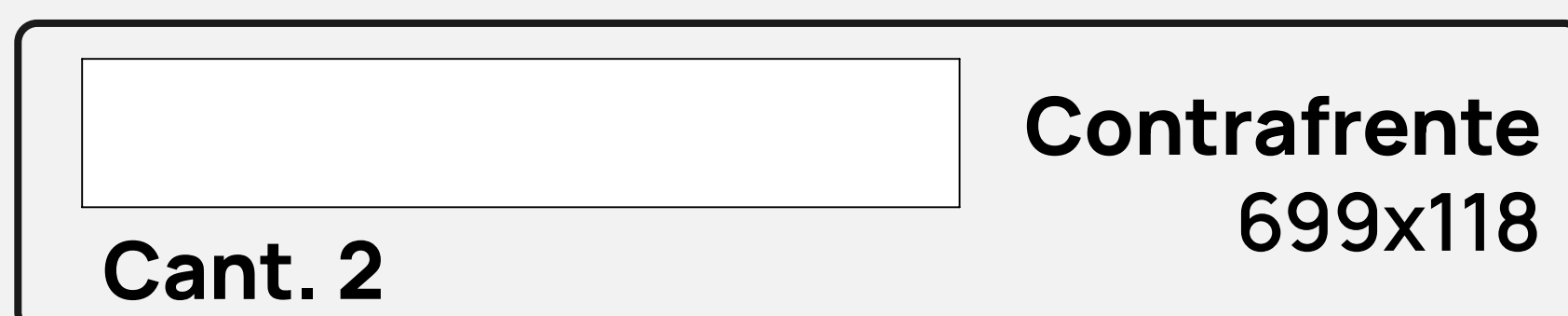
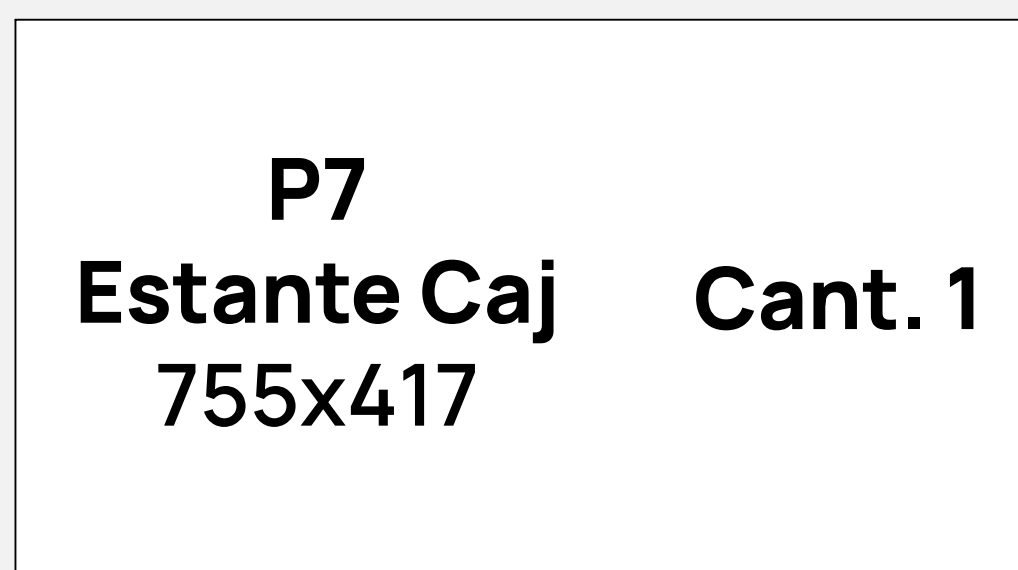
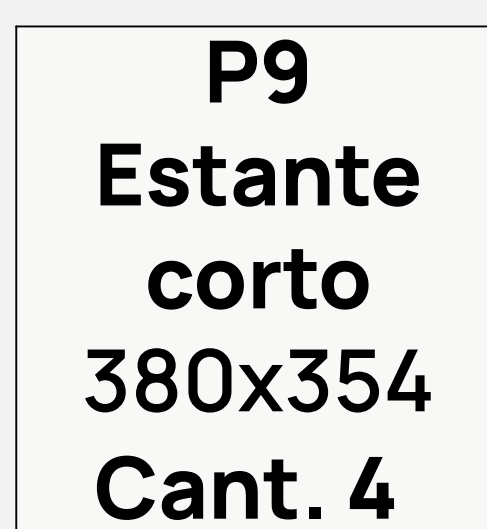
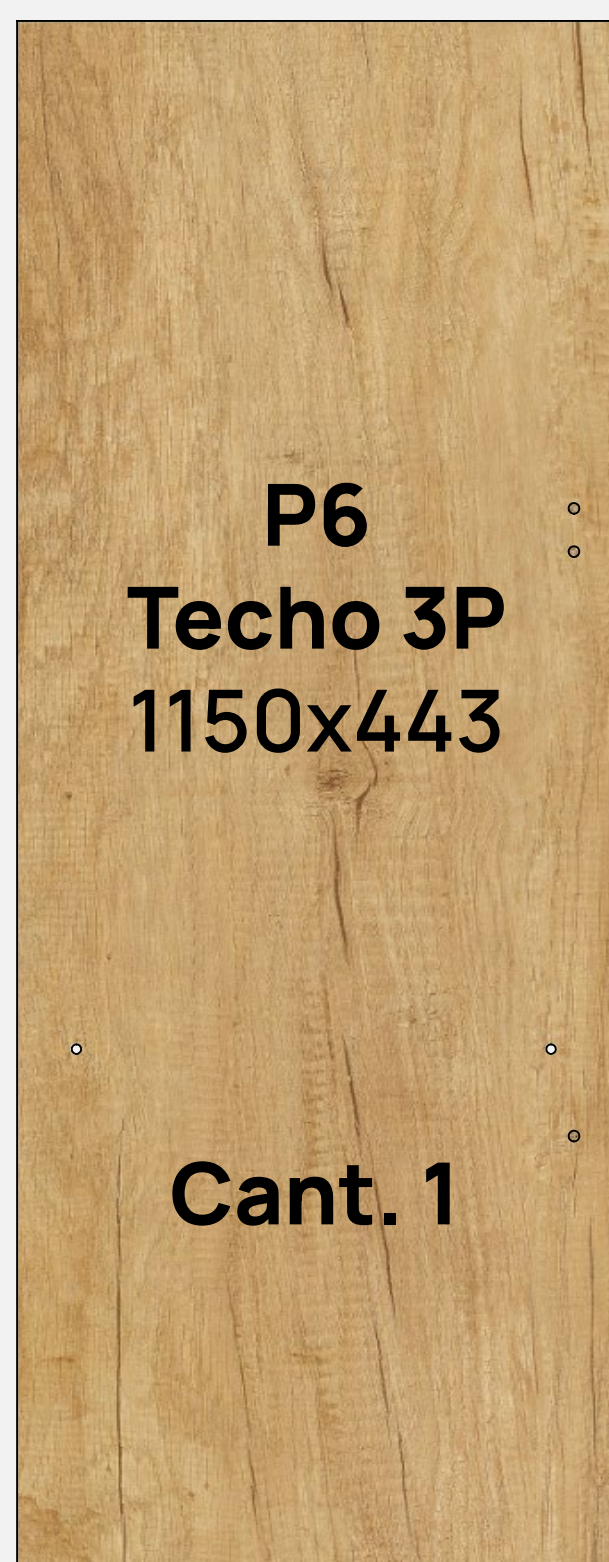
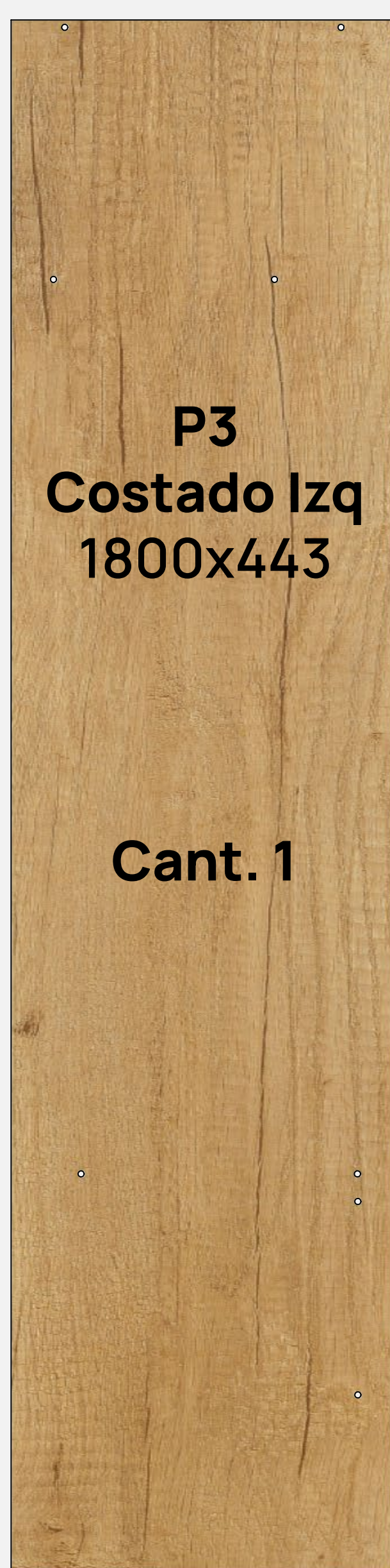
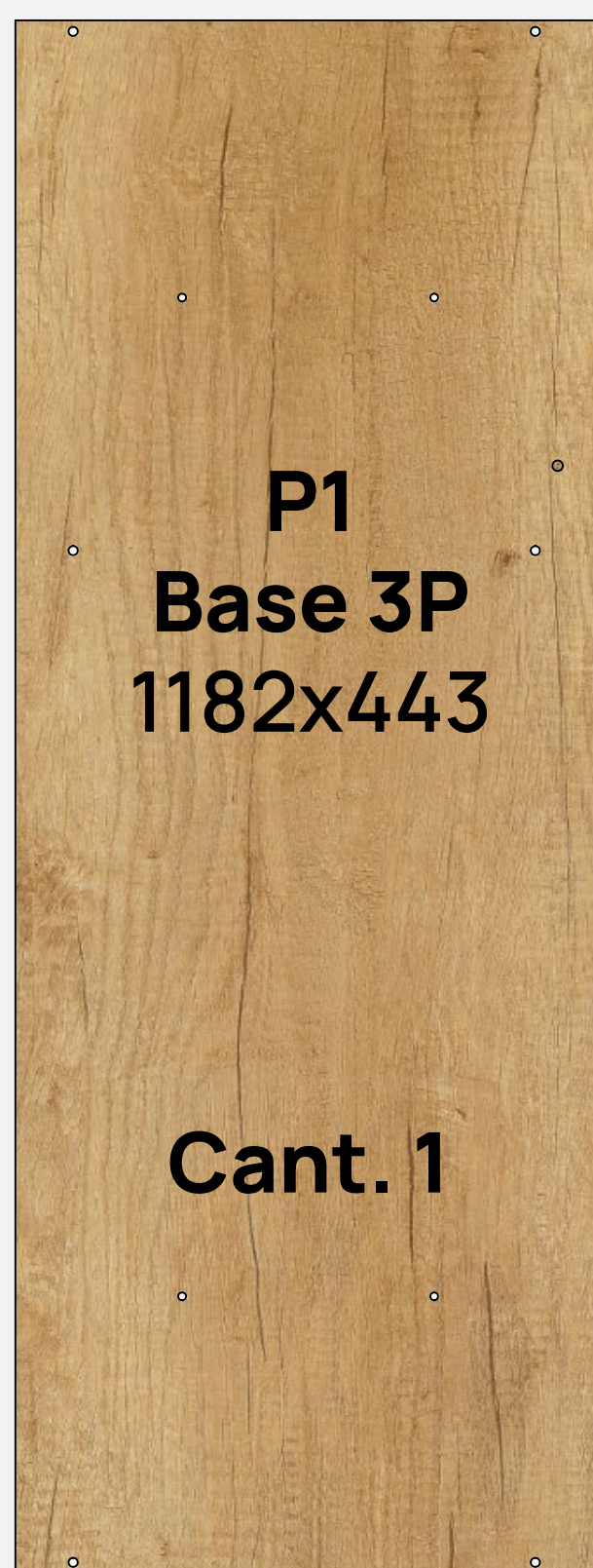
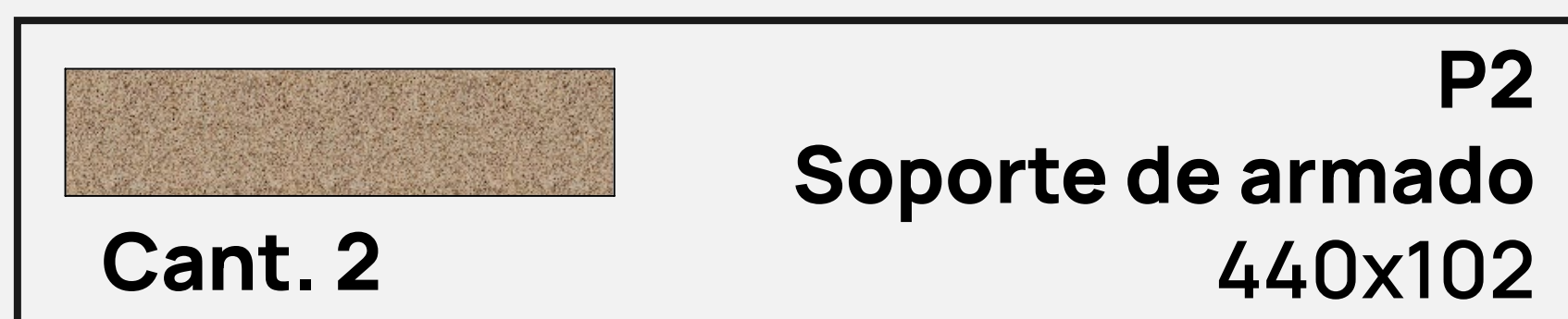

Abrí la caja y posicioná
las piezas en el piso.

CAJA 2
DE 2

P8
Estante
largo
755x354

Cant. 1



Cant. 2

P11
Frente de cajón
748x189



Cant. 2

Puntera 3P
392x67

P13
Puerta
corta
1327x372

Cant. 2

P14
Puerta
larga
1775x372

Cant. 1

Fondo
cajón
727x352

Cant. 2

Fondo
PL
1804x385

Cant. 2

Fondo
PL 3P
1804x397

Cant. 1

Herrajes



H1
Tornillo
6.3x50 Allen

40 ud.



H2
Tornillo
3.5x15

72 ud.



H3
Pata
plást. cuad.
100mm

6 ud.



H4
Corredera
Z 400

2 ud.



H5
Tornillo
variante 6x8

8 ud.



H6
Clavo

1 bolsa

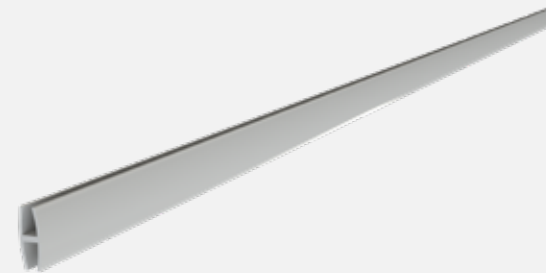

H7
Varilla H
1313

1 ud.



H8
Soporte
estante

4 ud.



H9
Tapón
6 mm

2 ud.



H10
Soporte
Lat. barral

2 ud.



H11
Perno
minifix

4 ud.



H12
Cazoleta
minifix

4 ud.

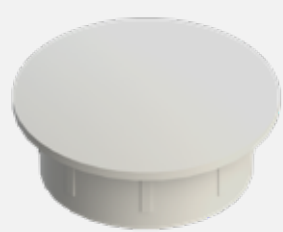

H13
Tapa plástica
15 mm

4 ud.



H14
Tarugo
6x30

8 ud.

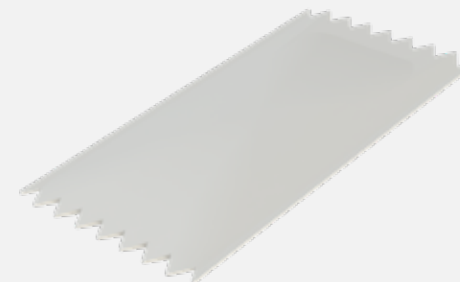

H15
Sachet de
Cola 10 grs.

1 ud.



H16
Bisagra codo
17

9 ud.



H17
Tirador Elipse
96 mm

3 ud.



H18
Tornillo 3.5x25
plateado

6 ud.



H19
Tornillo
3.5x30

8 ud.



H20
Barral
de colgado

1 ud.

¿Qué herramientas necesito?



**Para cuidar las piezas
armá el Placard sobre la caja.**

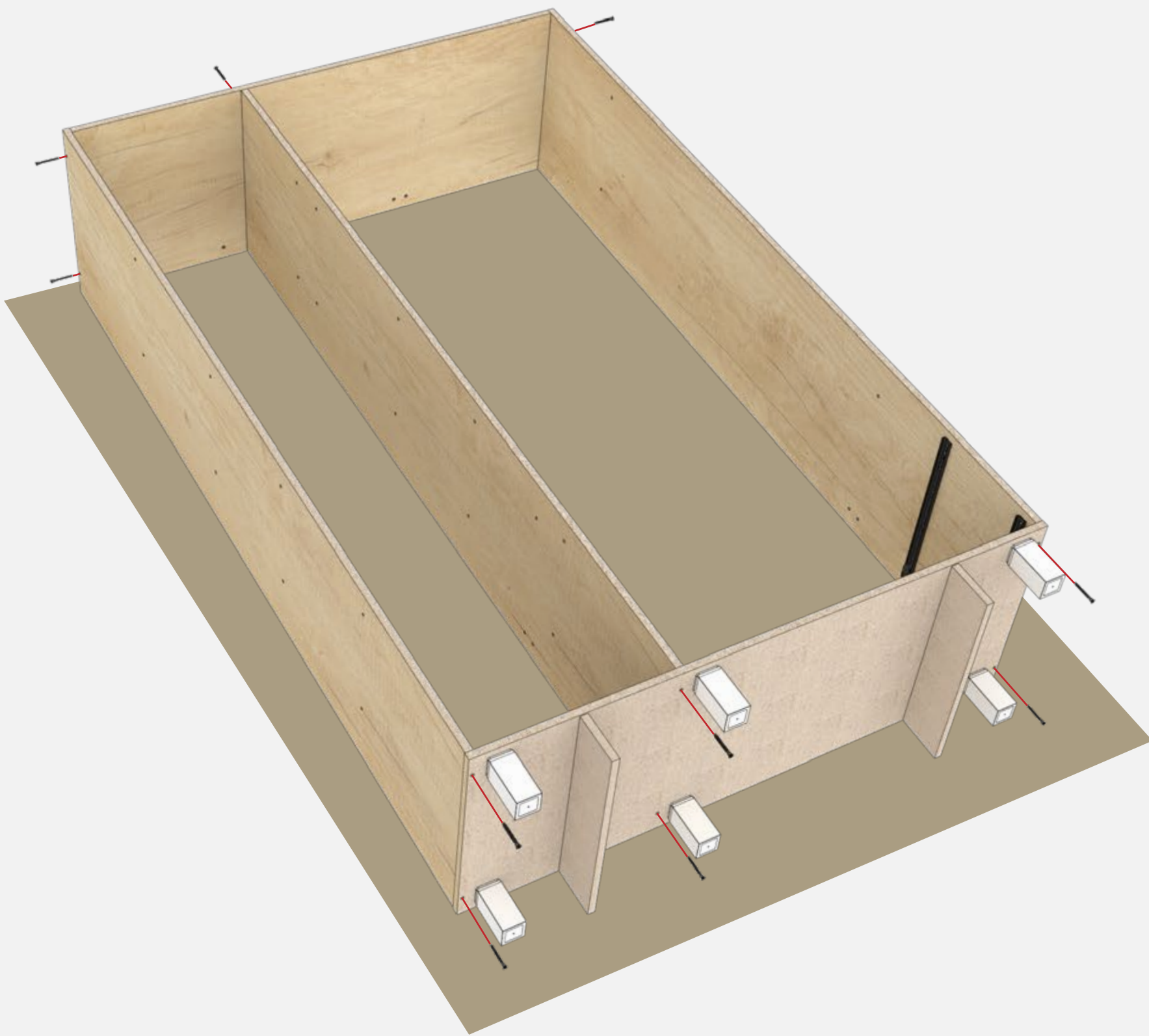

**Al momento de rotar, recomendamos
que sean dos personas.**

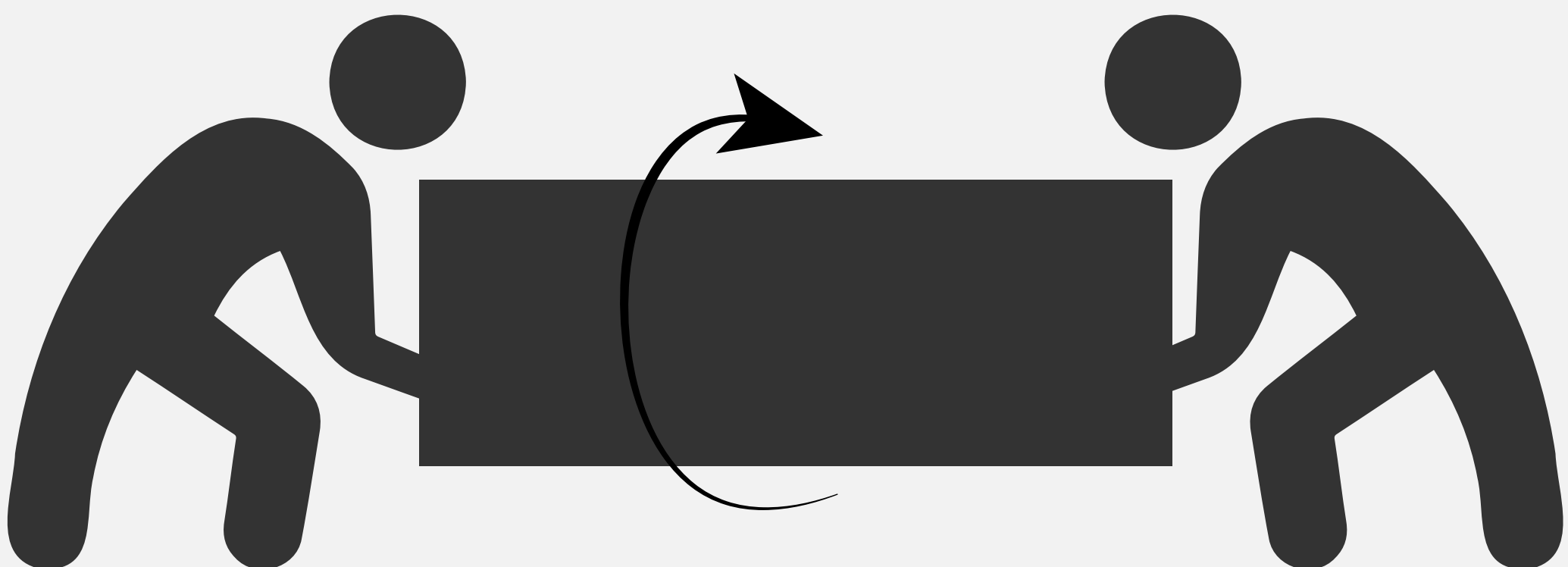

01

Paso 1 ¡Muy importante!

Colocar 2 soportes de armado para facilitar el giro del placard y evitar roturas de patas.



Los 2 soportes se retiran una vez finalizado el armado de la estructura (PASO 7).



H1
Tornillo
6.3x50 Allen

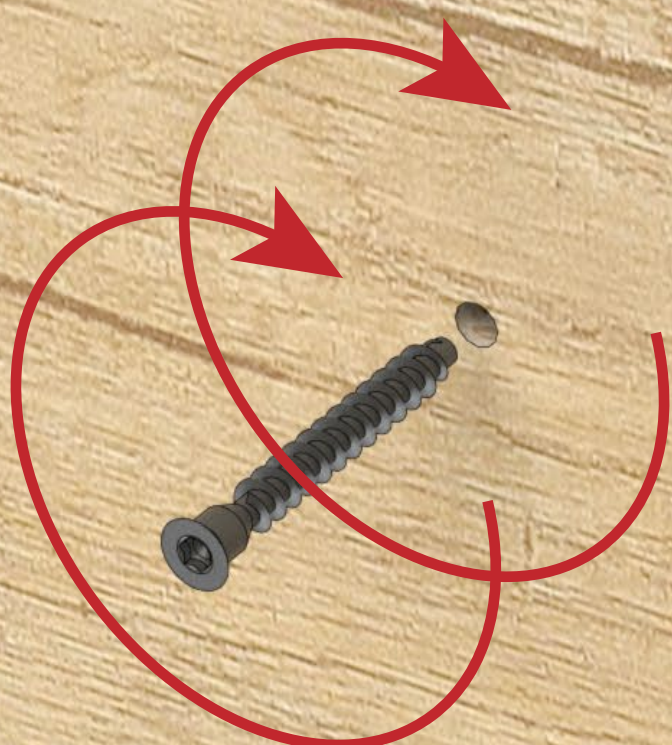

02

Colocar y ajustar patas

Colocar 6 patas plásticas. Cada una está vinculada con 4 tornillos 3.5x15. Ajustar patas hasta que hagan tope



P1
Base 3P
1182x443

H3
Pata plástica

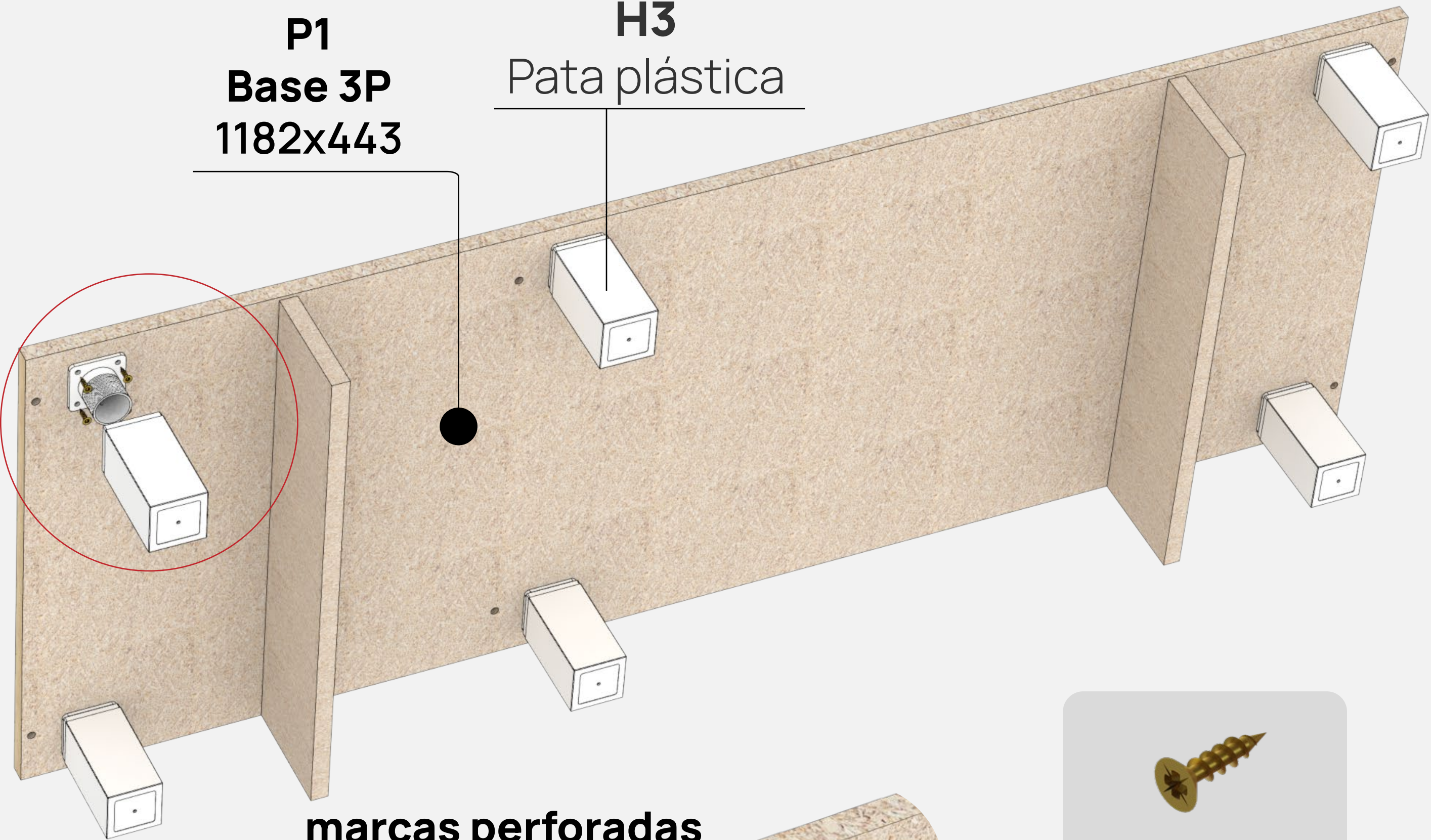

marcas perforadas

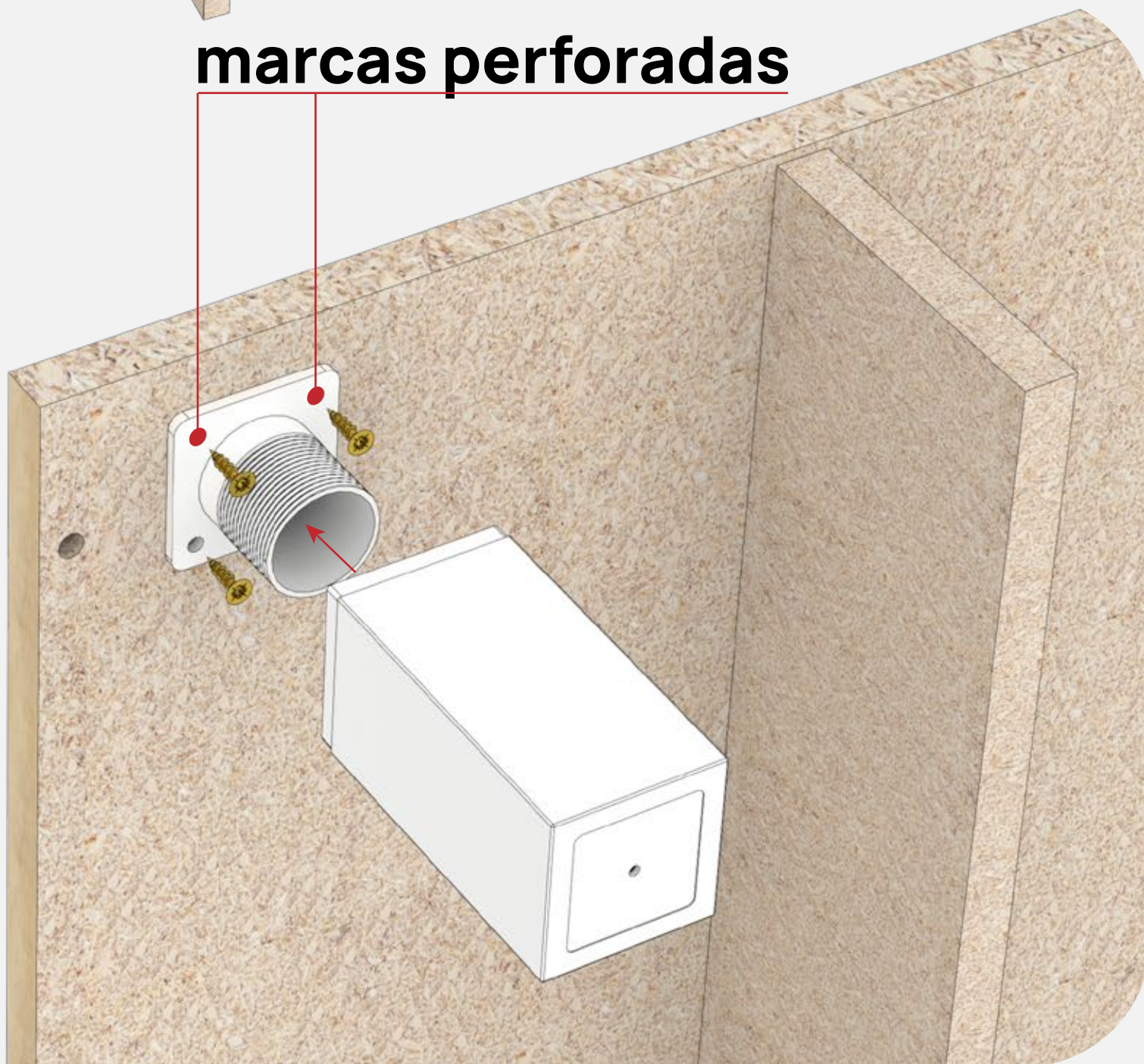

H2
Tornillo
3.5x15

Posicionar patas sobre las 2 marcas perforadas y ajustar 4 tornillos.

TOPE!

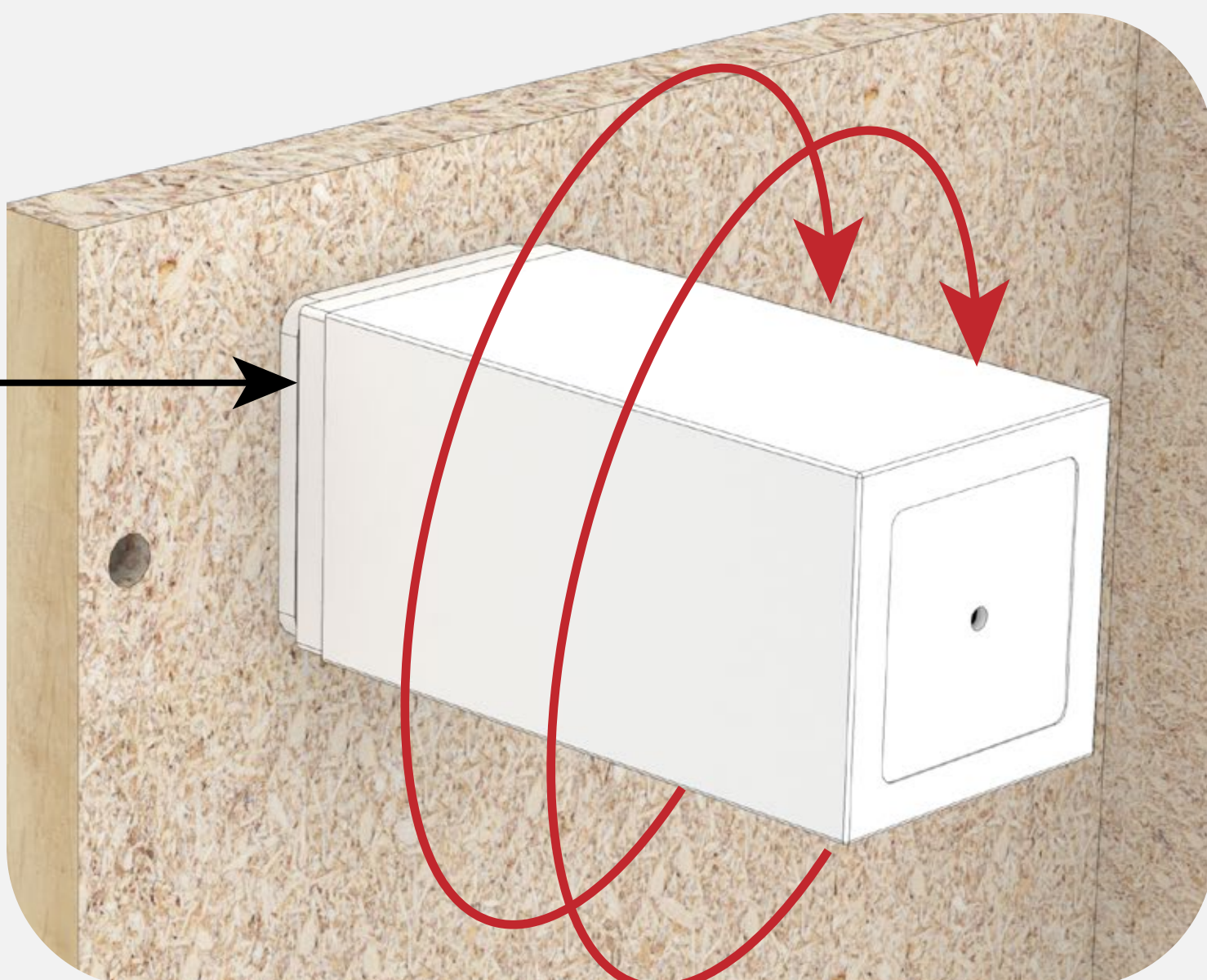

¡IMPORTANTE!
Ajustar las 6 patas hasta que hagan TOPE!

03

Colocar correderas

Vincular 2 correderas en costado izquierdo y 2 en parante.
Unir con 2 tornillos varianta cada una.



Filo melamina

P3
Costado Izq
1800x443

P5
Parante
1784x443

Filo melamina

zoom

zoom

H5

H5

H5

H5

H4
Corredera
Z 400

04

Armado de estructura

Vincular 2 costados y parante con las piezas base y techo mediante 12 tornillos confirmat.



P6

Techo 3P 1150x443

P3

Costado Izq

1800x443

P4

Costado Der

1800x443

P1

Base 3P

1182x443



H1

Tornillo
6.3x50 Allen



05

Vincular estantes

Sumar a la estructura 6 estantes y vincularlos con 4 tornillos allen cada uno.

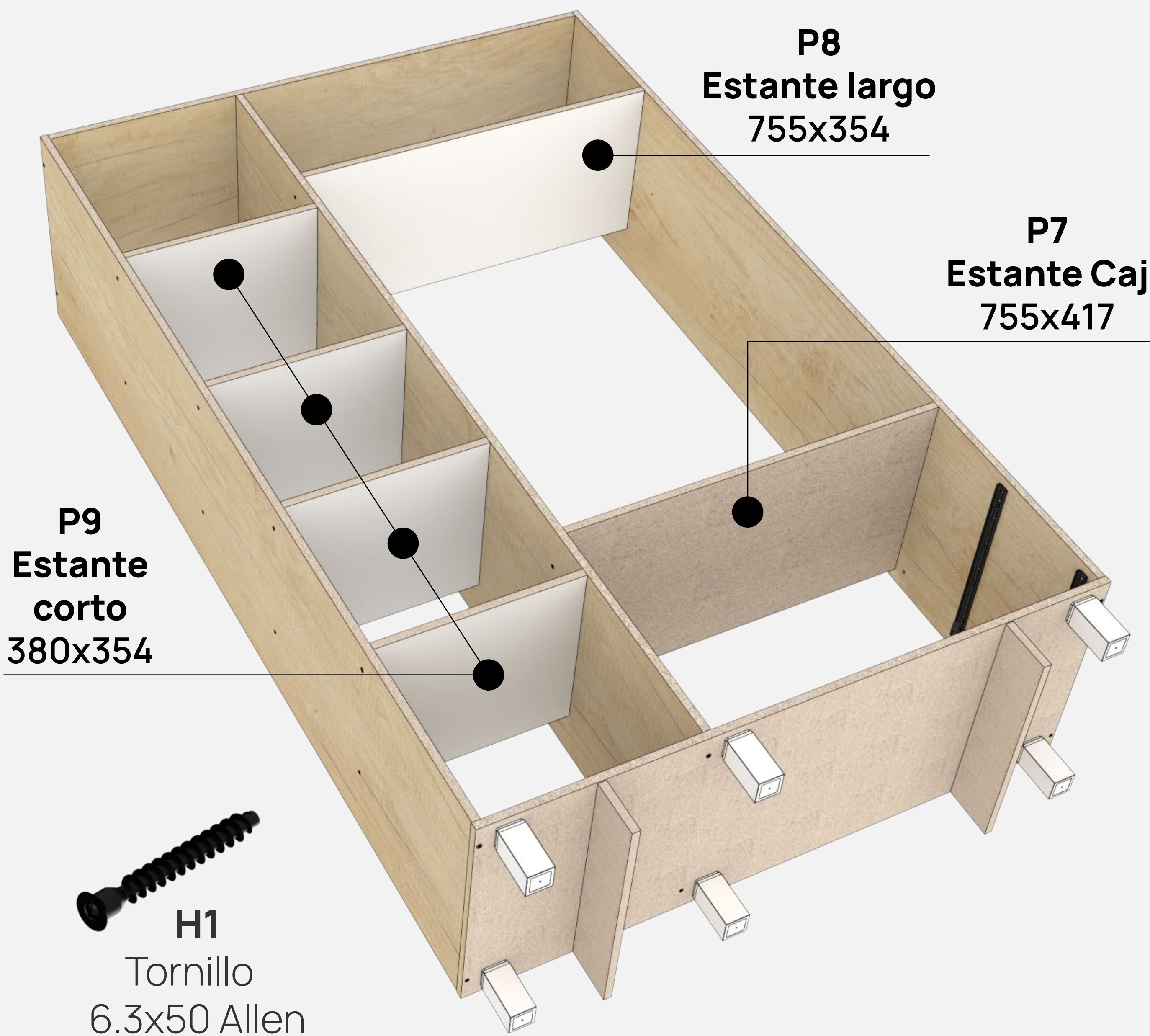

06

Colocar fondos

Corroborar que el mueble esté colocado en escuadra a 90° y clavar 3 fondos. Clavos cada 13 cm aprox.

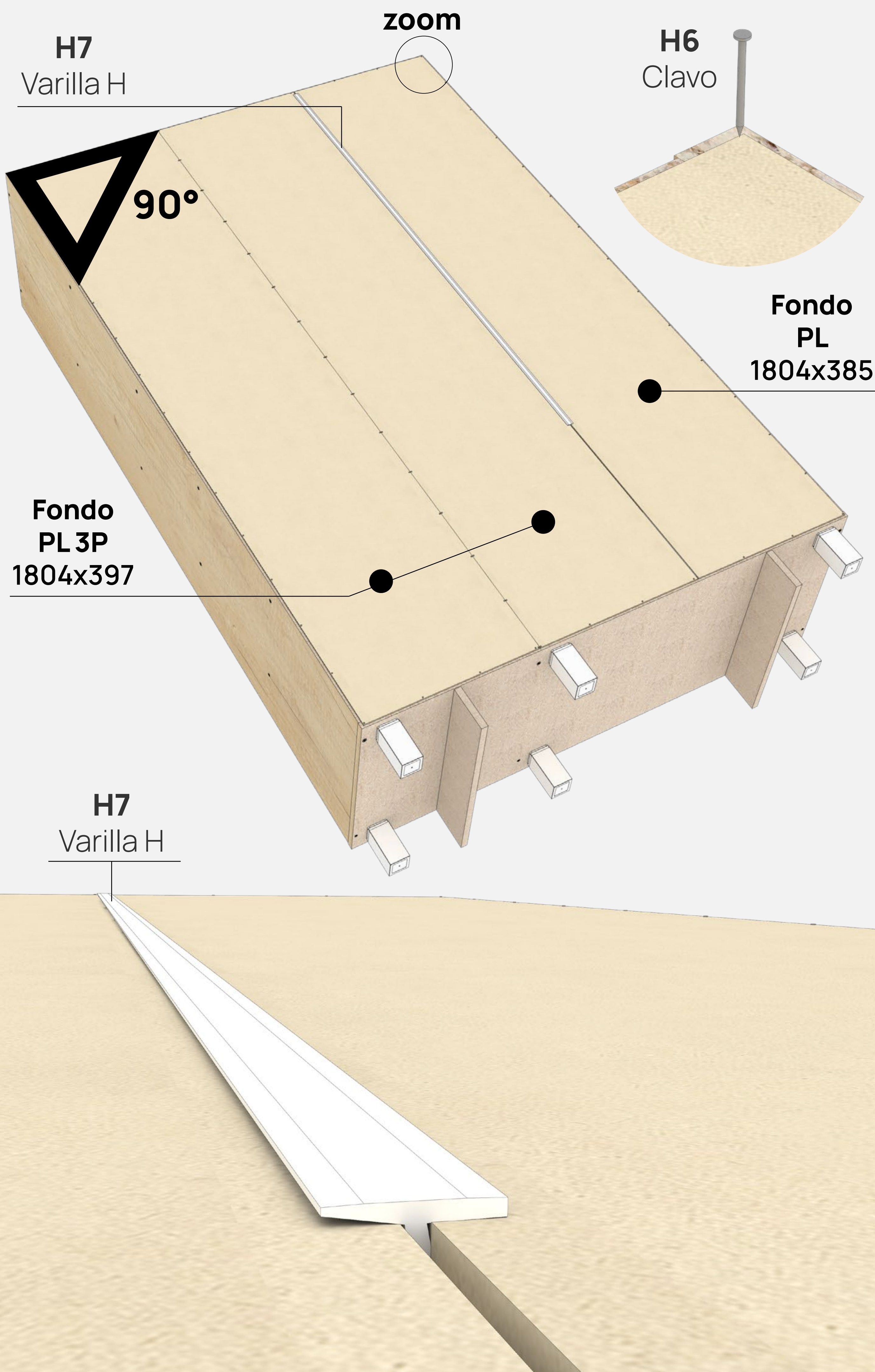
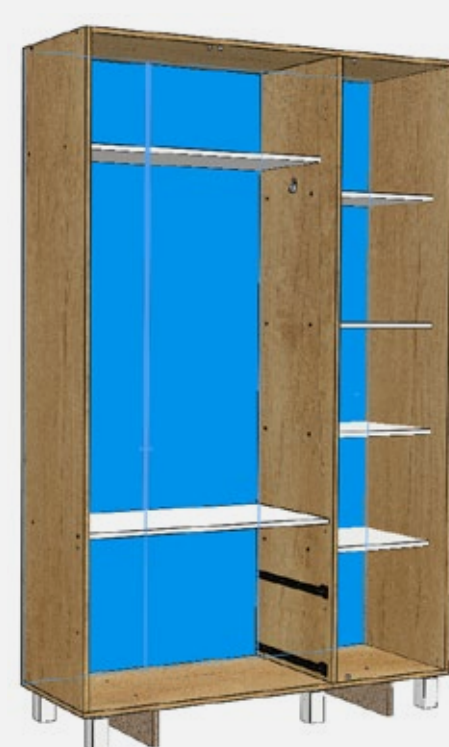

07

Paso importante!
Girar placard con soportes de armado colocados para evitar rotura de patas plásticas.



PASO A

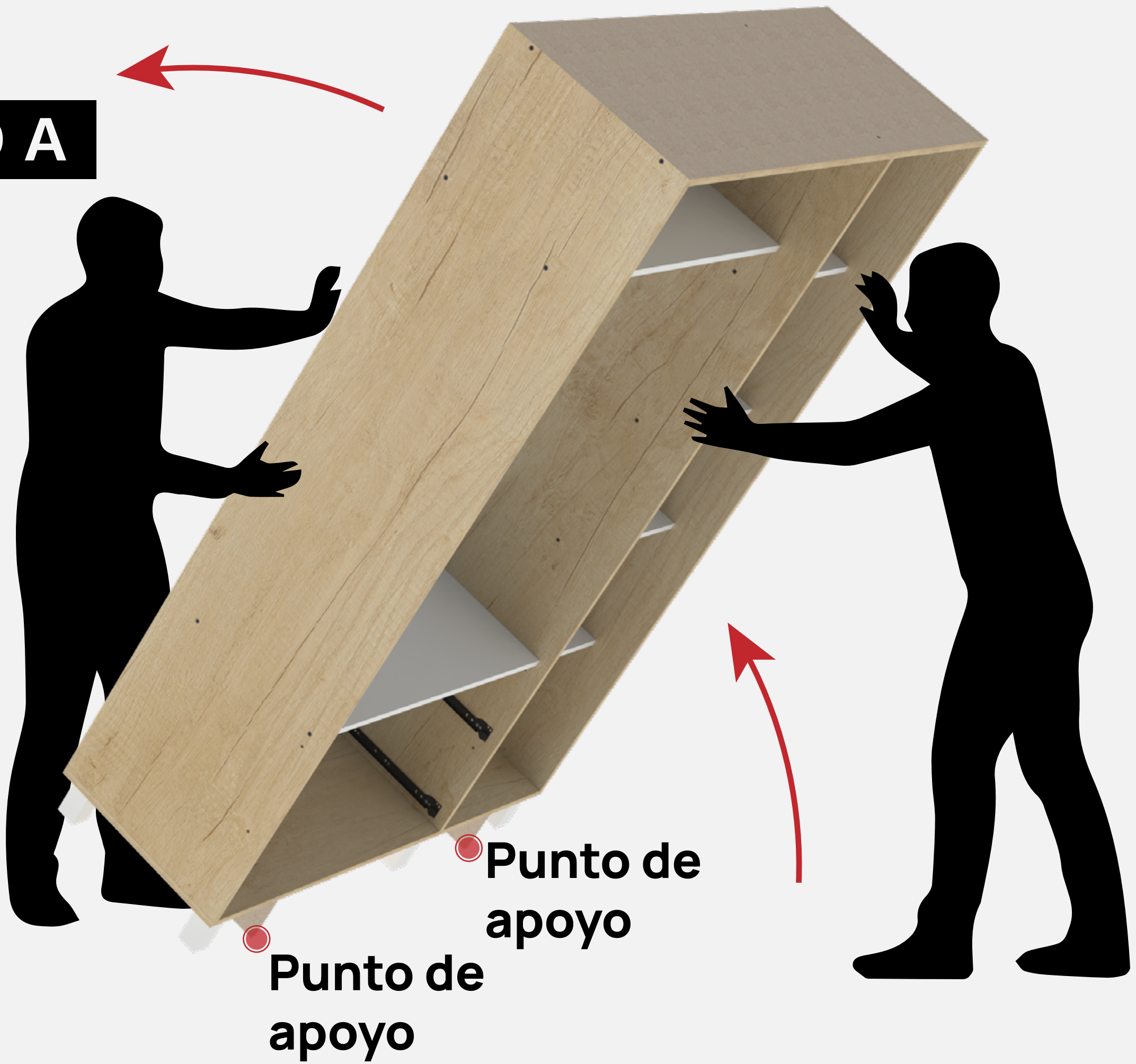

PASO B

Quitar 4 tornillos de soportes y empujar levemente. Luego retirar ambos soportes!



08

Colocar fajas de cajón

Vincular 2 fajas cajón con 4 tornillos Allen. Los tornillos se usaron previamente para vincular soportes de armado.



H8
Soporte estante

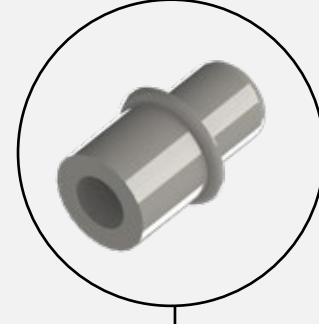

H10
Soporte
Lat. barral

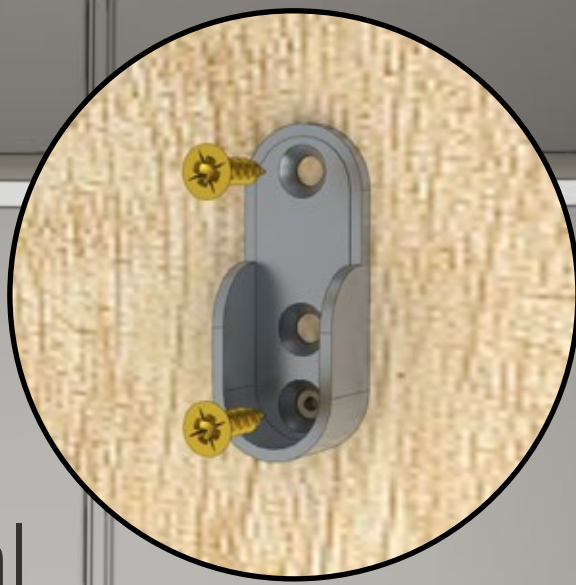

P10
Faja cajón
755x70



H9
Tapón
6 mm

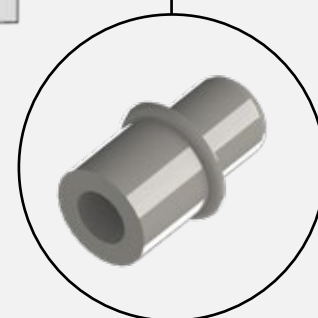

09

Frentes de cajones

Enroscar 2 pernos minifix,
hasta que hagan tope!

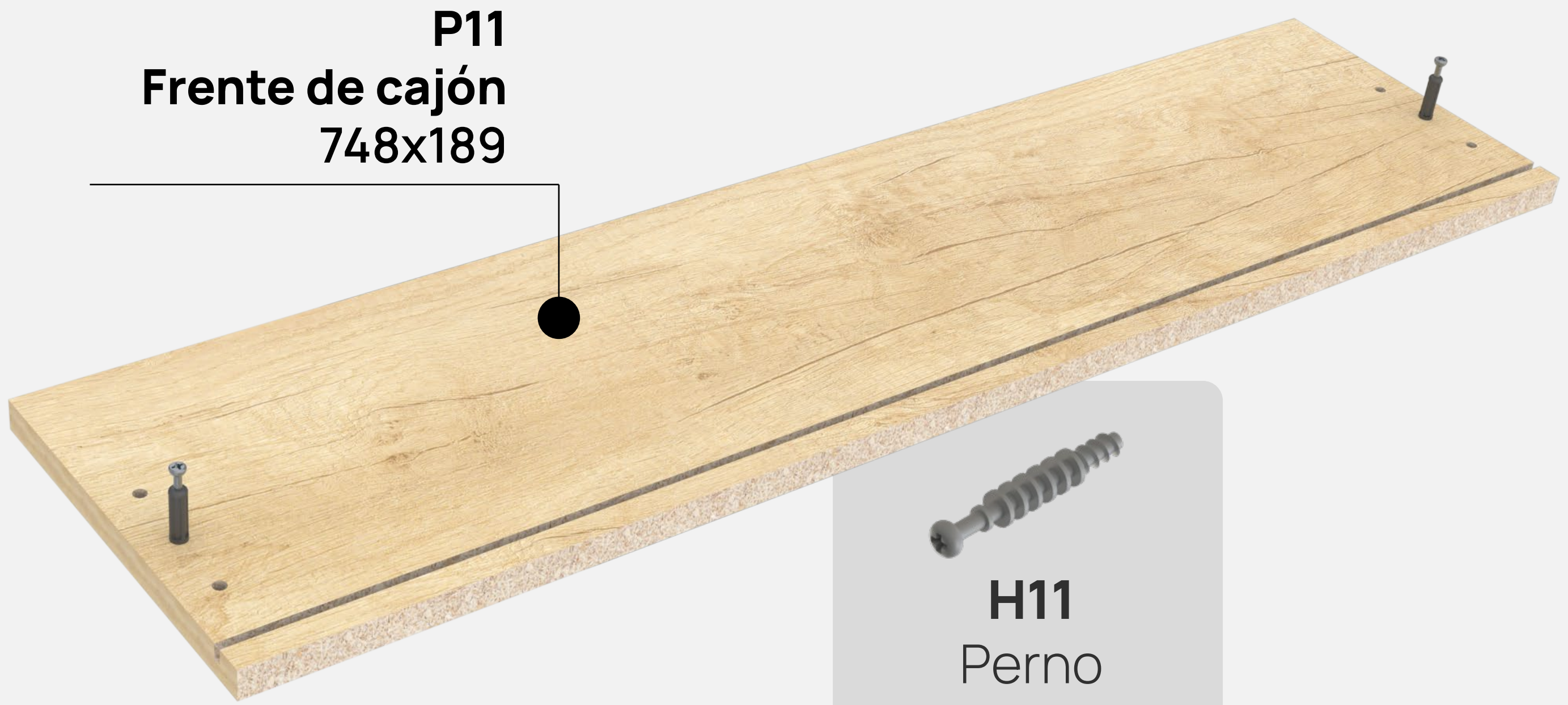
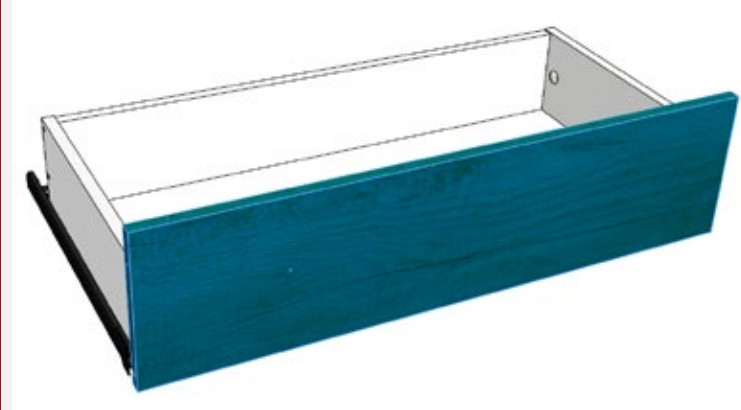

Ajustar hasta
que haga **tope!**



10

Costado de cajón

Colocar a presión **cazoletas**,
tapones y **tarugos**.

Encolar perforaciones antes
de colocar tarugos.

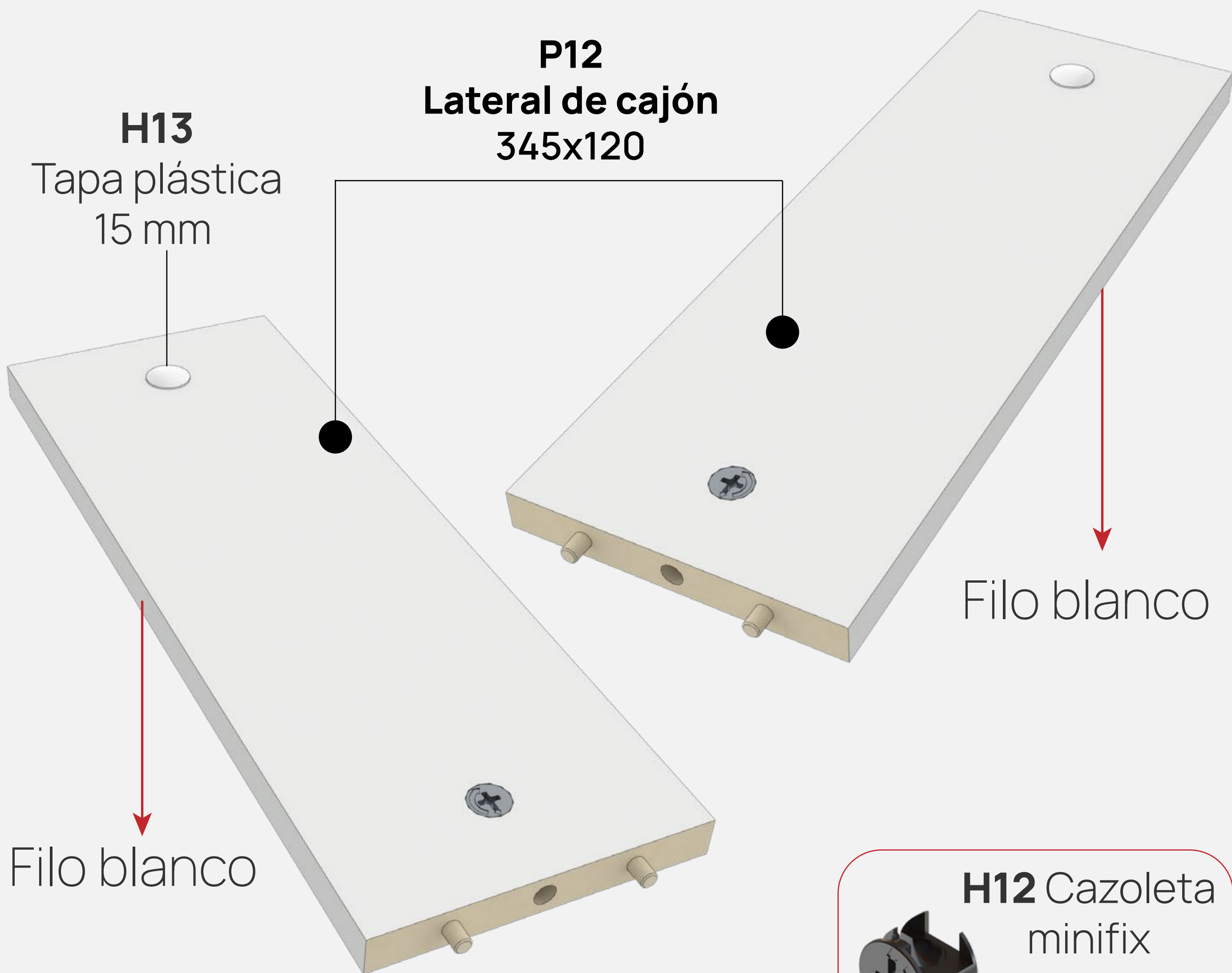
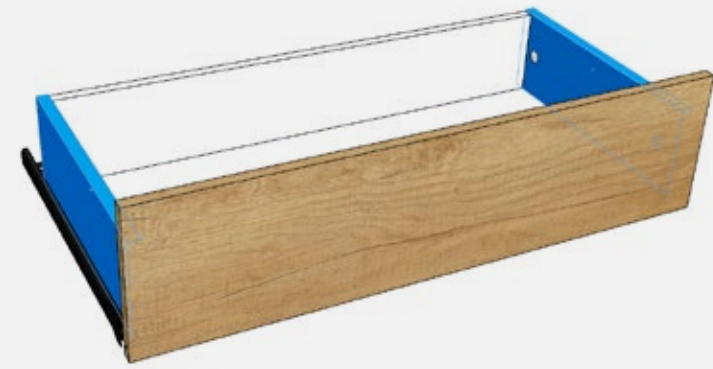

Colocar **cazoleta minifix** con la flecha
hacia apuntando hacia la perforación.

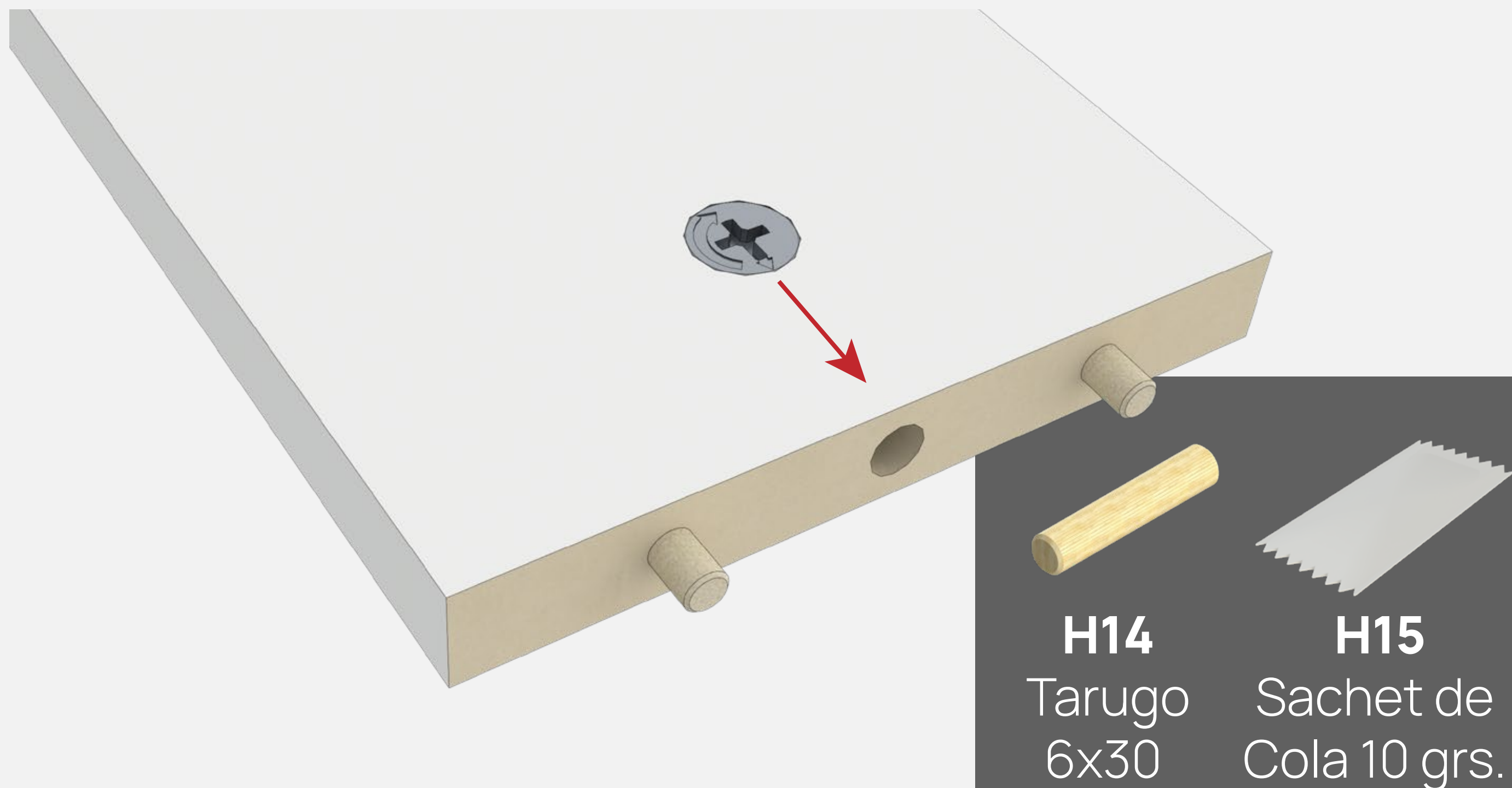

H14
Tarugo
6x30

H15
Sachet de
Cola 10 grs.

11

Armar cajones

Unir laterales de cajón con frente y contrafrente.
Mantener cajón escuadrado a 90°



H19 Tornillo 3.5x30



Contrafrente
699x118

P12
Lateral de cajón

90°

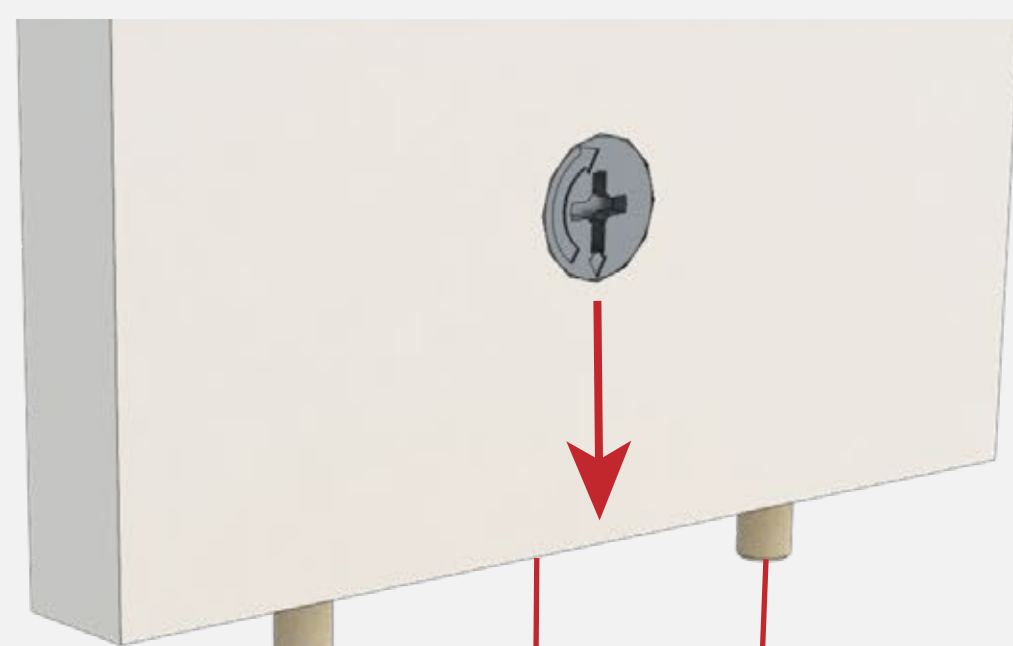

AJUSTAR 180°

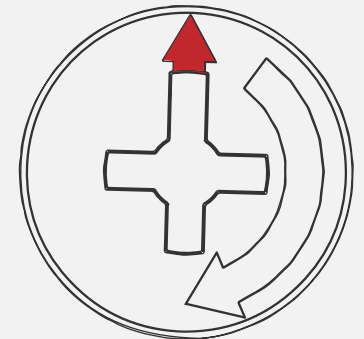
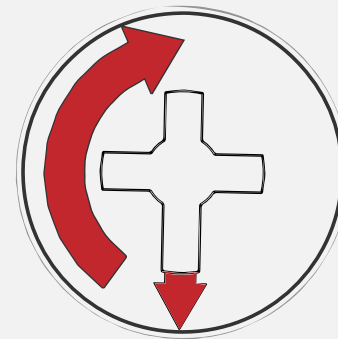

12

Colocar fondo

Clavar fondo de cajón. Es muy importante verificar escuadra a 90°. Clavos cada 12 cm. aprox

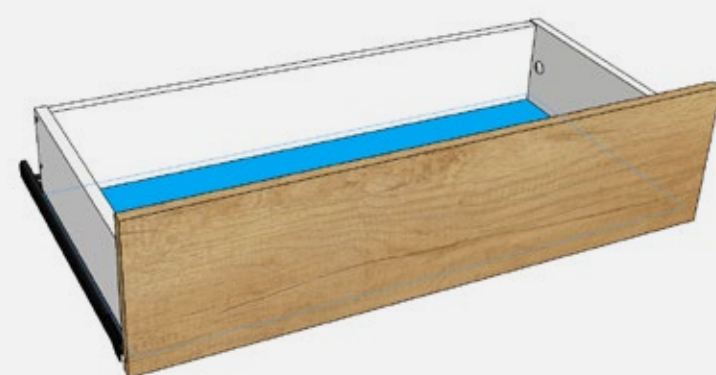

Fondo
cajón
727x352

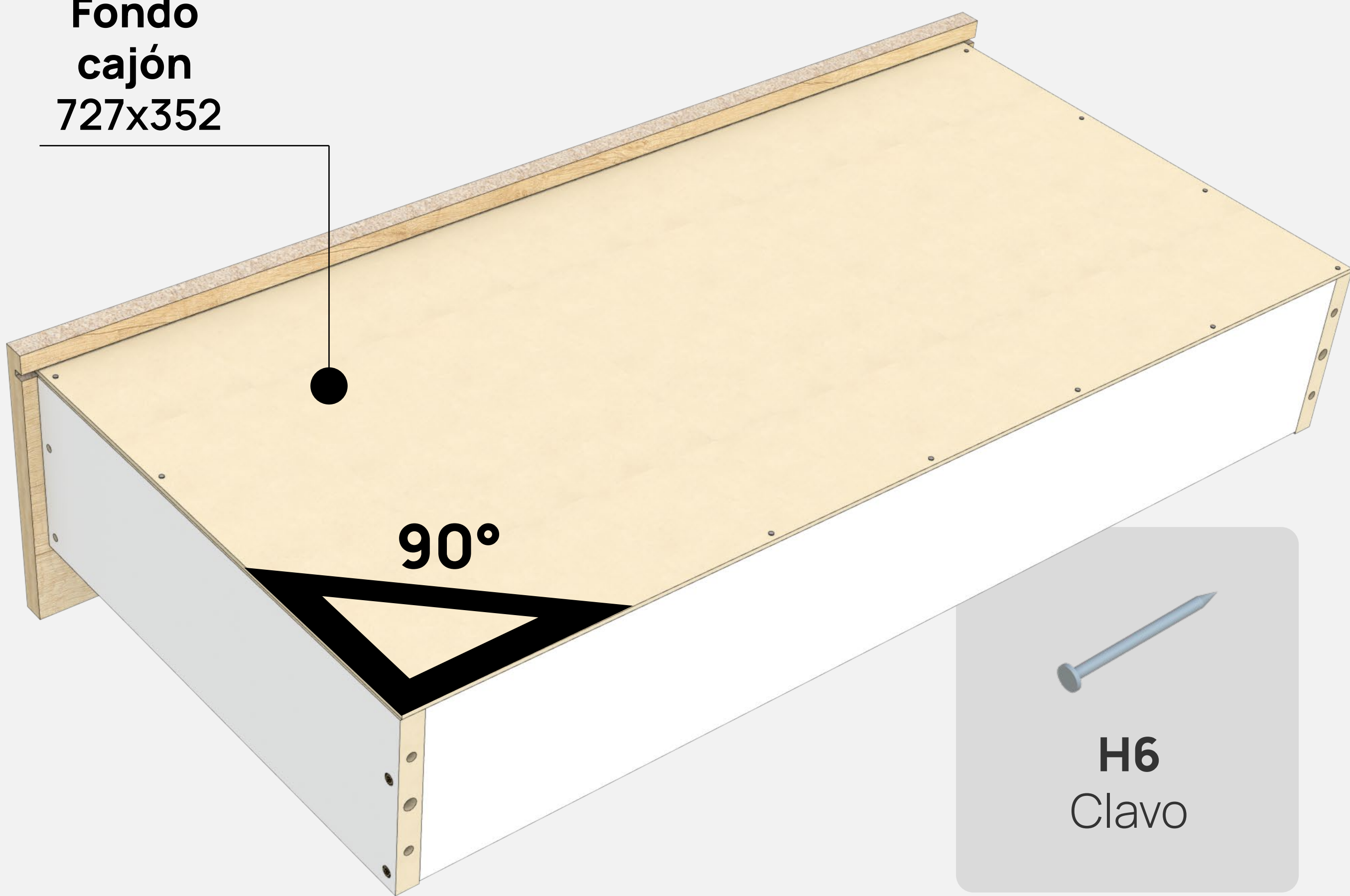

90°

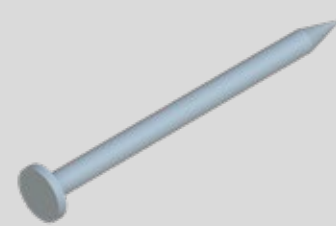

H6
Clavo

P11
Frente de cajón
748x189



Encastrar
fondo en
frente y
luego clavar

13

Colocar correderas

Colocar 2 correderas en Cajones.
Cada corredera se vincula
con **2 tornillos 3.5x15.**

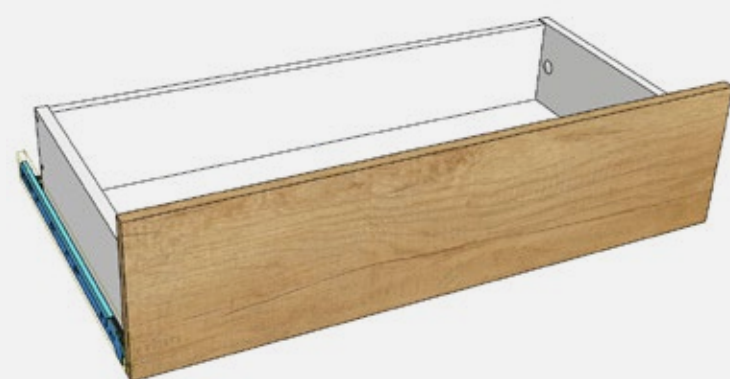

H4
Corredera
Z 400

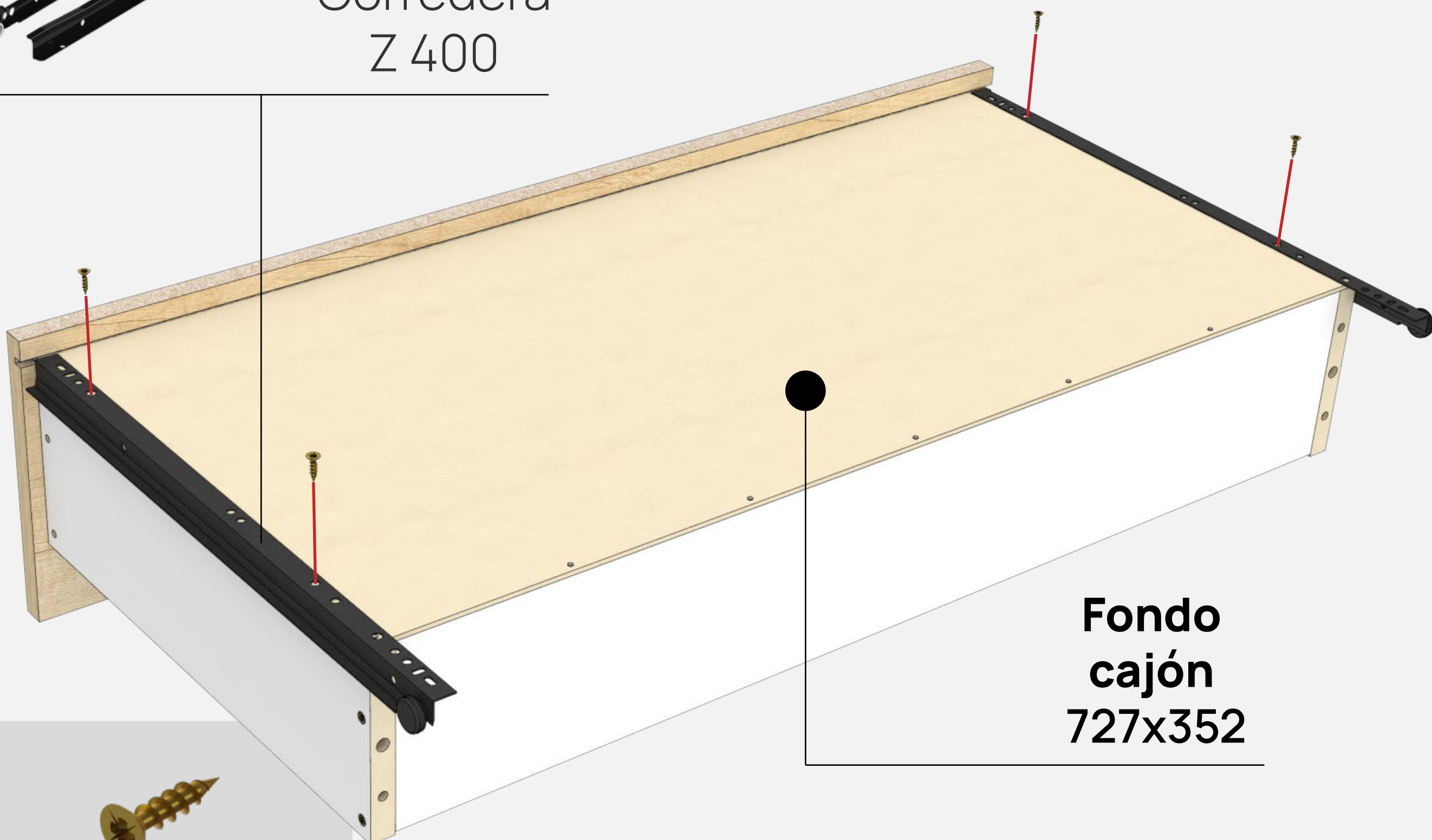

**Fondo
cajón
727x352**



H2
Tornillo
3.5x15



14

Armar 3 puertas

Colocar 3 bisagras y 1 manija en cada una de las puertas.

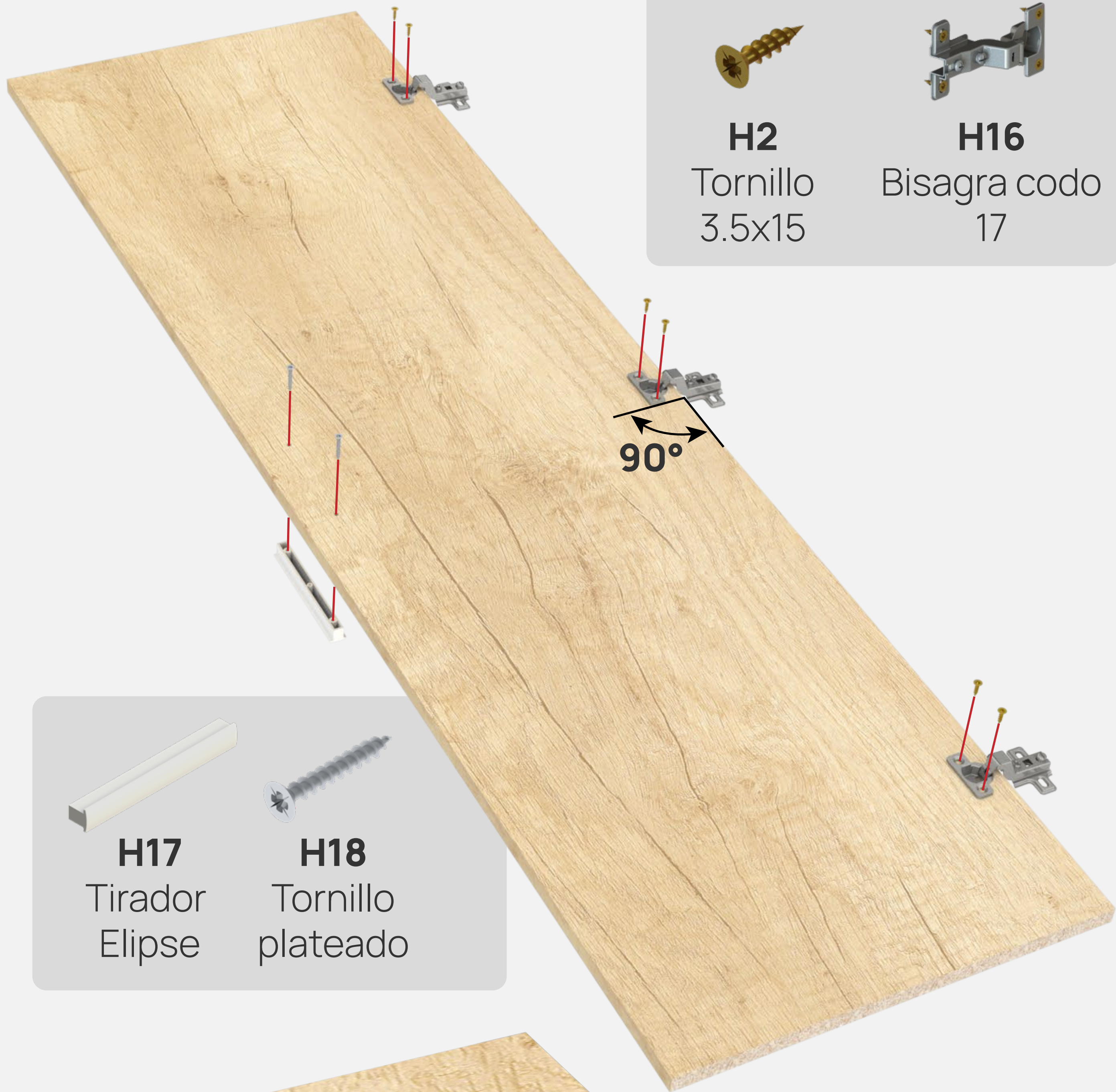

H2
Tornillo
3.5x15

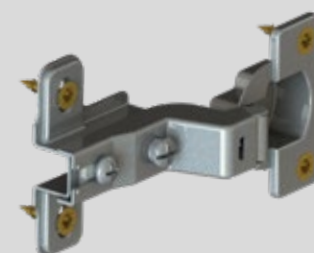

H16
Bisagra codo
17



H17
Tirador
Elipse

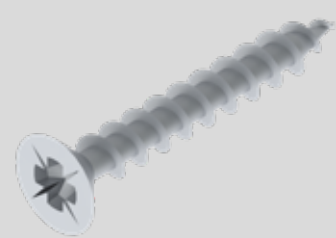

H18
Tornillo
plateado

90°

90°

15

Colgar puertas

Colgar 3 puertas y regular
9 bisagras.

Colocar barral de colgado.



H20
Barral
de colgado

P14
Puerta
larga
1775x372

P13
Puerta
corta
1327x372

P13
Puerta
corta
1327x372



Tornillo para
ajuste frontal

Tornillo para
ajuste horizontal

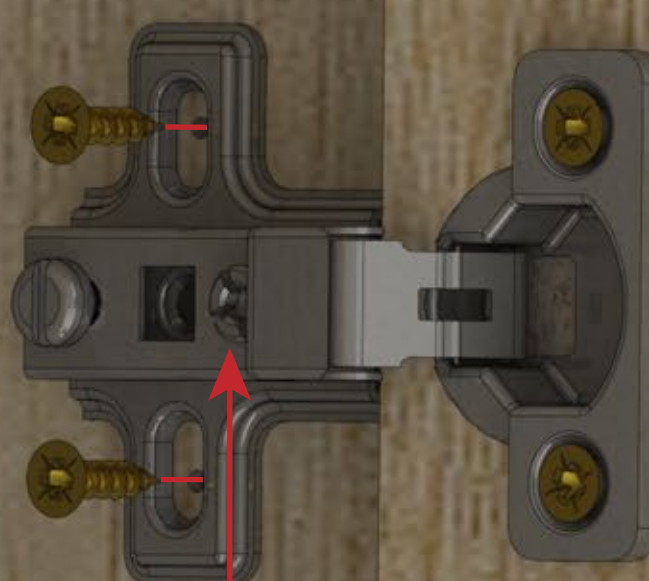

Las bisagras
cuentan
con 2 tornillos
de regulación,
que permiten
alinearse las
puertas.

16

Último paso!

Deslizar cajones como indica el gráfico.



**CAJÓN
ARMADO**

**Corredera
de costado**

**Corredera
de cajón**

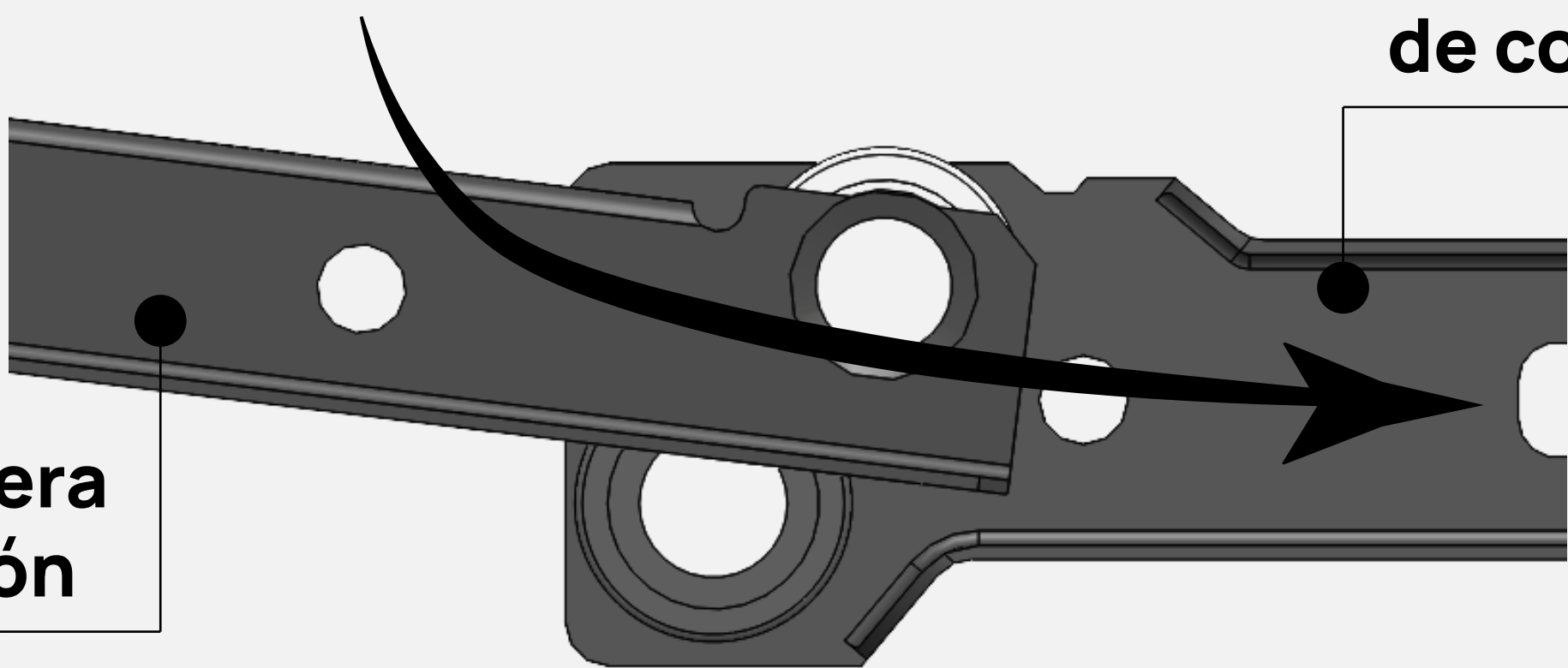

Terminaste!

Disfrutá tu Placard Geo



#ExperienciaMosconi