

LOTE 1

Seguí los
pasos
y armá tu
Placard **Geo 4 puertas**



Abrí la caja y posicioná
las piezas en el piso.

CAJA 1
DE 2



Cant. 2

Soporte de armado

440x102

P2

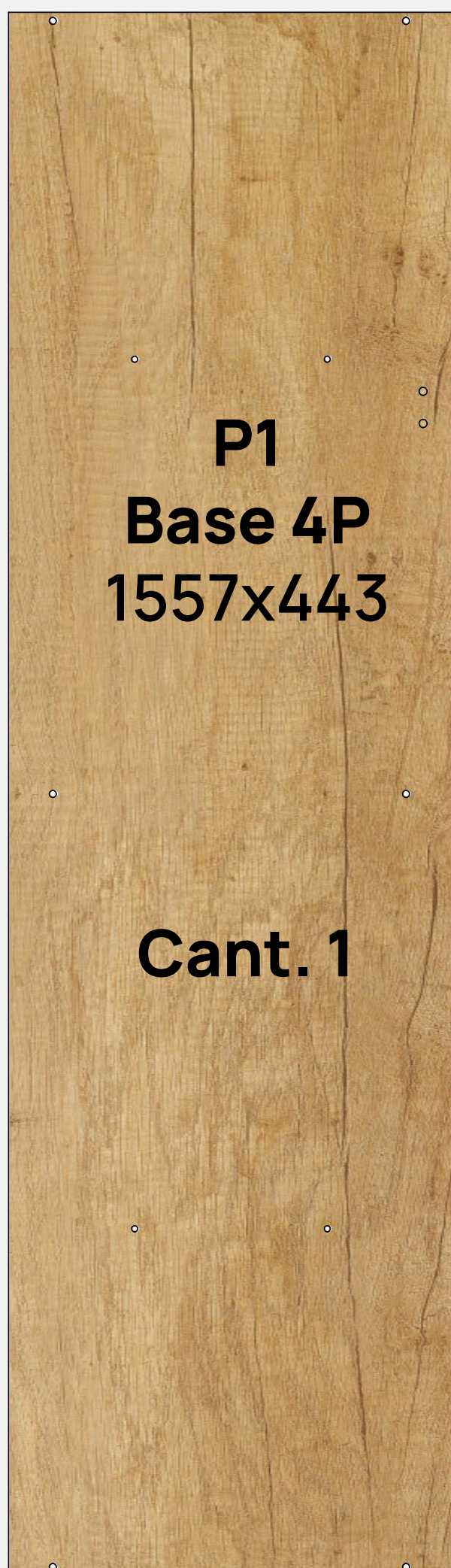

P1

Base 4P
1557x443

Cant. 1

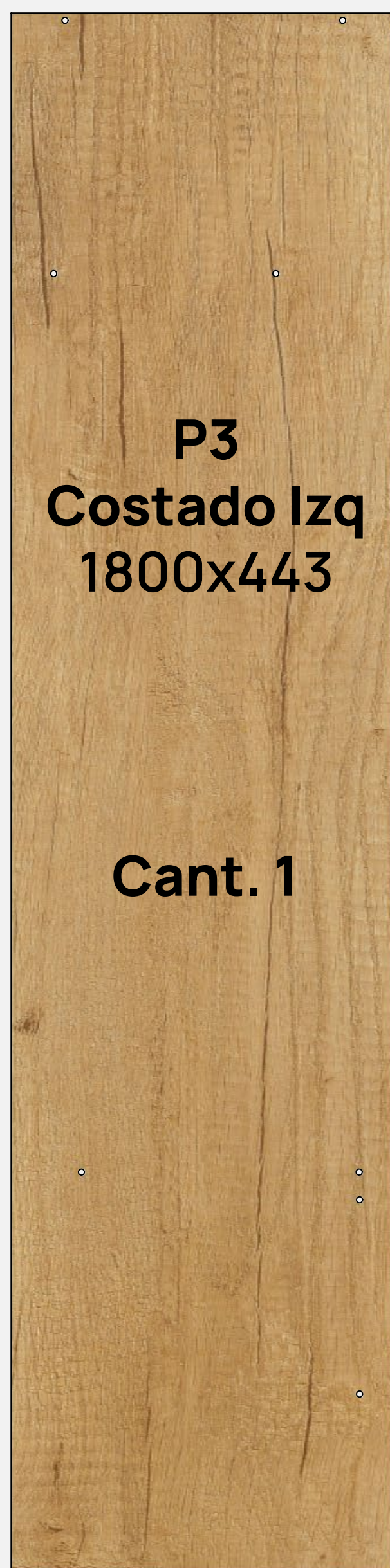

P3

Costado Izq
1800x443

Cant. 1



P4

Costado Der
1800x443

Cant. 1



P5

Parante
1784x443

Cant. 1



P6

Techo 4P
1525x443

Cant. 1

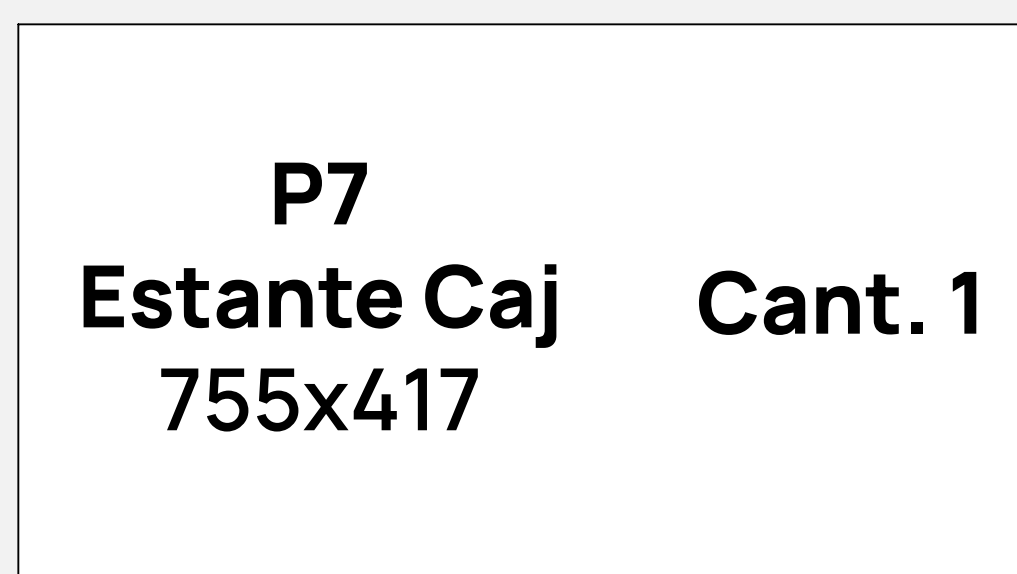

P7

Estante Caj
755x417

Cant. 1

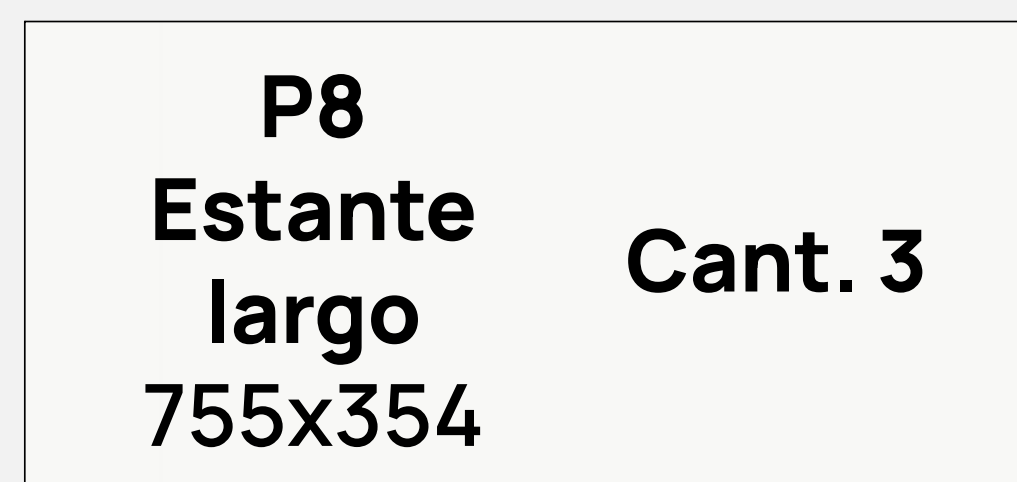

P8

Estante
largo
755x354

Cant. 3



Cant. 2

P10

Faja cajón
755x70

Abrí la caja y posicioná
las piezas en el piso.

CAJA 2
DE 2

P8
Estante
largo
755x354
Cant. 2



Cant. 2

P11
Frente de cajón
748x189

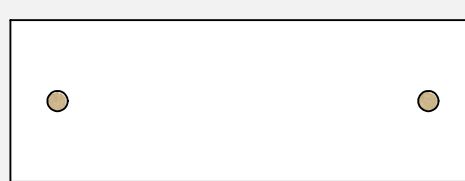

Cant. 4

P12
Lateral de cajón
345x120



Cant. 2

Puntera 4P
380x100



Cant. 2

Contrafrente
699x118



P13
Puerta
corta
1327x372

Cant. 2



P14
Puerta
larga
1775x372

Cant. 2

Fondo
cajón
727x352

Cant. 2

Fondo
PL
1804x385

Cant. 4

Herrajes



H1
Tornillo
6.3x50 Allen

40 ud.



H2
Tornillo
3.5x15

84 ud.



H3
Pata
plást. cuad.
100mm

6 ud.



H4
Corredera
Z 400

2 ud.



H5
Tornillo
variante 6x8

8 ud.



H6
Clavo

1 bolsa

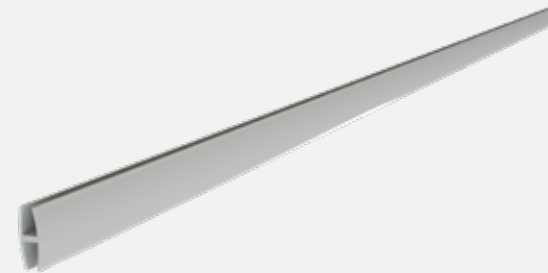

H7
Varilla H

2 ud.



H8
Soporte
estante

6 ud.



H9
Tapón
6 mm

2 ud.



H10
Soporte
Lat. barral

2 ud.



H11
Perno
minifix

4 ud.



H12
Cazoleta
minifix

4 ud.

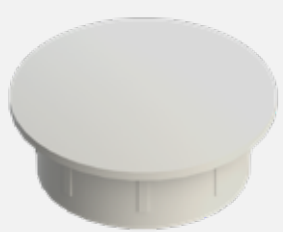

H13
Tapa plástica
15 mm

4 ud.



H14
Tarugo
6x30

8 ud.

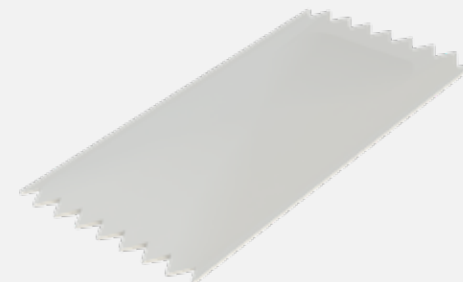

H15
Sachet de
Cola 10 grs.

1 ud.



H16
Bisagra codo
17

12 ud.



H17
Tirador Elipse
96 mm

4 ud.

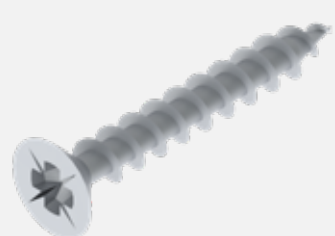

H18
Tornillo 3.5x25
plateado

8 ud.



H19
Tornillo
3.5x30

8 ud.



H20
Barral
de colgado

1 ud.

¿Qué herramientas necesito?



**Para cuidar las piezas
armá el Placard sobre la caja.**

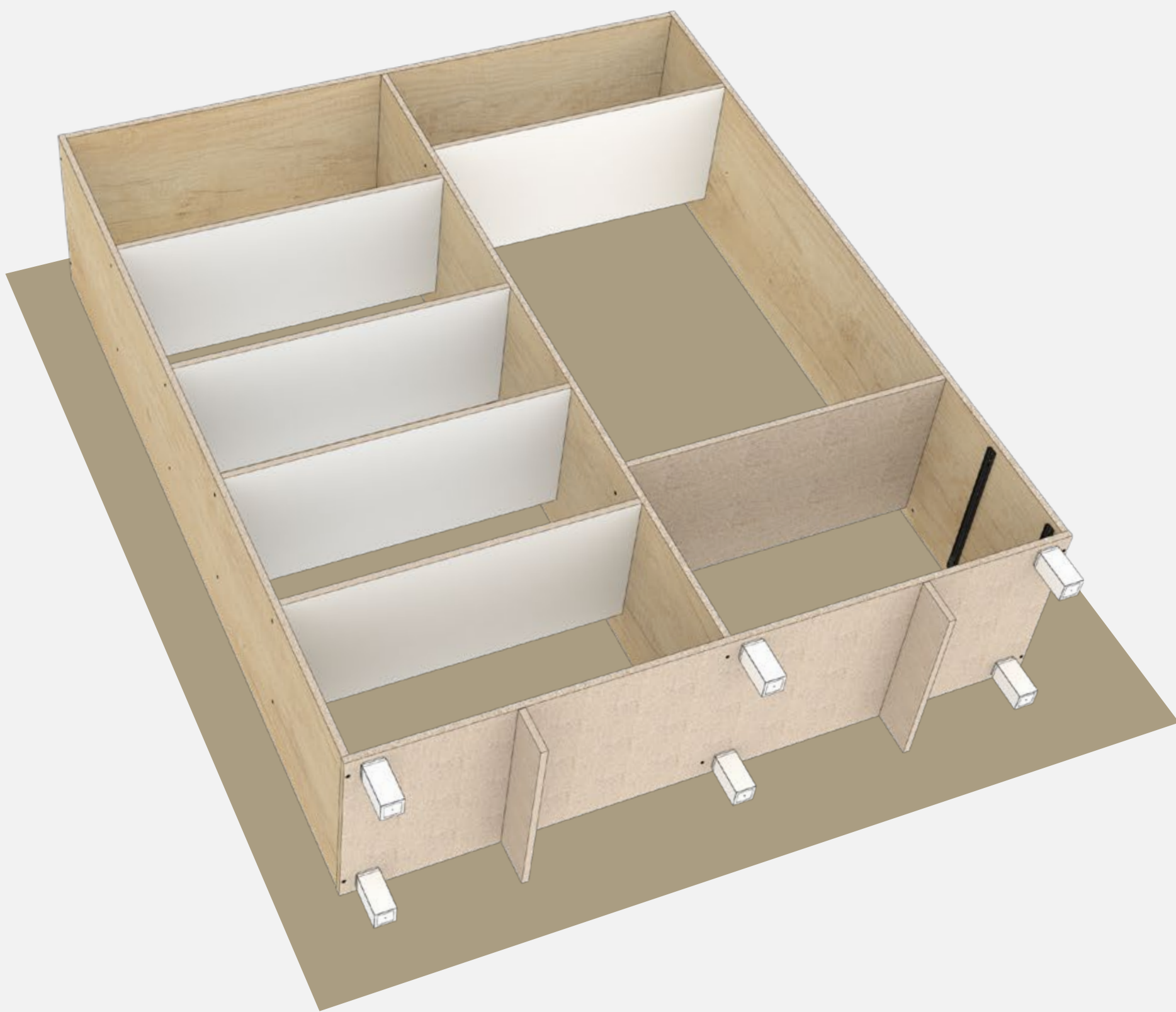

**Al momento de rotar, recomendamos
que sean dos personas.**

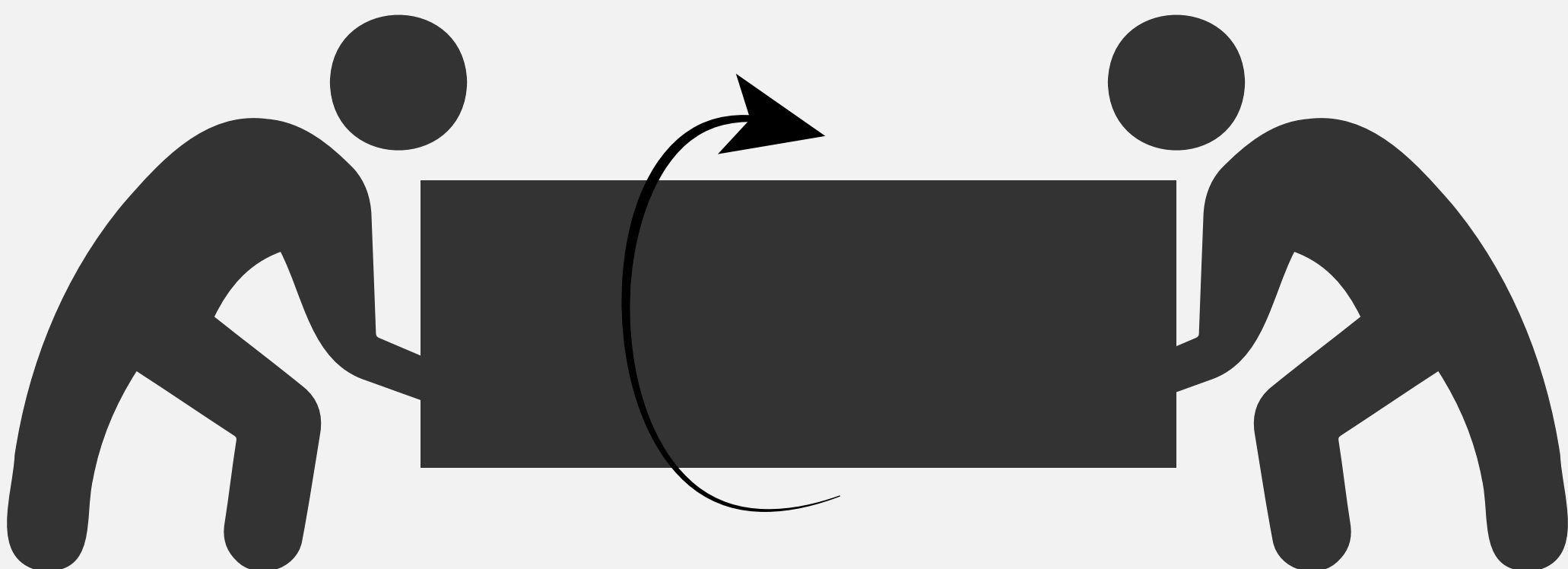

01

Paso 1 ¡Muy importante!

Colocar 2 soportes de armado para facilitar el giro del placard y evitar roturas de patas.

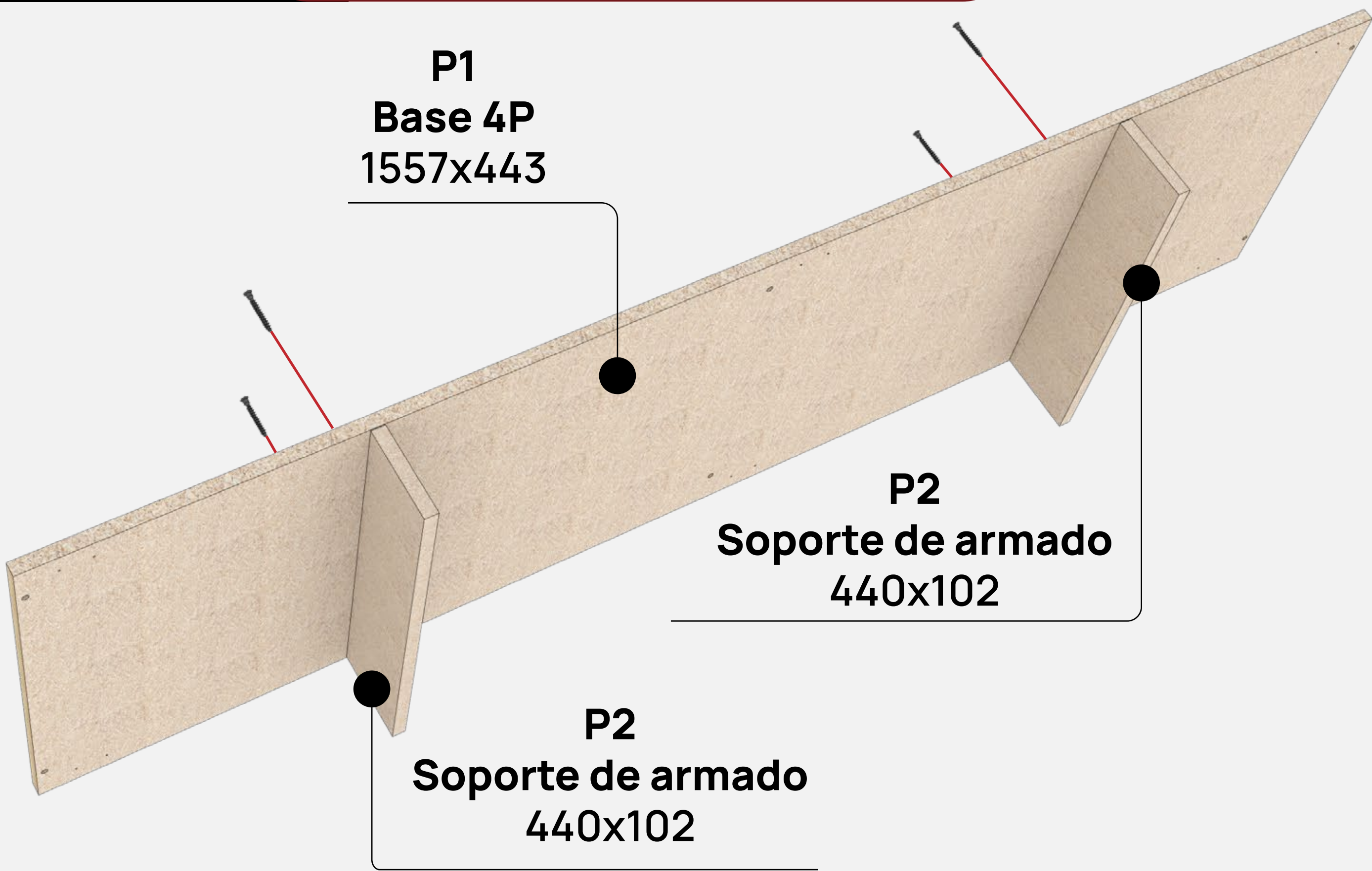

Los 2 soportes se retiran una vez finalizado el armado de la estructura (PASO 7).



H1
Tornillo
6.3x50 Allen

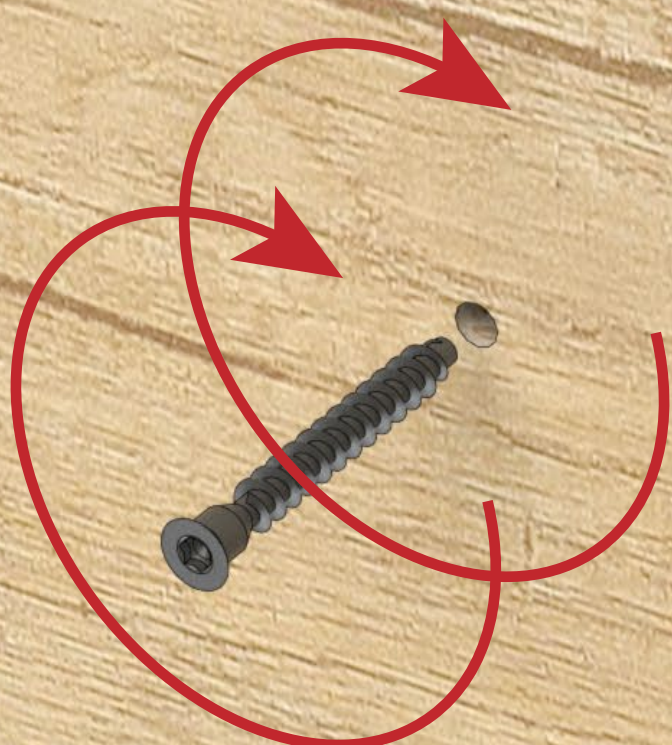

02

Colocar y ajustar patas

Colocar 6 patas plásticas, cada una esta vinculada con 4 tornillos 3.5x15. Ajustar patas hasta que hagan tope



H3

Pata plást. cuadrada

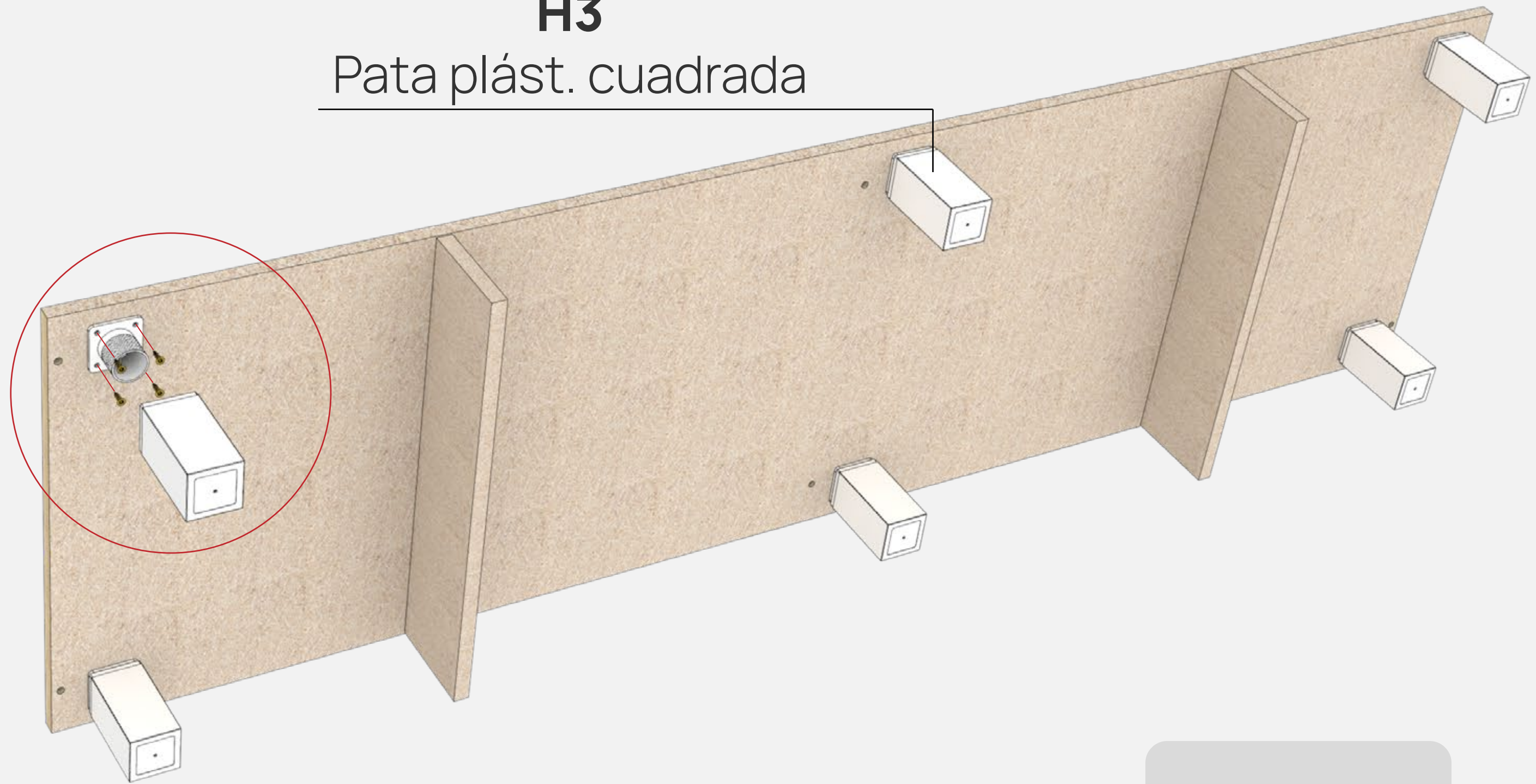

marcas perforadas

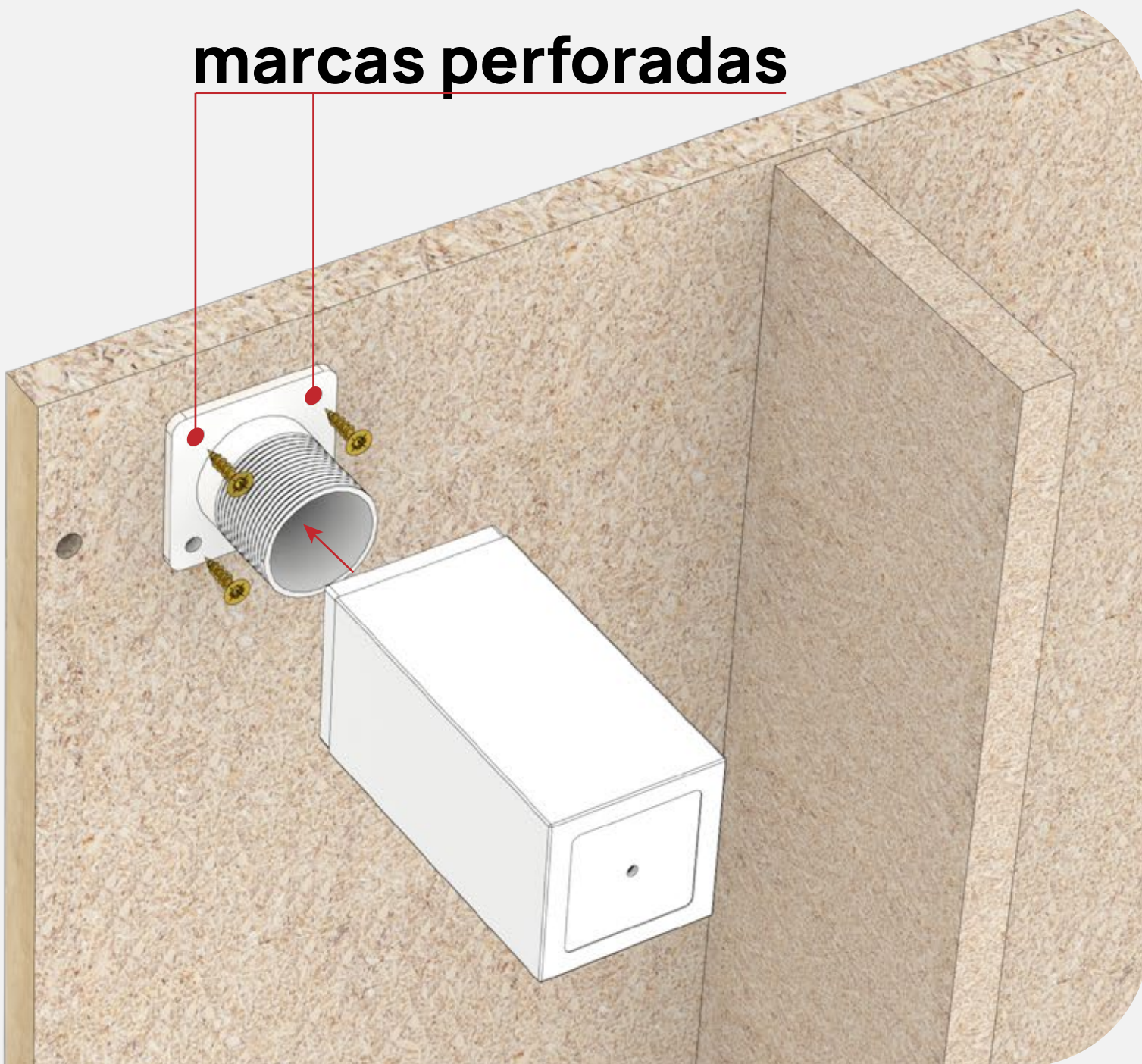

H2

Tornillo
3.5x15

Posicionar patas sobre las 2 marcas perforadas y ajustar 4 tornillos.

TOPE!

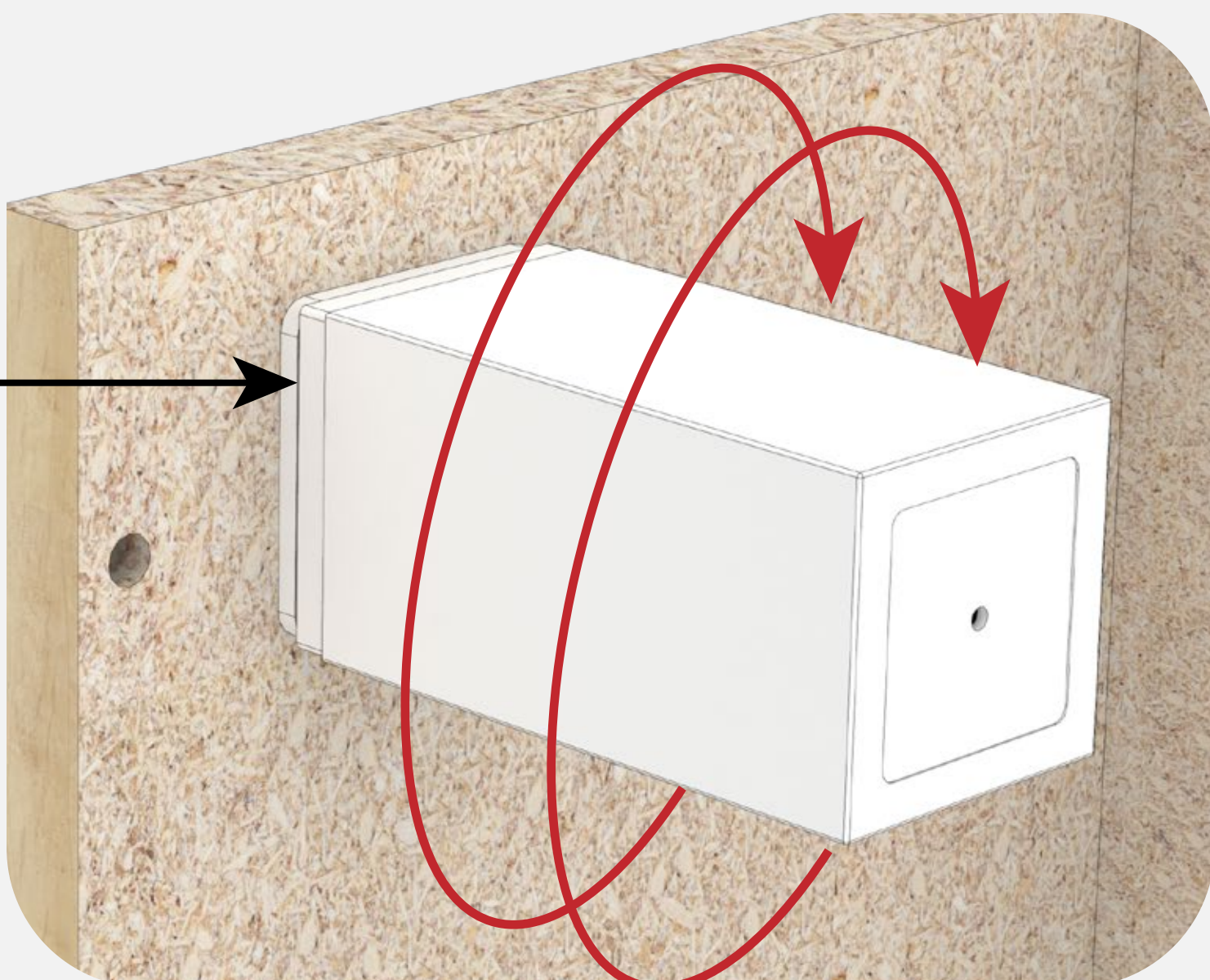

¡IMPORTANTE!

Ajustar las 6 patas hasta que hagan TOPE!

03

Colocar correderas

Vincular 2 correderas en costado izquierdo y 2 en parante.
Unir con 2 tornillos varianta cada una.



P3
Costado Izq
1800x443



P5
Parante
1784x443

zoom

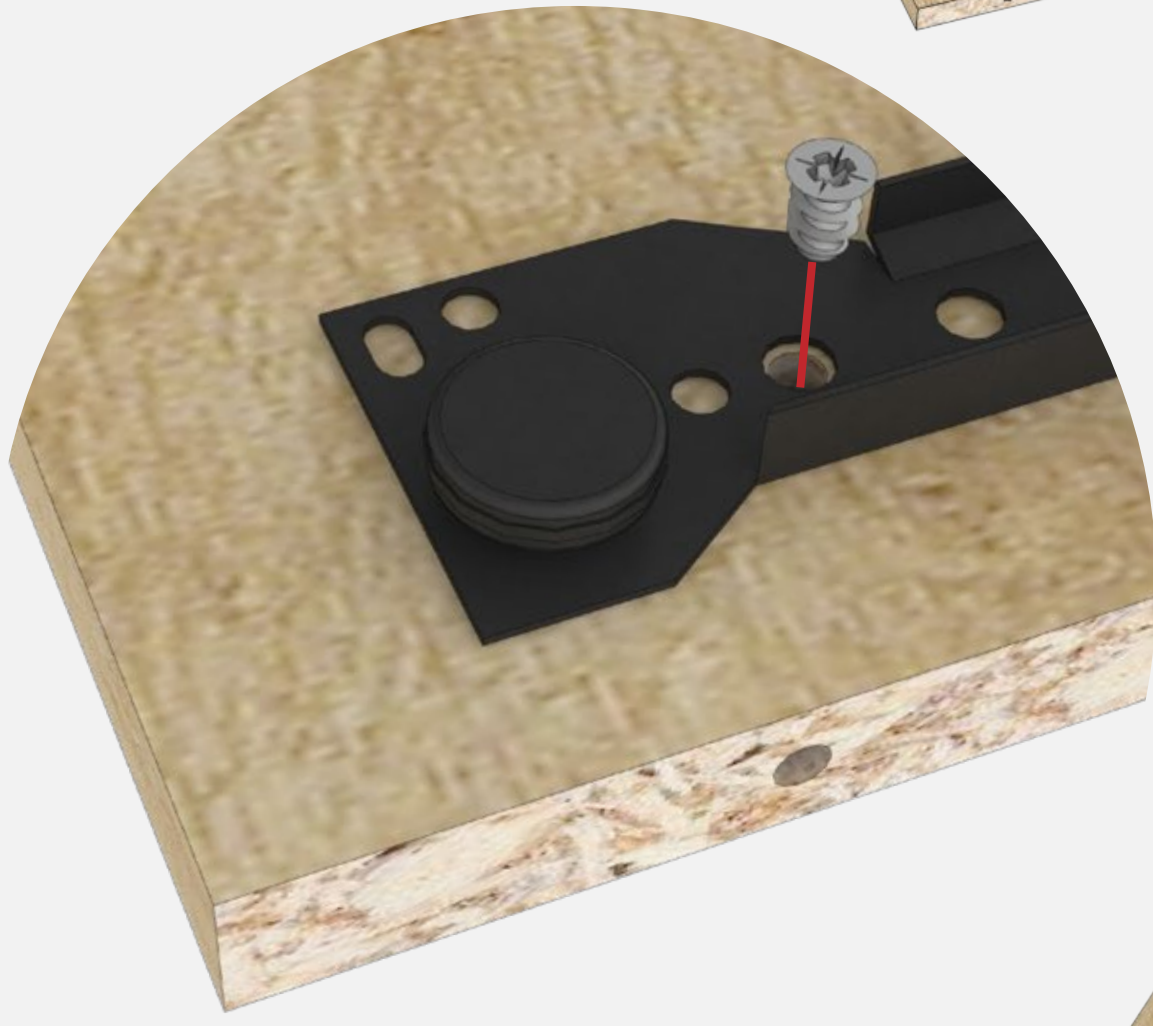

zoom

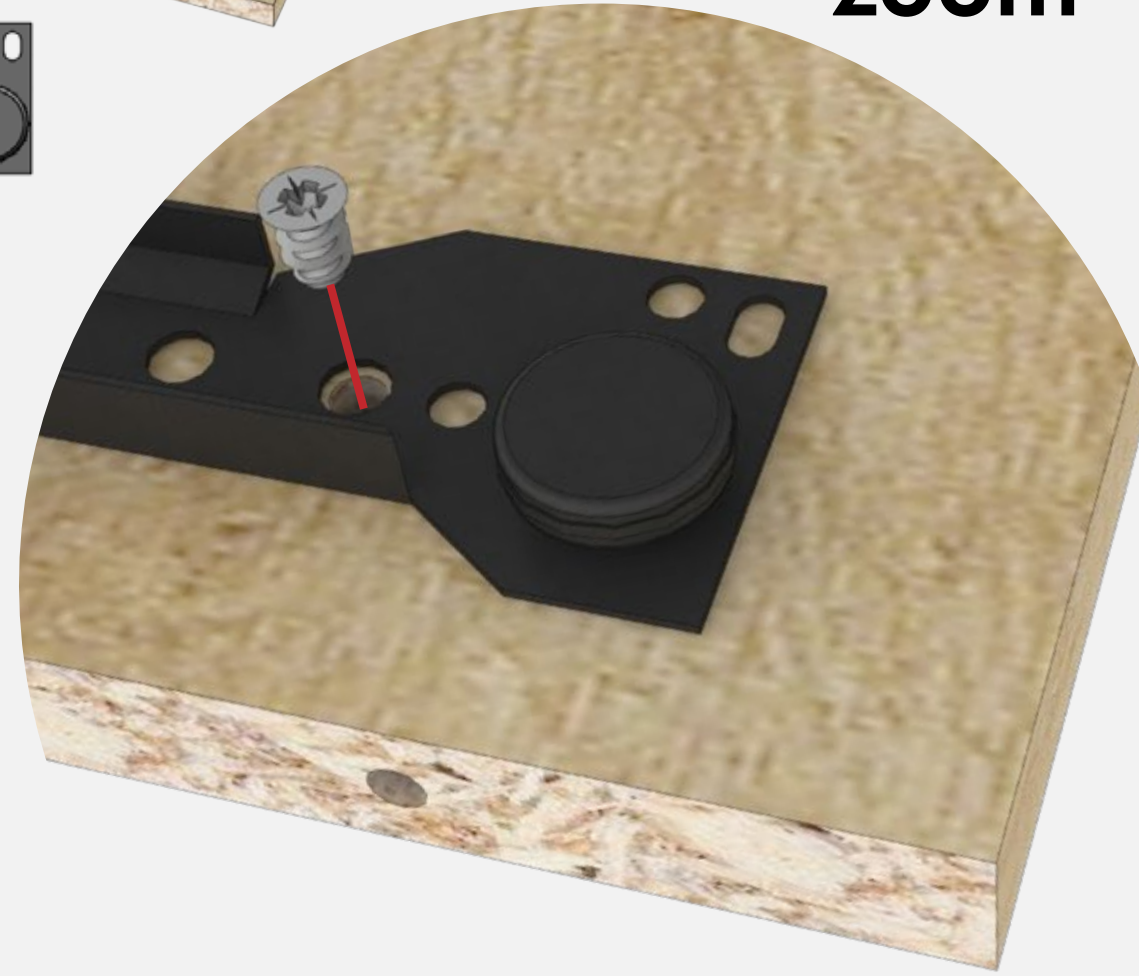

H5

H5

04

Armado de estructura

Vincular 2 costados y parante con las piezas base y techo mediante 12 tornillos confirmat.

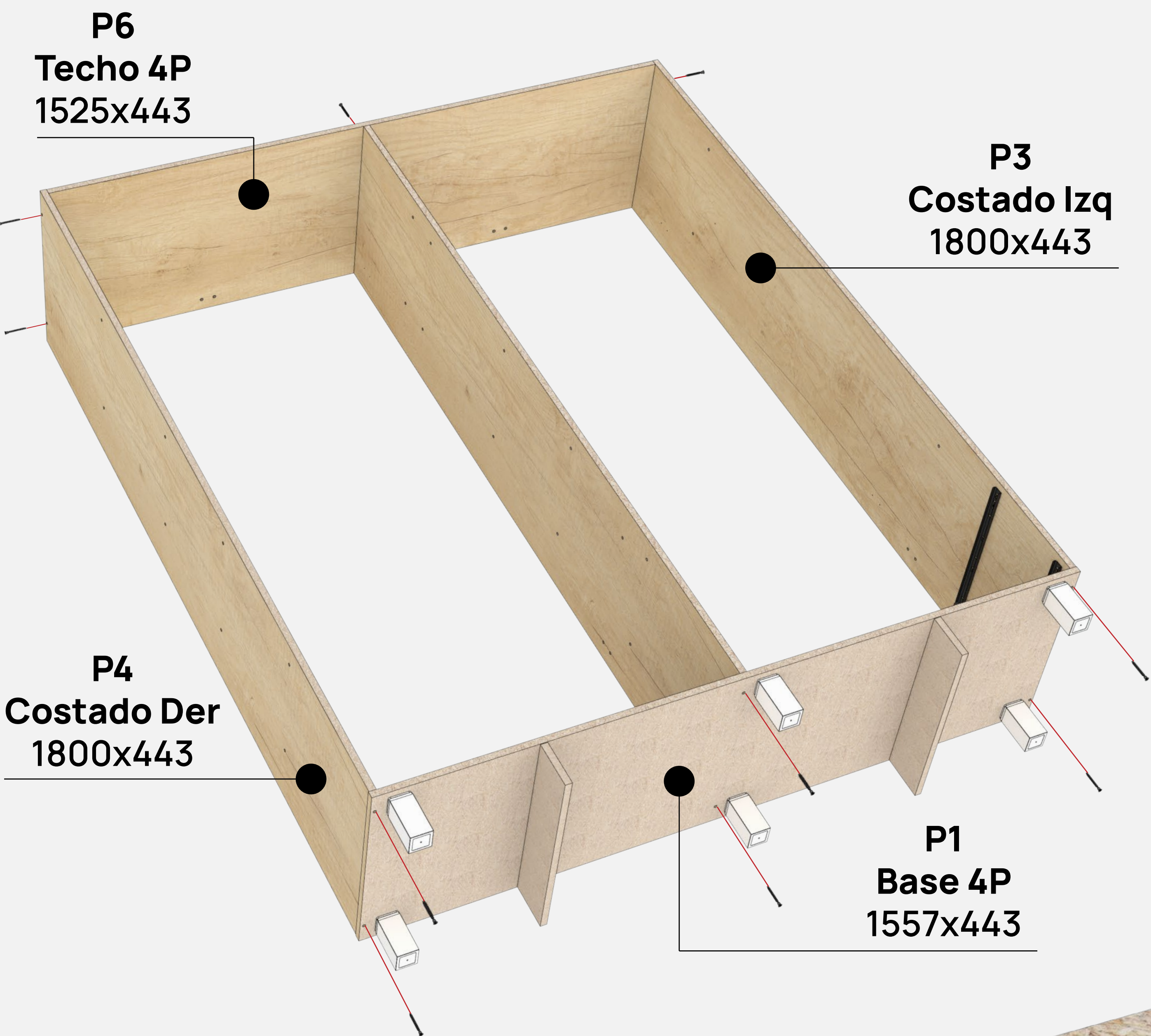

05

Vincular estantes

Sumar a la estructura 6 estantes y vincularlos con 4 tornillos allen cada uno.



P8
Estante largo
755x354

P7
Estante Caj
755x417

P8
Estante largo
755x354

H1
Tornillo
6.3x50 Allen



06

Colocar fondos

Corroborar que el mueble esté colocado en escuadra a 90° y clavar 4 fondos. Clavos cada 13 cm aprox.



zoom

H6
Clavo



Fondo
PL
1804x385

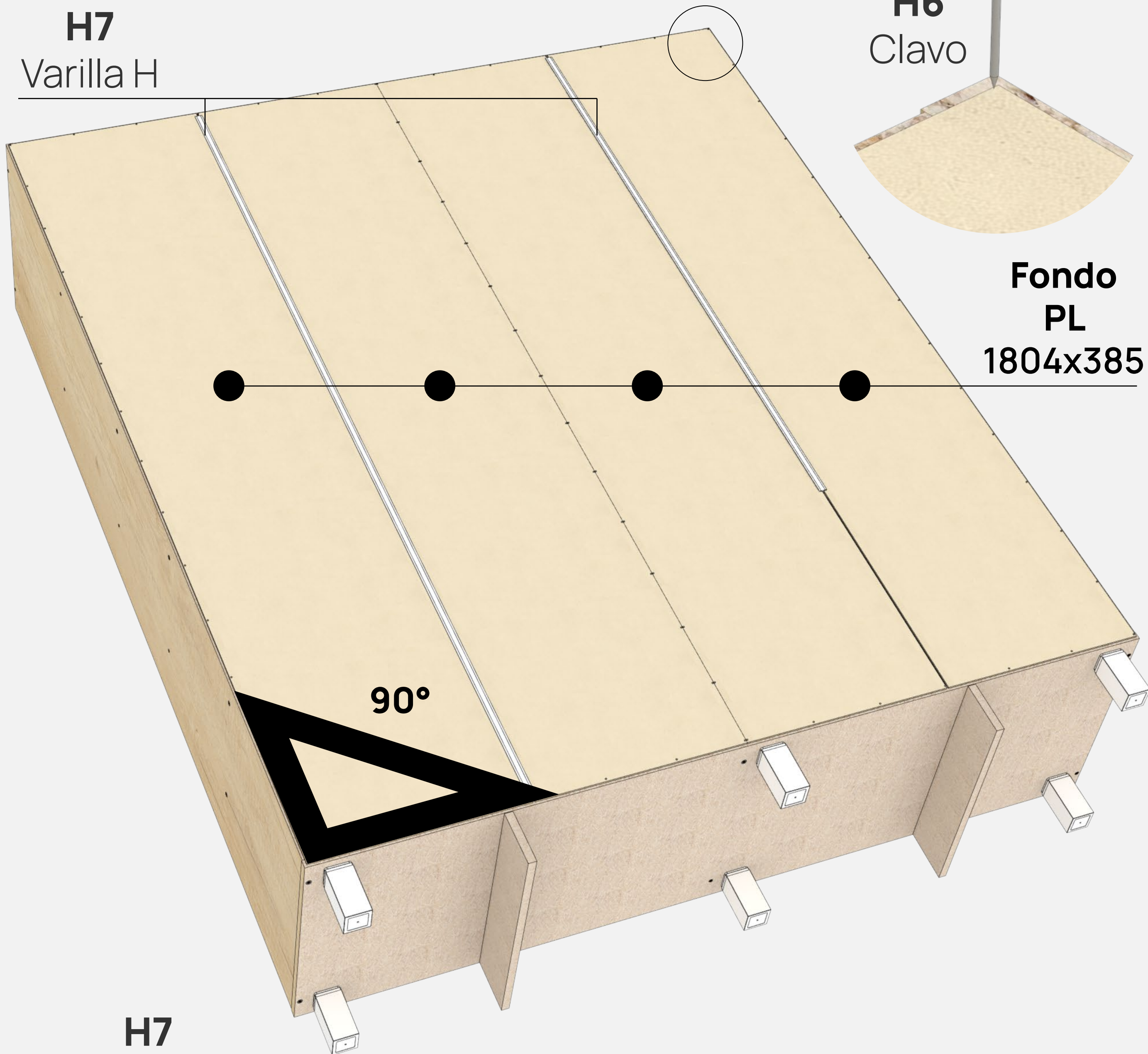

H7
Varilla H

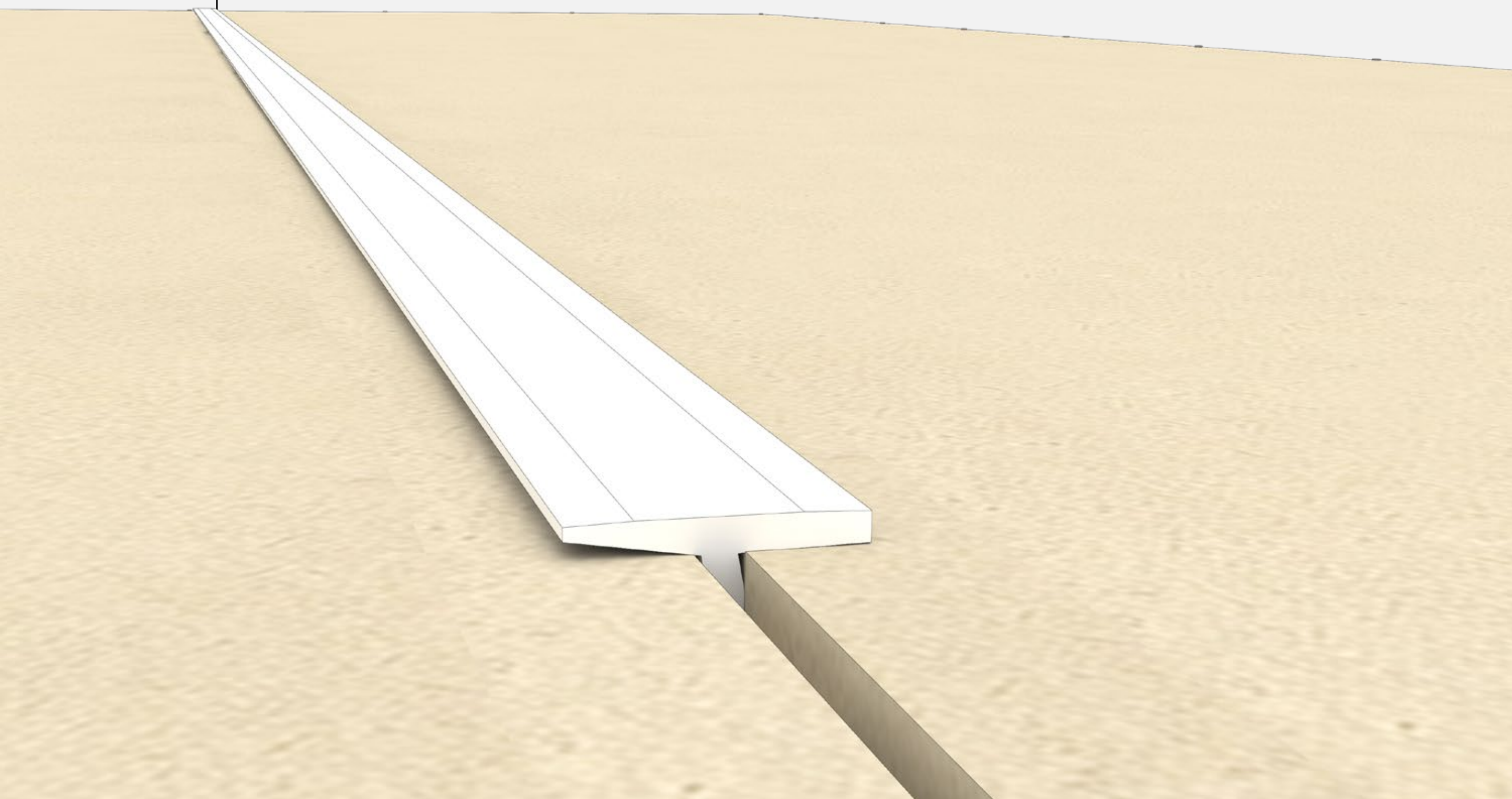

07

Paso importante!
Girar placard con soportes de
armado colocados para evitar
rotura de patas plásticas.



PASO A

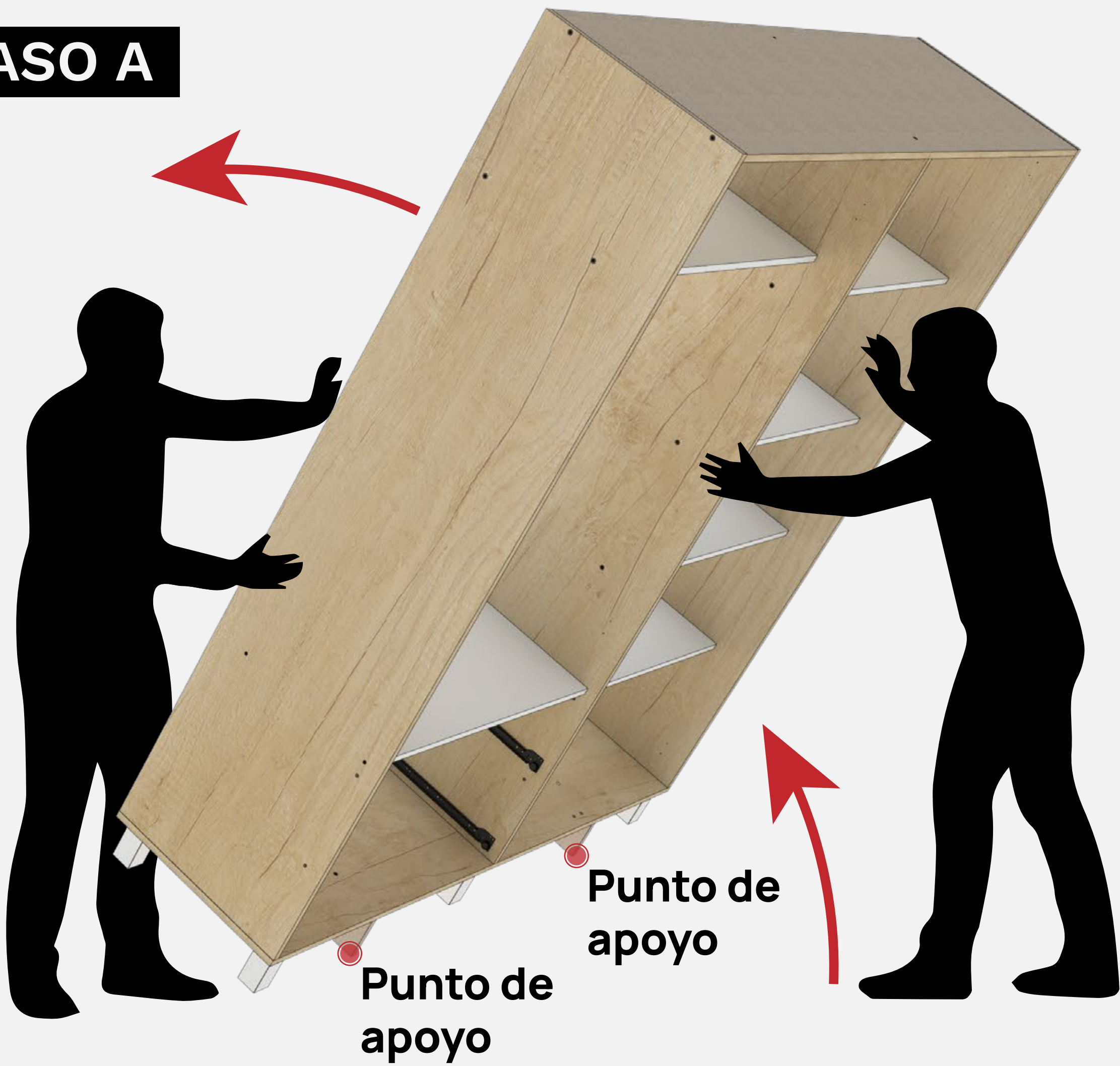

PASO B

Quitar 4 tornillos
de soportes y
empujar
levemente.

Luego
retirar
ambos
soportes!



08

Colocar fajas de cajón

Vincular 2 fajas cajón con 4 tornillos Allen. Los tornillos se usaron previamente para vincular soportes de armado.



H8
Soporte estante

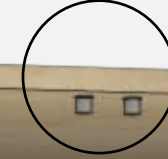
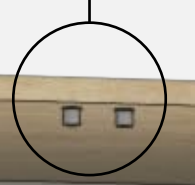

H10
Soporte Lat. barral

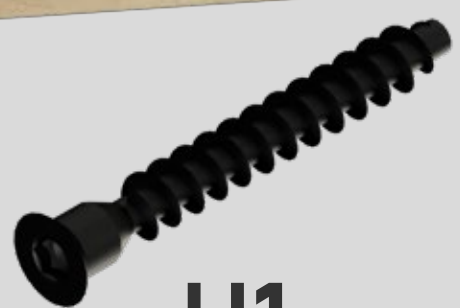
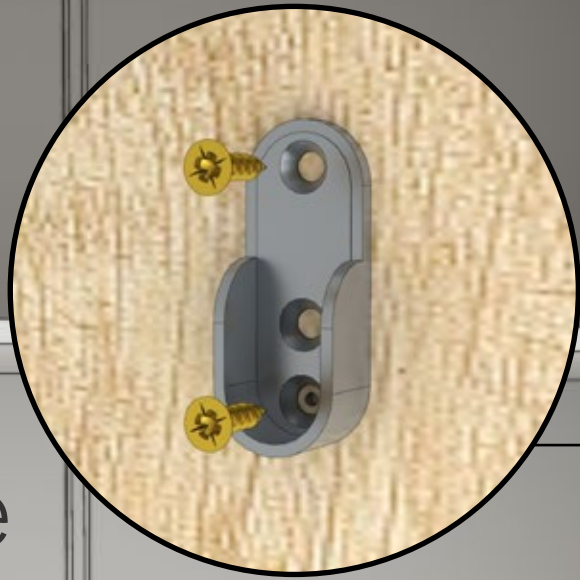

H1
Tornillo
6.3x50 Allen



H9
Tapón 6 mm

H8
Soporte estante



09

Frentes de cajones

Enroscar 2 pernos minifix,
hasta que hagan tope!

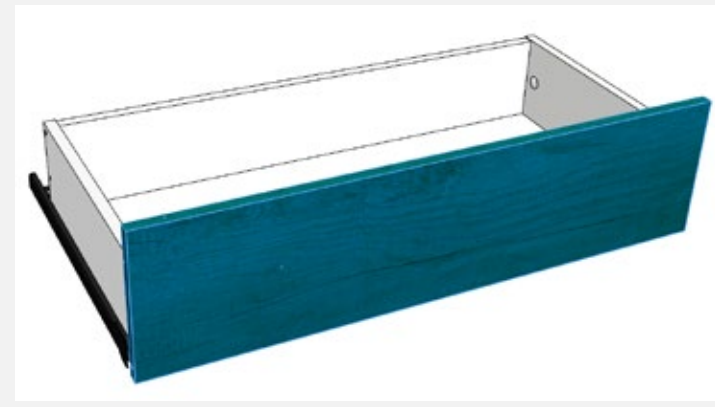

P11
Frente de cajón
748x189

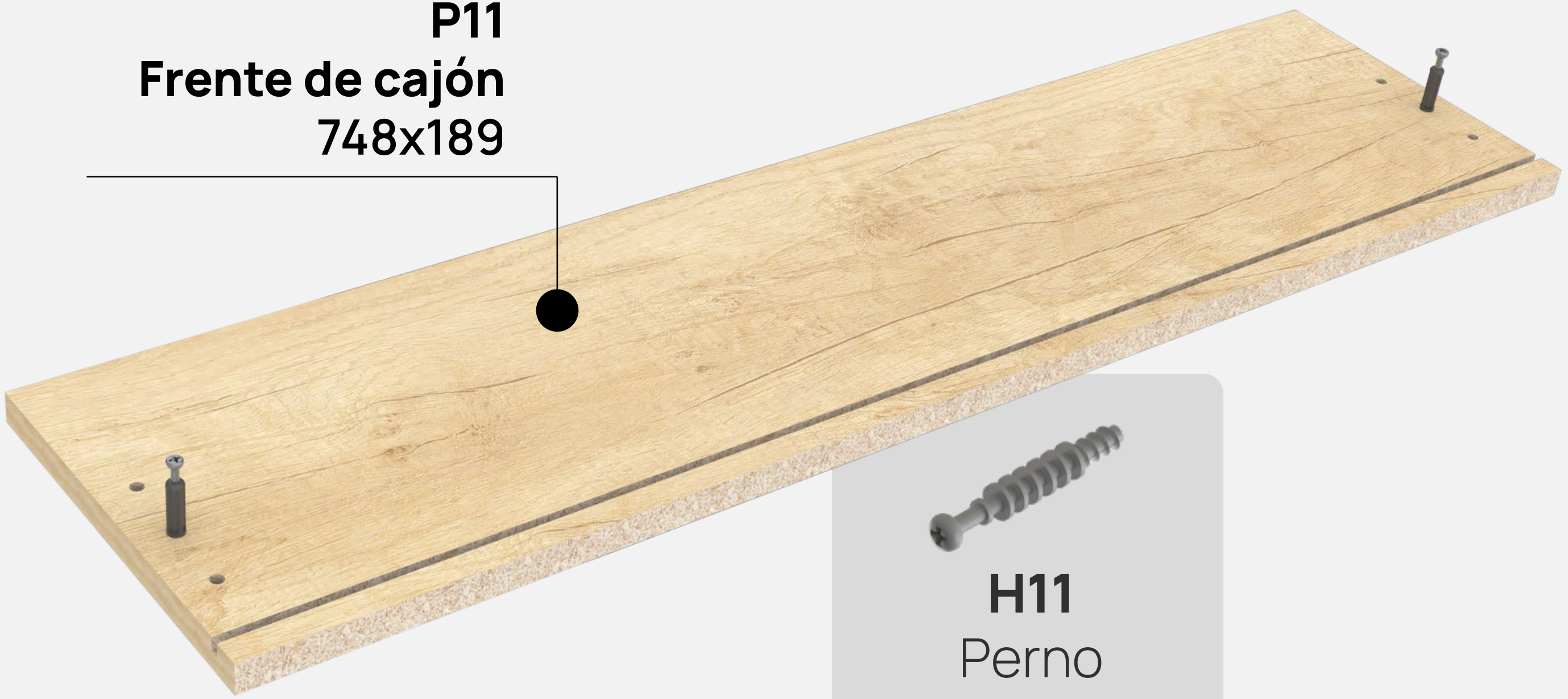

H11
Perno
minifix



Ajustar hasta
que haga **tope!**

10

Costado de cajón

Colocar a presión **cazoletas**,
tapones y **tarugos**.

Encolar perforaciones antes
de colocar tarugos.

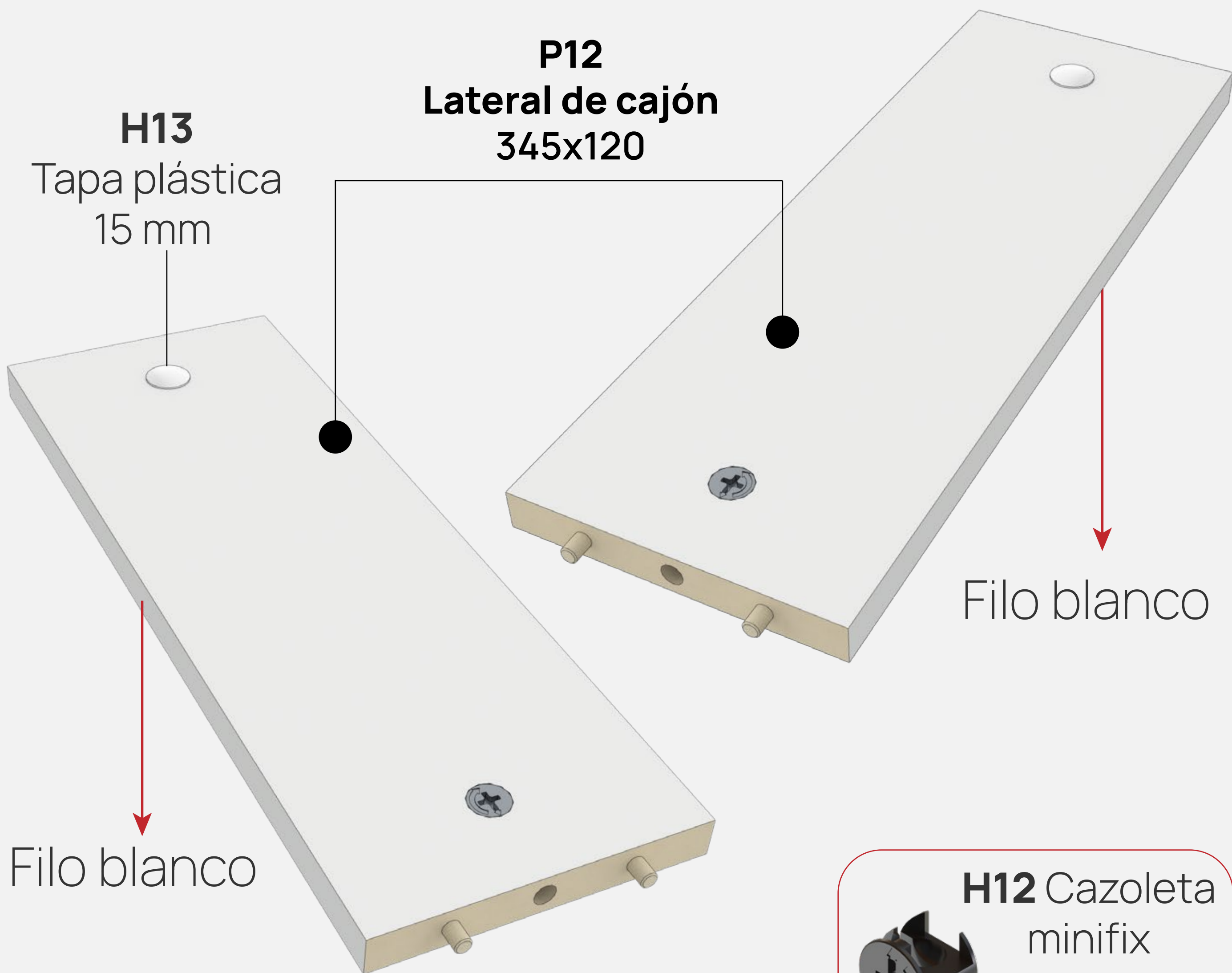
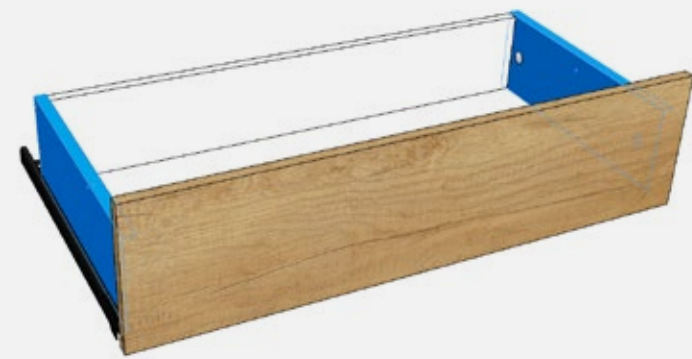

Colocar **cazoleta minifix** con la flecha
hacia apuntando hacia la perforación.

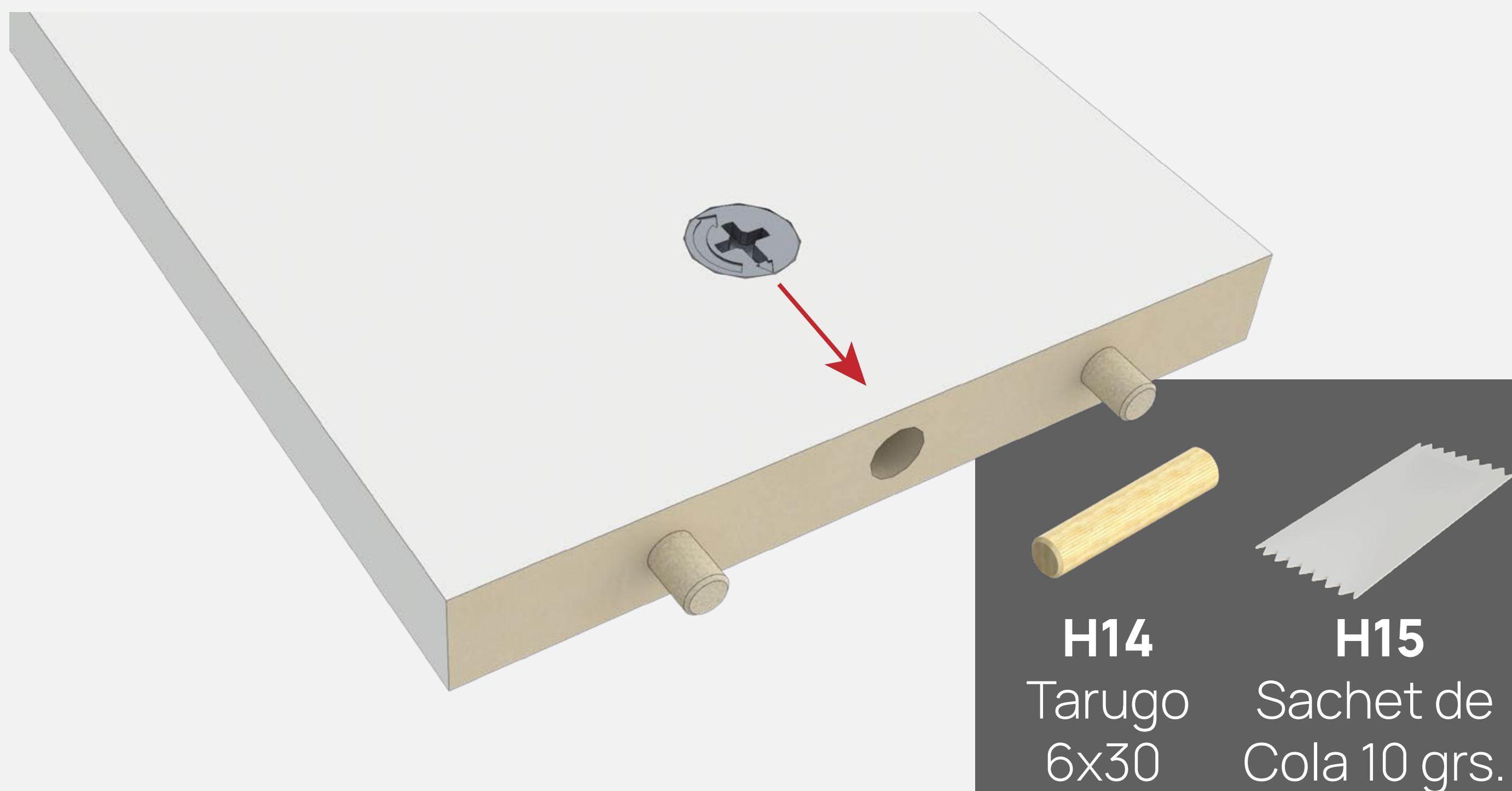

11

Armar cajones

Unir laterales de cajón con frente y contrafrente

Mantener cajón escuadrado a 90°



H19 Tornillo 3.5x30



Contrafrente
699x118

P12
Lateral de cajón

90°

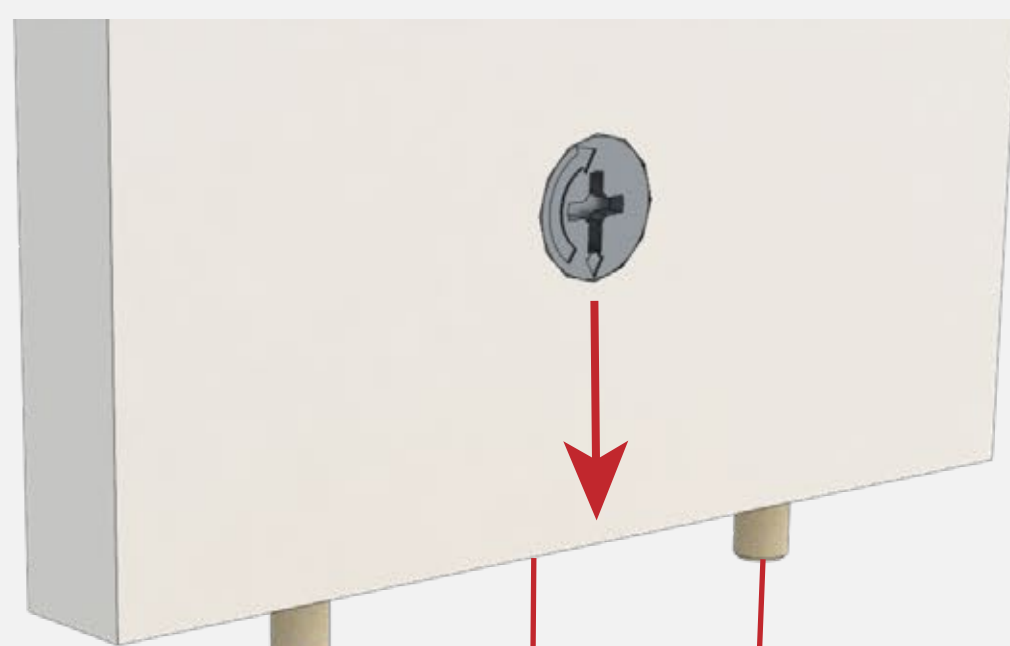

AJUSTAR 180°

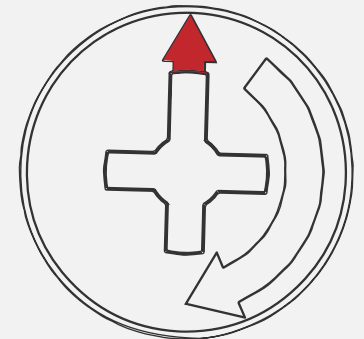
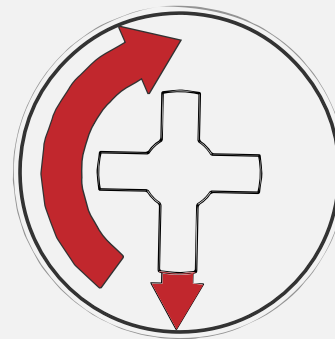

12

Colocar fondo

Clavar fondo de cajón. Es muy importante verificar escuadra a 90°. Clavos cada 12 cm. aprox

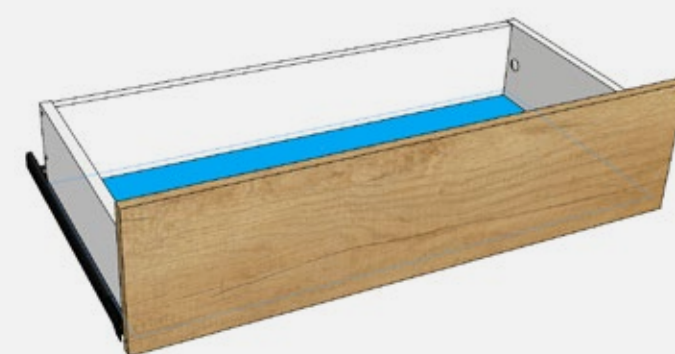

Fondo
cajón
727x352

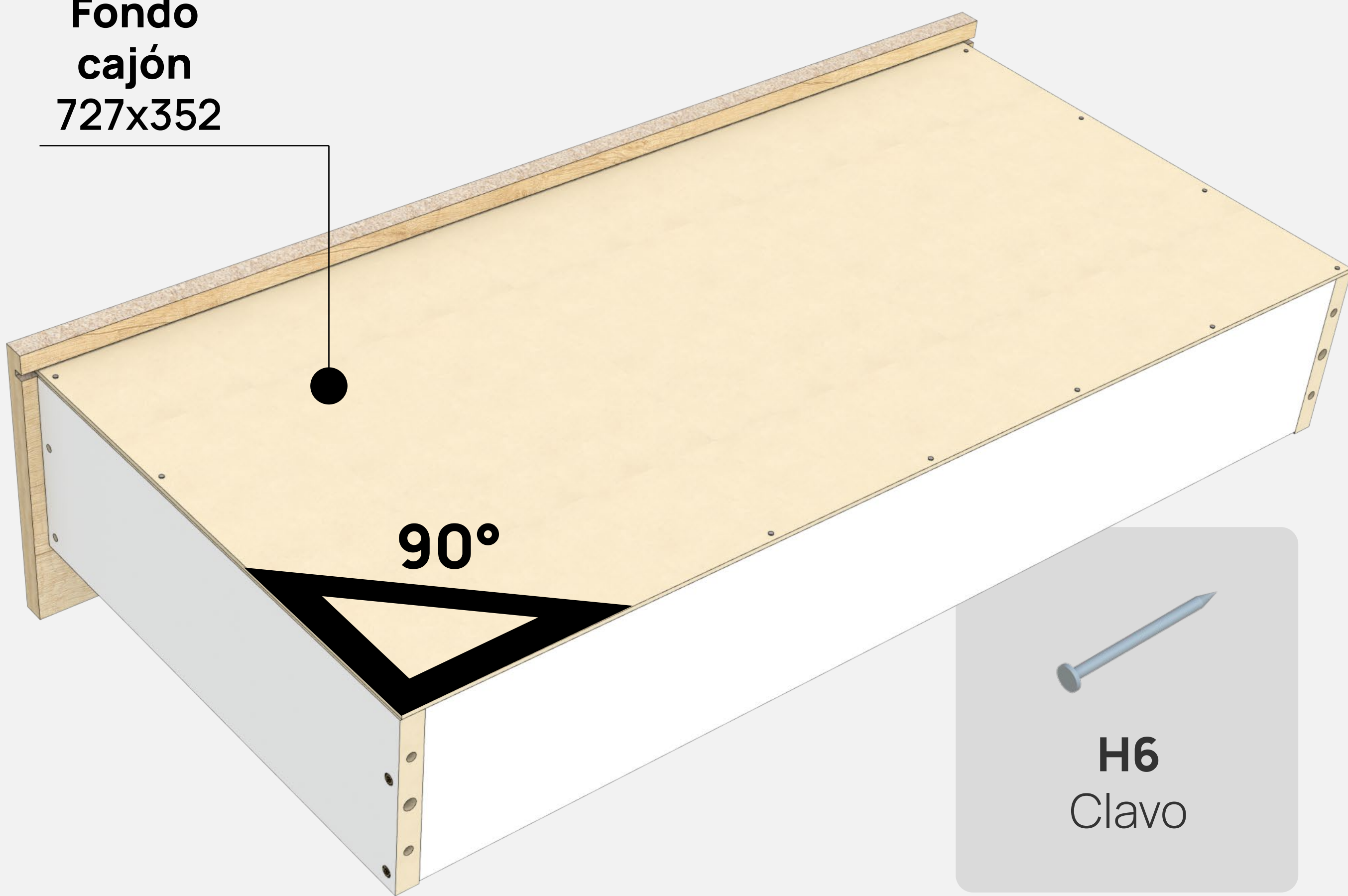

P11
Frente de cajón
748x189



Encastrar
fondo en
frente y
luego clavar

13

Colocar correderas

Colocar 2 correderas en Cajones.
Cada corredera se vincula
con **2 tornillos 3.5x15.**

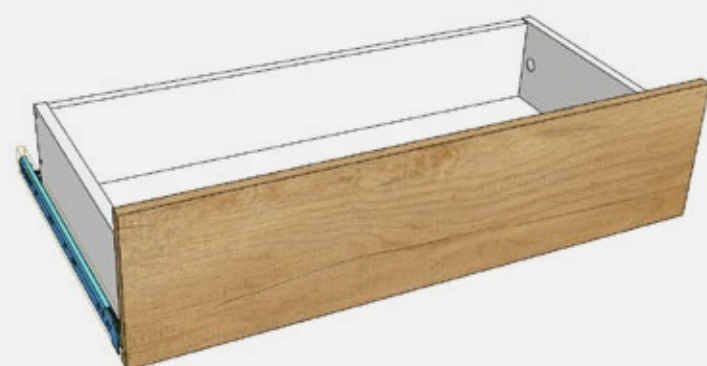

H4
Corredera
Z 400

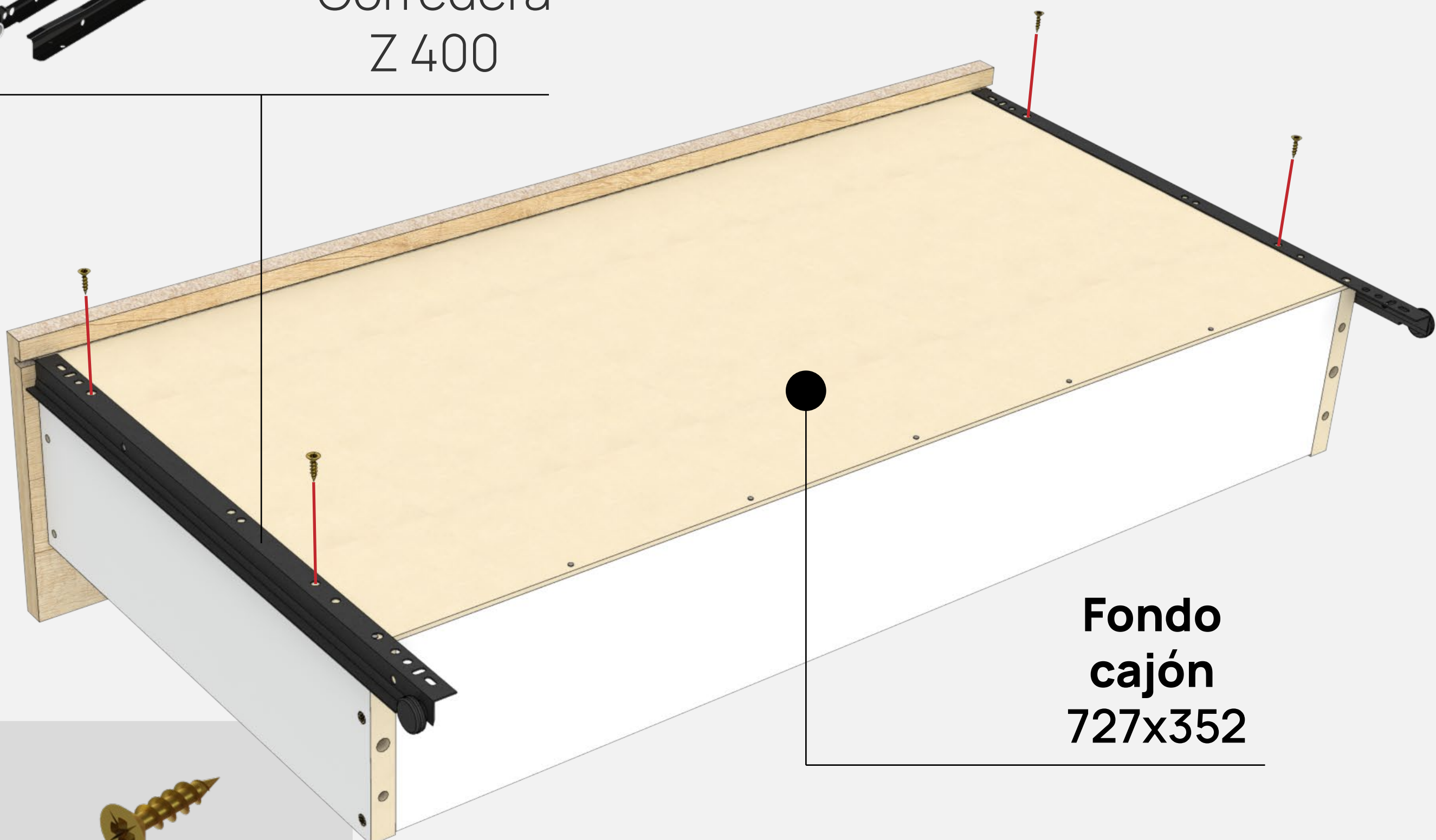

**Fondo
cajón
727x352**



H2
Tornillo
3.5x15



14

Armar 4 puertas

Colocar 3 bisagras y 1 manija en cada una de las puertas.

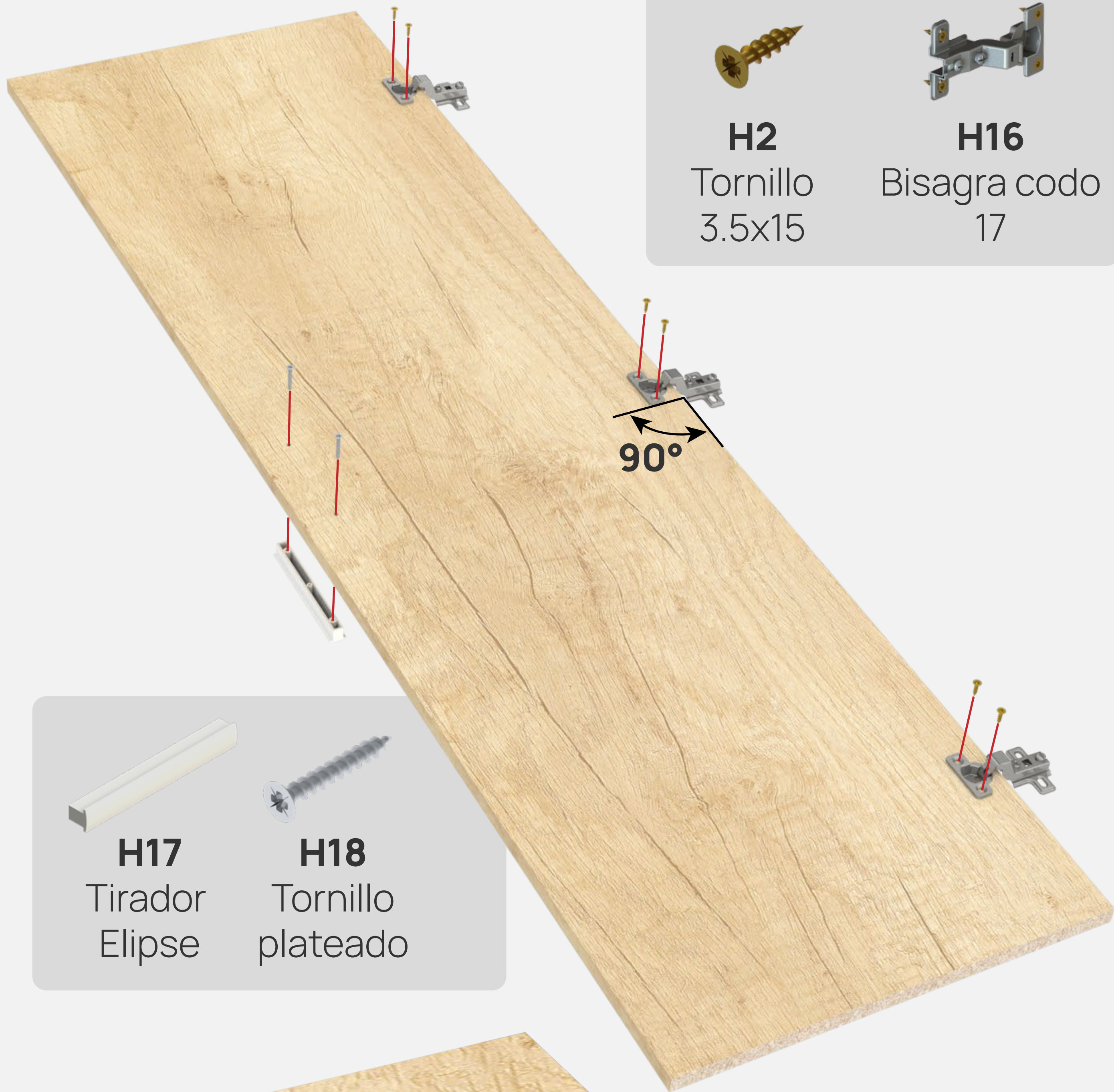

H2
Tornillo
3.5x15

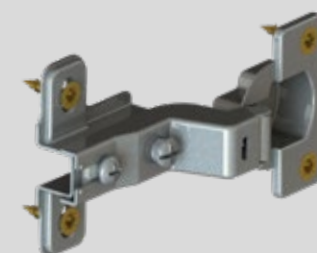

H16
Bisagra codo
17



H17
Tirador
Elipse

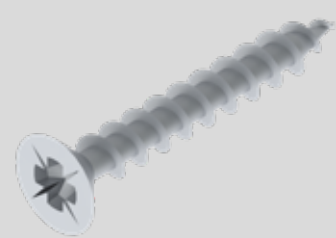

H18
Tornillo
plateado

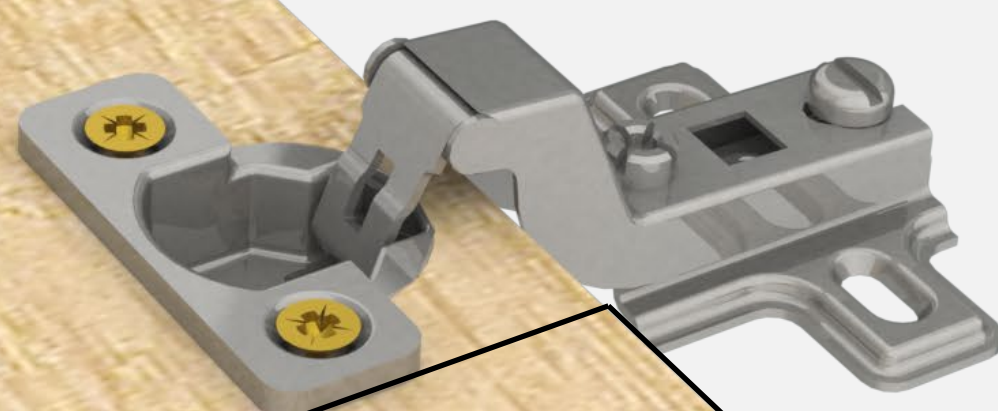

90°

15

Colgar puertas

Colgar 4 puertas y regular 12 bisagras.

Colocar barral de colgado.



H20
Barral
de colgado

P13
Puerta
corta
1327x372



P14
Puerta larga
1775x372

Tornillo para
ajuste frontal

Tornillo para
ajuste horizontal

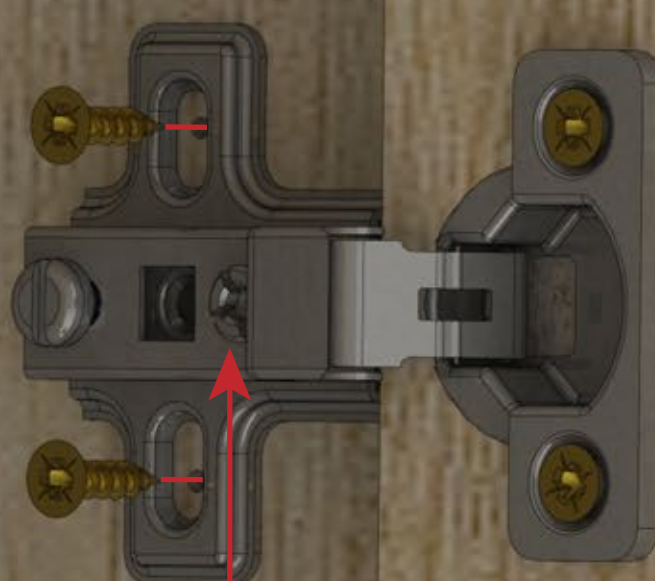

Las bisagras cuentan con 2 tornillos de regulación, que permiten alinear las puertas.

16

Último paso!

Deslizar cajones como indica el gráfico.

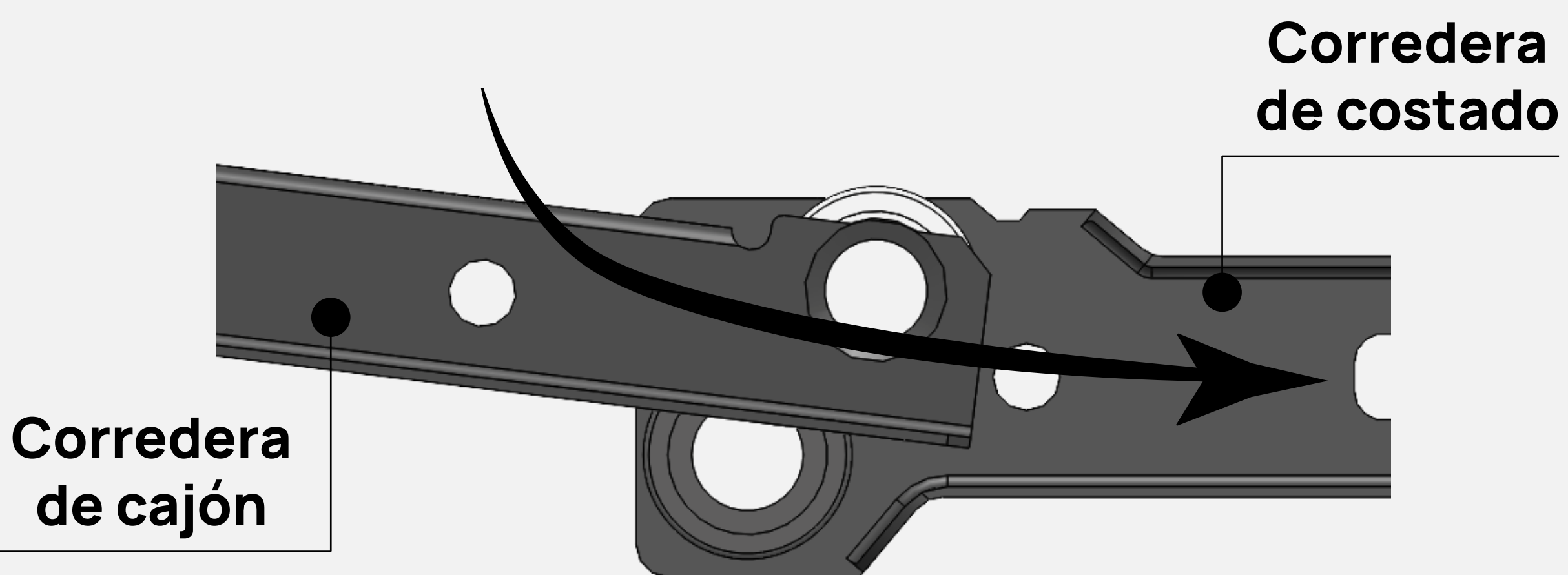

Terminaste!

Disfrutá tu Placard Geo

